

N3

N3

CREDITS

MARKETING DEPARTMENT

Anna Magni
Francesca Mauri

ART DIRECTION AND LAYOUT

Gag Srl Società Benefit

PHOTOGRAPHERS

Stefano Anzini
Daniele Cortese
Zvonimir Mihaljek
Andrius Pavelko
Max Rommel
Alessio Scaccabarozzi



Cariboni Group S.p.A.

SALES OFFICE AND WAREHOUSE

Via della Tecnica, 19
23875 Osnago (Lc)
Tel. +39 039 95211
info@caribonigroup.com

REGISTERED OFFICE AND FACTORY

Via G.A. Prato, 22
38068 Rovereto (Tn)
Tel. +39 0464 422247
info@caribonigroup.com

CARIBONI LITE FRANCE

Z.A DU Pré de la Dame Jeanne,
Avenue de la Dame Jeanne,
Zone 2 _ Bât J
60128 Plailly
Tel. +33 3 44740380
cariboni.lite@cariboni.fr

Product index

Agathos	430	Kono zoom NEW	72
Aplos	114	Kore	298
Bamboo	88	Kosmos	398
Bamboo mini NEW	88	Levante 2.0 NEW	206
Banister	308	Lit	464
Big Link	574	Lit xs	104
Chara	254	Mât Balancier	598
Classic	588	Mikro	326
Cube	242	Newton 2.0 NEW	628
Dual	366	Nodea	542
Ekleipsis	144	Omikron	174
Emi	318	Omikron mini	162
Fin	126	Omikron pro	184
Fin xs	136	One4two	350
Flat Link	560	Orao	548
Grace	264	Poli	358
Grapho	332	Sans Serif	342
Grapho mini NEW	332	Sigma	194
Iota	98	Sigma Street	490
Kai	614	Spoon NEW	46
Kairos	622	Themelio	524
Kalos	374	Trail	272
Kinetic NEW	230	Volta	500
Koinè NEW	606	Ypsilon	454

Bollard



Spoon
→ 46



Kono zoom
→ 72



Bamboo mini
→ 88



Bamboo
→ 88



Iota
→ 98



Aplos
→ 114



Lit xs
→ 104

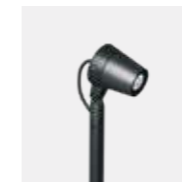

Omikron mini
→ 162



Ekleipsis
→ 144



Fin
→ 126



Fin xs
→ 136

Architectural floodlight

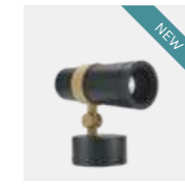

Kono zoom
→ 72



Kinetic
→ 230



Levante 2.0
→ 206



Omikron mini Flood
→ 162



Omikron Flood
→ 174



Omikron pro Flood
→ 184



Sigma Flood
→ 194



Lit Flood
→ 464



Kosmos Flood
→ 398



Cube
→ 242

Walk Over Recessed



Chara
→ 254



Grace
→ 264



Trail
→ 272

Drive Over Recessed



Grace
→ 264



Kore
→ 298

Ground



Bamboo mini
→ 88



Bamboo
→ 88



Chara
→ 254



Grace
→ 264

Wall



Spoon
→ 46



Kinetic
→ 230



Emi
→ 318



Mikro
→ 326



Grapho mini
→ 332



Grapho
→ 332



Sans Serif
→ 342



Lit xs
→ 104



Ekleipsis
→ 144



Bamboo mini
→ 88



Bamboo
→ 88



Cube
→ 242



One4two
→ 350



Banister
→ 308



Trail
→ 272

Wall Recessed



Aplos
→ 114



Chara
→ 254



Fin
→ 126



Fin xs
→ 136



Trail
→ 272

Ceiling



Kinetic
→ 230



Ekleipsis
→ 144



Trail
→ 272



Cube
→ 242

Ceiling Recessed



Chara
→ 254



Kore
→ 298



Ekleipsis
→ 144



Trail
→ 272

Post Top



Poli
→ 358



Dual
→ 366



Ekleipsis Pole
→ 144



Kosmos
→ 398



Kalos
→ 374



Ypsilon
→ 454



Agathos
→ 430

Pole Side



Spoon
→ 46



Kono zoom
→ 72



Levante 2.0 Poles
→ 206



Levante 2.0 Brackets
and poles → 206



Omikron mini Pole
→ 162

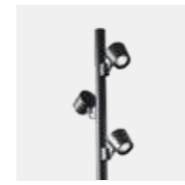

Omikron Pole
→ 174



Omikron pro Pole
→ 184



Sigma Pole
→ 194



Sigma Street
→ 490



Volta
→ 500



Themelio
→ 524



Lit System
→ 464



Lit Poles
→ 464



Lit Bracket and poles
→ 464



Kosmos
→ 398



Nodea
→ 542



Orao
→ 548



Kalos
→ 374



Agathos
→ 430



Flat link
→ 560



Big Link
→ 574



Classic
→ 588



Ypsilon
→ 454



Mât Balancier
→ 598

String Suspension



Levante 2.0
→ 206



Volta
→ 500

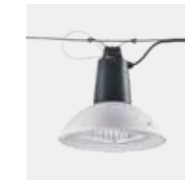

Themelio
→ 524



Kosmos
→ 398



Orao
→ 548



Kalos
→ 374



Flat Link
→ 560

Ceiling Suspension



Spoon
→ 46



Volta
→ 500



Themelio
→ 524



Kosmos
→ 398



Orao
→ 548



Kalos
→ 374



Agathos
→ 430

Street



Koiné
→ 606



Kai
→ 614



Kairos
→ 622



Newton 2.0
→ 628

Large Areas Floodlight

Associations



Associazione Italiana di Illuminazione.
Company of Italian Lighting Association.



FEDERLEGNOARREDO

Assoluce, associazione di FederlegnoArredo cui aderiscono le aziende italiane produttrici di apparecchi di illuminazione.

Assoluce, an association of FederlegnoArredo whose members are Italian lighting manufacturers.



Consorzio per la raccolta e lo smaltimento delle apparecchiature di illuminazione.

Consortium for collection and waste of lighting system equipments.



Associazione francese dei designer della luce e dell'illuminazione.

Company of French Lighting designer's Association.



UNI Ente Nazionale Italiano di normazione.

UNI Italian National Standardization Authority.



Associazione Nazionale Produttori Illuminazione.
National Association Lighting Manufacturer.



UAI: Certificazione rilasciata dall'Associazione Unione Astrofili Italiani agli apparecchi valutati anti-inquinamento luminoso.

UAI: Certification issued by the Italian Astronomy Lovers Union association for those fixtures which are esteemed as "anti-lighting-pollution".



Società Italiana Gallerie.
Italian Tunnelling Society.



Confederazione generale dell'industria italiana.
General Confederation of Italian Industry



Cariboni
group

Una forte passione per la luce
e un costante impegno nella
ricerca e nell'innovazione

Cariboni è stata fondata da Osvaldo Cariboni nel 1908 in Lombardia per produrre accessori per linee elettriche. Dal 1965 l'azienda sviluppa con originalità importanti innovazioni tecnologiche nel settore dell'illuminazione e ha acquisito nel tempo profonda esperienza nella gestione dei corpi illuminanti.

Ci distingue una forte passione per la luce e un costante impegno nella ricerca e nell'innovazione.

Offriamo soluzioni per l'illuminazione di piccoli borghi e grandi città: piste ciclabili e pedonali, percorsi veicolari, piazze, aree verdi e architetture; spazi per il lavoro e il tempo libero, per la cultura e il benessere, per lo sport e la mobilità.

Ogni nostra soluzione è un sistema coerente che consente al progettista di combinare differenti distribuzioni fotometriche, metodi di fissaggio e opzioni di gestione del flusso luminoso per rispondere al meglio a ogni esigenza.

Cariboni was founded by Osvaldo Cariboni in 1908 in Lombardy to produce accessories for power lines. Since 1965 the company has developed numerous important and original technological lighting sector innovations, as well as gaining in-depth experience in light system management.

A genuine passion for lighting and a constant commitment to research and innovation are our cutting edge.

We offer solutions for lighting small towns and big cities: cycle and pedestrian paths, vehicle routes, squares, parks and gardens, architectures; workspaces and areas for leisure, culture and well-being, for sport and mobility.

All our solutions are part of a cohesive system that allows designers to combine different photometric distributions, installation methods and light flow management options to meet every single requirement more effectively.

A genuine passion for lighting
and a constant commitment to
research and innovation





Proteggere la notte e preservare i naturali ritmi biologici di flora e fauna

Sostenibilità sociale e ambientale

Riconosciamo come valore fondamentale la gentilezza, sia verso il territorio in cui operiamo che nei confronti dell'intero pianeta e di tutta la vita che lo abita.

Collaboriamo con enti e istituzioni locali a vantaggio della comunità di cui ci sentiamo parte. Sosteniamo eccellenze nazionali, soprattutto negli ambiti della creatività e della ricerca tecnologica.

Valutiamo ogni scelta progettuale e produttiva nel rispetto dell'ambiente. Realizziamo sistemi d'illuminazione in grado di ottimizzare i consumi energetici e illuminare solo dove e quando la luce serve. Limitiamo l'inquinamento luminoso per proteggere la notte e preservare i naturali ritmi biologici di flora e fauna. I nostri prodotti sono durevoli e affidabili e in ogni fase di sviluppo ottimizziamo l'uso di materiali e risorse.

Social and environmental sustainability

We acknowledge that consideration is a fundamental value, not just for the area where we operate, but for the entire planet and all the life that occupies it. We collaborate with local authorities and institutions to benefit the community we feel part of. We support national excellence, especially in the areas of creativity and technological research.

Every design and production decision we make is based on an assessment of its capacity to respect the environment, and we make lighting systems that optimise energy consumption and only illuminate when and where light is needed. We limit light pollution to protect the night and conserve the natural biological rhythms of flora and fauna. Our products are durable and reliable, and we rationalise the use of materials and resources throughout every stage of development.

Protect the night and conserve the natural biological rhythms of flora and fauna

Made in Italy

Tutte le fasi di progettazione e produzione si svolgono da sempre in Italia, negli stessi luoghi in cui abbiamo iniziato nel 1908, e in sinergia con una fitta rete di imprese locali con cui abbiamo instaurato nel tempo solide relazioni di fiducia. Consideriamo importante circoscrivere le attività nel nostro territorio per poter incontrare i nostri collaboratori.

Promuoviamo il "Made in Italy" proponendo innovazione e qualità nell'illuminazione urbana e nutrendo il nostro saper fare.

Made in Italy

All stages of design and production have always taken place in Italy, in the same places where we started in 1908, in synergy with a tight network of local companies with which we have established solid relationships of trust over time. We consider it important to limit activities to the local area so that we can meet with our collaborators.

We promote "Made in Italy" by offering innovative, high-quality urban lighting and by nurturing our know-how.



Progettazione ottica

Il sistema ottico di un apparecchio permette di plasmare la luce emessa dalla sorgente ed è l'essenza dei nostri prodotti. Sviluppiamo ottiche dedicate alle differenti geometrie urbane e siamo attenti alle esigenze di ogni area geografica di nostro interesse. Il progetto di ogni sistema ottico è seguito da un team interno composto da risorse specializzate in ottica, optoelettronica e ricerca di materiali che collabora con Optics Lite, la società del gruppo che si occupa dal 2004 della progettazione e della produzione di ottiche per il settore illuminotecnico.

Ricerca, Sviluppo e Validazioni

Il design dei nostri prodotti consiste in un progetto integrato di aspetti ottici, elettronici e meccanici. Definiamo aspetti formali e funzionali dopo un'attenta analisi dei possibili contesti applicativi e la valutazione delle relazioni che il sistema di illuminazione avrà con le persone e con l'ambiente. Negli ultimi anni, grazie alla crescente esperienza e allo sviluppo tecnologico, abbiamo incrementato i livelli di robustezza sia dal punto di vista meccanico che elettrico. Nei nostri laboratori eseguiamo test di validazioni a condizioni estreme per una maggiore garanzia di affidabilità.

Optical design

The optical system of a light fitting is able to mould the light emitted by the source, making it the essence of our products. We develop optics dedicated to the different urban geometries and are sensitive to the needs of every geographical area we are involved in. The design of each optical system is followed by an internal team made up of resources specialising in optics, optoelectronics and material research, which collaborates with Optics Lite, the group company that has been involved in designing and producing optics for the lighting sector since 2004.

Research, Development and Validation

Our products are based on the integrated design of optical, electronic and mechanical aspects. We define formal and functional aspects after carefully analysing possible application contexts and assessing how the lighting system will interact with people and the environment. Growing experience and technological development in recent years has allowed us to increase both the mechanical and electrical robustness of our products. In our laboratories, we perform validation tests under extreme conditions to guarantee greater reliability. development process improves information and material flows for greater speed and production flexibility.





Processo produttivo

EsercitiAMO accurati controlli della corretta esecuzione di ogni fase e adoperiamo linee di assemblaggio automatizzate che garantiscono la ripetibilità e la correttezza delle operazioni di montaggio. Un software per la gestione dei processi logistici mappa i flussi di materiale. I controlli dei materiali in ingresso vengono effettuati secondo piani statistici e tramite una valutazione del grado di servizio dei fornitori. I controlli funzionali e di sicurezza sono eseguiti sul 100% dei prodotti. La tracciabilità e la rintracciabilità di componenti e prodotti finiti è garantita da un sistema di identificazione seriale.

Production process

We perform thorough checks to ensure that each stage is carried out correctly, and we use automated assembly lines to guarantee that the manufacturing process is repeatable and correct. Software maps the material flows to manage the logistics processes. Incoming material checks are carried out in accordance with statistical plans and the service level of suppliers is assessed. Functional and safety checks are carried out on 100% of the products. A serial number identification system ensures that components and finished products are traceable.

Zero-sprechi

Crediamo che eliminare gli sprechi sia sempre la scelta giusta. Negli ultimi anni abbiamo ridefinito e standardizzato i nostri metodi e strumenti operativi per eliminare le inefficienze ad ogni livello, dall'ideazione di un nuovo prodotto fino alla sua consegna al cliente. Il nuovo processo di sviluppo zero-sprechi migliora i flussi di informazioni e di materiali a vantaggio della velocità e della flessibilità produttiva.

Zero waste

We believe that eliminating waste is always the right choice. In recent years we have redefined and standardised our methods and operational tools to eliminate inefficiencies at every level, from conception of a new product to its delivery to the customer. The new zero-waste development process improves information and material flows for greater speed and production flexibility.

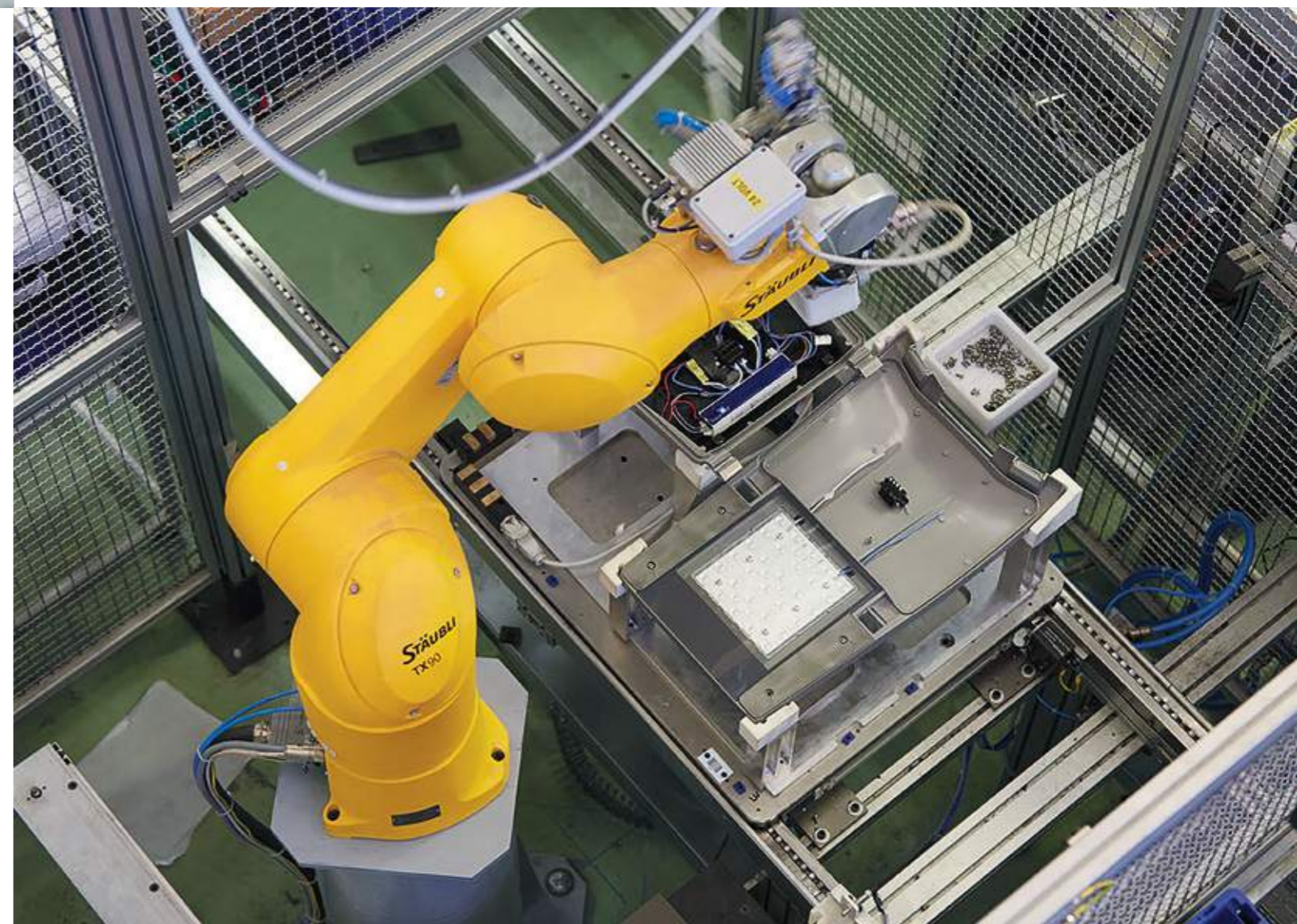



ECO-CENTRIC LIGHTING

Eco-Centric Lighting è l'approccio alla progettazione illuminotecnica degli spazi esterni che mira a tutelare la biodiversità e il benessere umano. Le nostre soluzioni limitano l'inquinamento luminoso e garantiscono la sicurezza e il comfort visivo delle persone.

Eco-Centric Lighting is an approach to the lighting design of outdoor spaces that aims to protect biodiversity and human well-being. Our solutions limit light pollution and ensure people's safety and visual comfort.



DISCOVER MORE

DARK FRIENDLY LIGHT

L'illuminazione artificiale notturna è una necessità per l'uomo ma è anche una concreta minaccia per i ritmi biologici naturali di flora e fauna. Le soluzioni Dark Friendly possono preservare il buio della notte e limitare l'inquinamento luminoso offrendo al progettista:

- luce calda secondo necessità: dal bianco neutro all'ambra
- luce quando serve: intelligente e adattiva
- luce dove serve: diretta verso il basso
- luce quanto serve: regolabile e minimizzata

Artificial lighting at night is a need for humans but is also a real threat to the natural biological rhythms of flora and fauna. Dark Friendly solutions can preserve the darkness of the night and limit light pollution offering to designer:

- light warm as needed: from neutral white to amber
- light when is needed: smart and adaptive
- light where is needed: downward directed
- light how much is needed: adjustable and minimized



BLUE FREE LIGHT

I sistemi ottici Blue Free riducono il contenuto di blu della luce bianca e generano un'atmosfera calda e accogliente per le persone. Sono ideali per illuminare spazi e percorsi di notevole interesse ecologico e prevalentemente frequentati da pedoni o ciclisti.

Blue Free optical systems reduce the blue content of white light and generate a warm and welcoming atmosphere for people. They are ideal for lighting spaces and paths of significant ecological interest and mainly used by pedestrians or cyclists.

PHOSPHOR CONVERTED AMBER (PCA) LED

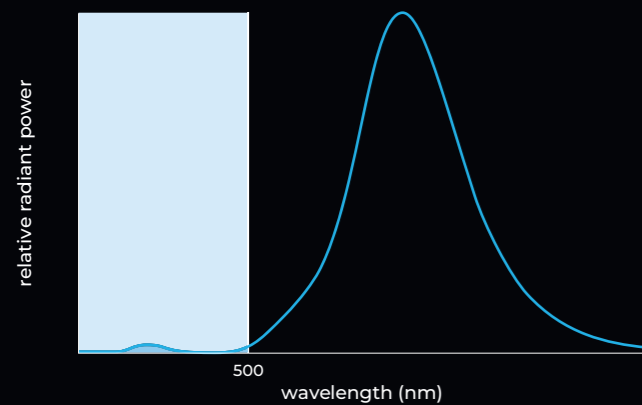

1800K LED

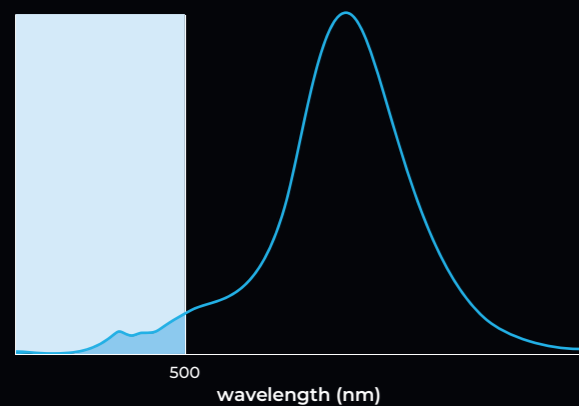

DISCOVER MORE



SWITCHABLE WHITE LIGHT

I sistemi ottici Switchable White alternano una luce ambrata a ridotto contenuto di blu (CCT=1800K), che protegge la flora e la fauna, con una luce bianca calda (CCT=3000K), che migliora le prestazioni visive umane quando il traffico è più intenso. Questa soluzione è ideale per illuminare spazi e percorsi ibridi, ecologicamente interessanti ma anche percorribili da veicoli.

The Switchable White optical systems alternate an amber light with reduced blue content (CCT=1800K), which protects the flora and fauna, with a warm white light (CCT=3000K), which improves human visual performance when traffic is heavier. This solution is ideal for lighting hybrid spaces and paths, which are ecologically interesting but also traveled by vehicles.

3000K LED

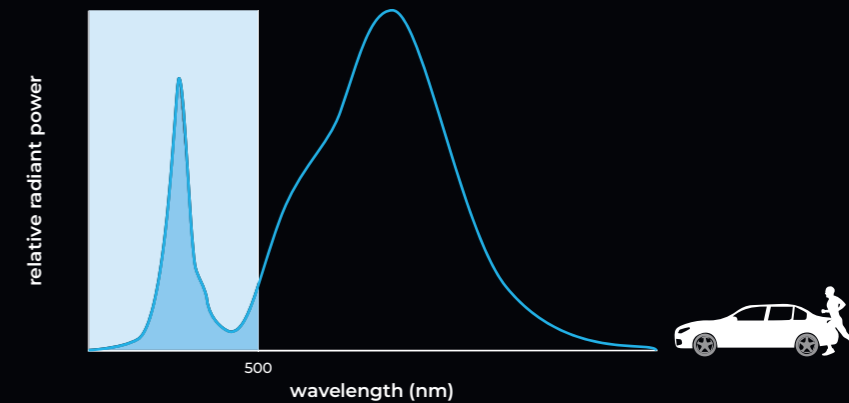

1800K LED

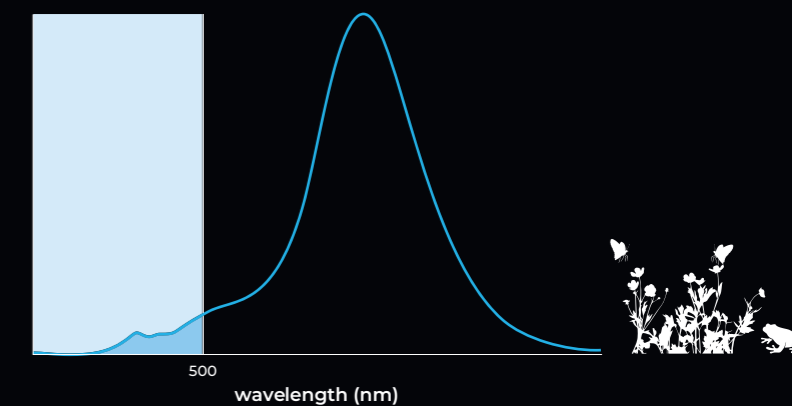

OTTICHE / OPTICS

ST-02 Narrow street
L / H = 0,75

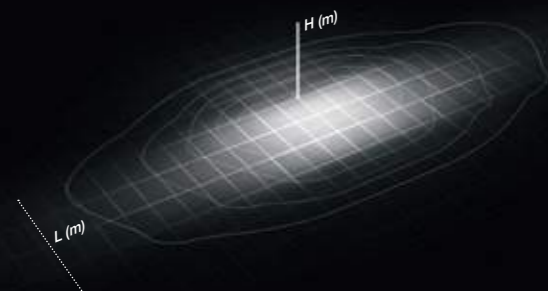

ME-05 Medium street
L / H = 1

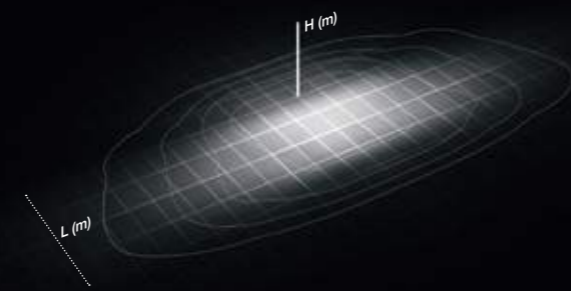

ME-06 Medium street with sidewalk
L / H = 1

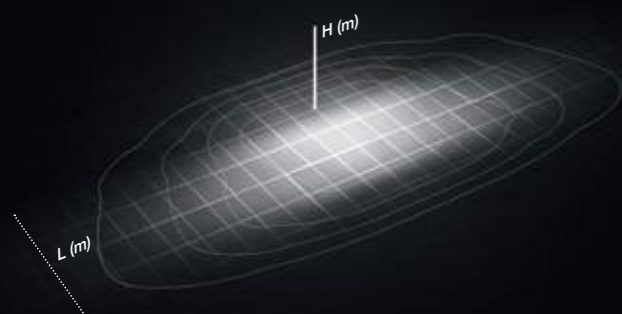

LA-03 Wide street
L / H = 1,25

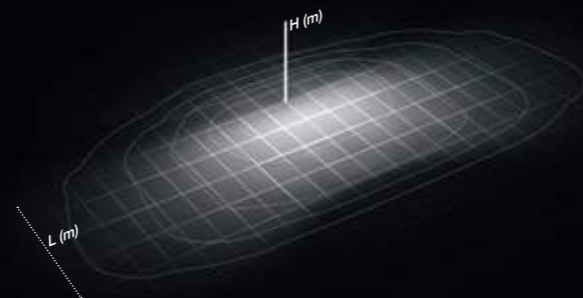

LT-63 Asymmetric beam
L / H = 2

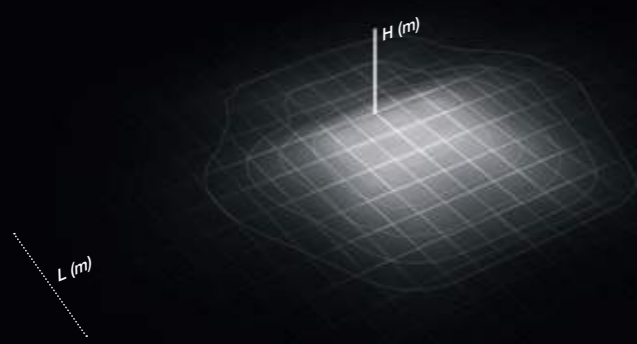

LT-64 Asymmetric beam with backlight
L / H = 2

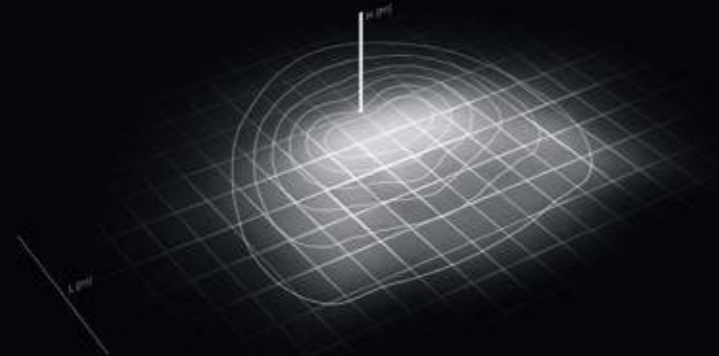

ECO-CENTRIC LIGHTING
SWITCHABLE WHITE LIGHT

● 1800 K / 3000 K

BLUE FREE LIGHT

● 1800 K ● PC-AMBER

ECO-CENTRIC LIGHTING

(ONLY FOR STREET OPTICS)

BLUE FREE LIGHT:

PC-AMBER 0,7% ΣR ($\lambda < 500\text{NM}$) _ CRI 40

1800 K 4,3% ΣR ($\lambda < 500\text{NM}$) _ CRI 70

SWITCHABLE WHITE LIGHT:

1800K / 3000K

COLOURFUL URBAN NIGHTS

I colori strutturano lo spazio e cambiano la percezione di un ambiente, con effetti sulla nostra reazione emotiva e risposta comportamentale. La luce colorata nel contesto urbano, se ben progettata, è un efficace strumento narrativo. Durante le ore di buio può svelare uno spazio urbano enfatizzando i suoi elementi costitutivi, alterare la realtà trasformando un paesaggio o raccontare storie attraverso l'eloquente dimensione semantica del colore. I colori comunicano infatti valori e significati che, pur variando nel tempo e nello spazio, rappresentano un linguaggio condiviso capace di attribuire nuovi significati allo spazio e alle architetture.

Colours structure space and change the perception of an environment, with effects on our emotional reaction and behavioral response. Coloured light in an urban context, if well designed, is an effective narrative tool. During the hours of darkness it can reveal an urban space by emphasizing its constituent elements, alter reality by transforming a landscape or tell stories through the eloquent semantic dimension of colour. In fact, colours communicate values and meanings which, although they change over time and space, represent a shared language that can give new meanings to space and architecture.

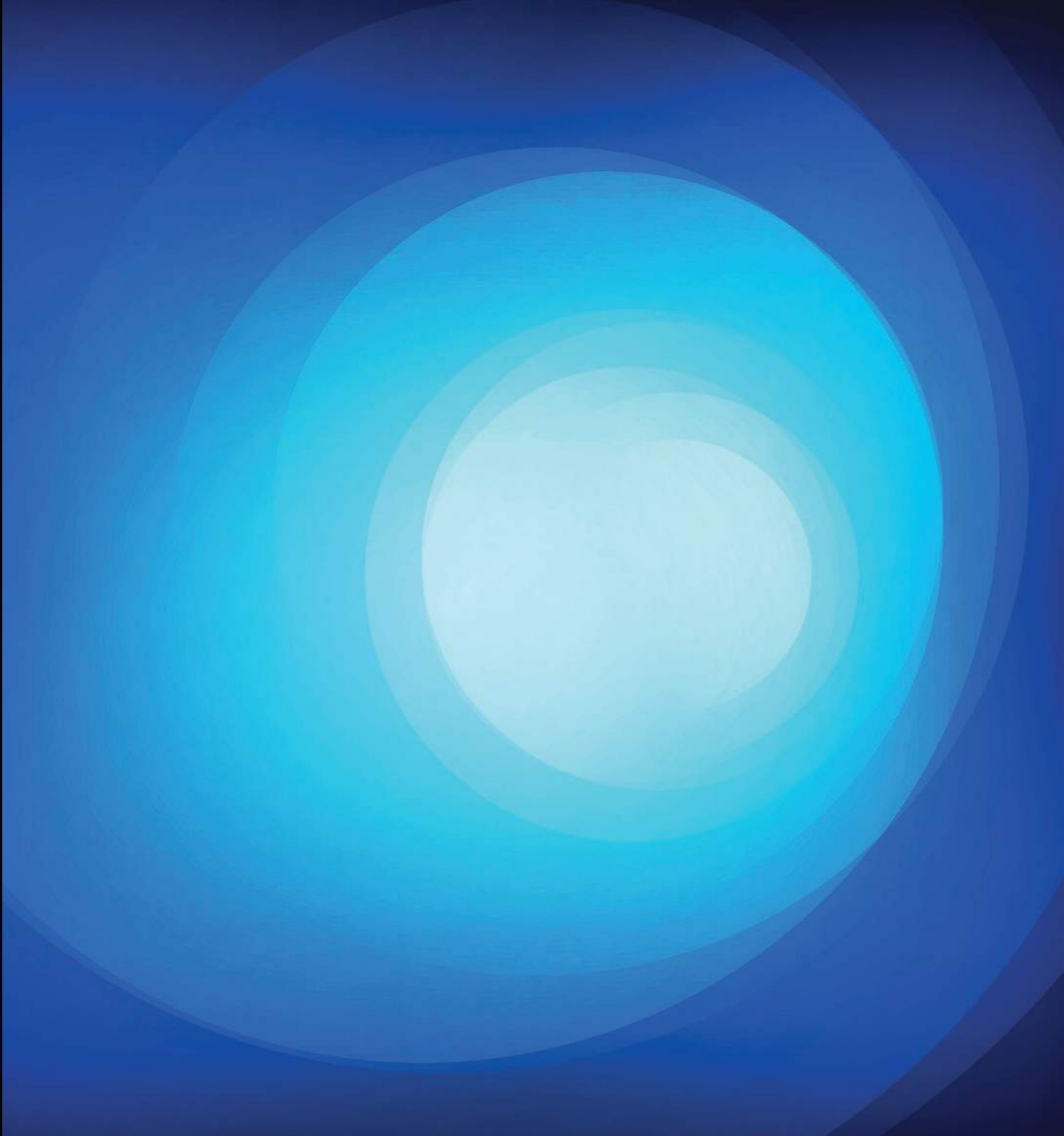

COLOUR CHANGING

La luce che cambia colore attribuisce ad un luogo un'identità dinamica declinabile in base alle necessità. Il colore della luce può cambiare per adeguarsi alle variazioni cromatiche stagionali, per promuovere eventi, per valorizzare un'architettura, per rendere più attrattivo uno spazio urbano o semplicemente per offrire al progettista l'opportunità di scegliere una precisa gradazione cromatica o tonale della luce.



• Colour changing RGBW 3000K: la tecnologia RGB+W utilizza chip led di colore rosso, verde, blu e bianco (4 chip led in 1) per creare una vasta gamma di opzioni di colore. Il chip bianco caldo (3000K) può essere miscelato con gli altri tre colori per creare colori precisi e vibranti o una luce bianca più luminosa e pura.



• Tunable White 2200K-4000K: La tecnologia di illuminazione Tunable White consente di controllare la temperatura colore della luce bianca. Si può regolare la luce da un colore bianco freddo, che è un po' bluastrò (4000K), fino a un colore bianco caldo, che è più giallastro (2200K). I sistemi ottici Tunable White possono essere controllati tramite DALI.

COLOUR CHANGING

The light that changes colour gives the space a dynamic identity that can be declined according to need. The colour of the light can change to adapt to seasonal chromatic variations, to promote events, to enhance an architecture, to make an urban space more attractive or simply to offer the designer the opportunity to choose a precise chromatic or tonal gradation of the light.



• Colour changing RGBW 3000K: RGB+W technology uses Red, Green, Blue and White LED chips (4 in 1 LED chips) to create a wide array of colours. The warm White chip (3000K) can be mixed with the other three colours to create more precise and vibrant colours or a brighter and more pure white light.



• Tunable White 2200K-4000K: Tunable white lighting technology means that you are able to control the white light's colour temperature. You can tune from a cool colour of white, which is a little bit bluish (4000K), down to a warm colour of white, which is more yellowish (2200K). Tunable White optical system can be controlled by DALI.

Servizi al cliente

Consulenza e continua assistenza

Non offriamo solo sistemi di illuminazione ma consulenza e continua assistenza al cliente dai primi sopralluoghi all'avviamento dell'impianto. Forniamo strumenti digitali per il progetto e mettiamo a disposizione la nostra lunga esperienza e la conoscenza di tutti gli aspetti normativi inerenti l'illuminazione di ambienti esterni. Al nostro interno è presente una divisione specializzata in progettazione illuminotecnica che è in grado di supportare i clienti attraverso la definizione del lighting concept, la realizzazione dei calcoli illuminotecnici e l'elaborazione di tavole di posizionamento, foto-inserimenti e rendering.

Customer services

Advice and continual support

We offer not only lighting systems, but advice and continual customer support from initial consultation to system start-up. We provide digital design tools and offer our long experience and knowledge of all regulatory aspects relating to outdoor lighting. We have a specialist lighting design division that can support customers throughout defining the lighting concept, making lighting calculations, processing positioning tables, photo-insertions and rendering.

Certifications



CTFS (CUSTOMERS' TESTING FACILITIES)

Riconoscimento rilasciato da IMQ al nostro laboratorio, che garantisce la conformità dei test e delle apparecchiature utilizzate alle norme europee ed internazionali vigenti.

CTFS (CUSTOMERS' TESTING FACILITIES)

Award issued by IMQ to our laboratory, guaranteeing that the tests and equipment we use comply with current European and international standards.



MARCATURA ENEC

Certifica che tutti i nostri prodotti osservino le norme di sicurezza vigenti in Europa, nonché la loro verifica periodica da parte di IMQ.

ENEC MARK

Certifying that all of our products comply with current European safety standards and are verified periodically by IMQ.

Ecovadis 2023



Un importante riconoscimento per il nostro impegno nella Responsabilità Sociale d'Impresa.

An important recognition for our commitment to Corporate Social Responsibility.

Sistemi ottici

L'essenza delle nostre soluzioni va ricercata nei sistemi ottici. La tecnologia LED ci ha permesso di differenziare la nostra offerta consentendoci oggi di rendere disponibili selezioni cromatiche e distribuzioni fotometriche in grado di soddisfare le richieste di ogni architettura, spazio e percorso urbano.

Optical systems

The essence of our solutions lies in the optics. LED technology has allowed us to supply something different. We make available colour selections and photometric distributions suitable for any urban route, architecture and space.

Architetture e Giardini

Le distribuzioni fotometriche per l'illuminazione di architetture e giardini si distinguono in ottiche:

- Spot fascio concentrante, medio, diffondente e ultra-diffondente;
- Elissoidali;
- Lama;
- Radenti 360° e 180°;
- Simmetriche, Asimmetriche, Rotosimmetriche;
- Wall washer.

Architectures and Gardens

The photometric distribution for lighting architecture and gardens include the following optics:

- Narrow, medium, wide and ultra-wide beam spotlights;
- Ellipsoidai;
- Blade;
- 360° e 180° surface skimming lights;
- Symmetrical, Asymmetrical, Rotosymmetrical;
- Wall washer.



Spazi e Percorsi urbani

Le distribuzioni fotometriche per l'illuminazione di spazi e percorsi urbani si distinguono in ottiche:

- Asimmetriche;
- Asimmetriche stradali;
- Simmetriche stradali;
- Rotosimmetriche;
- Diffondenti;
- Asimmetriche stradali per attraversamenti pedonali;
- Asimmetrica stradale per manto bagnato;
- Simmetrica stradale per centro strada;
- Front & Back.

L'ottica stradale Front & Back (brevettata) è in grado di generare un doppio solido fotometrico che assolve alla duplice funzione di illuminare da un lato la carreggiata e dal lato opposto una pista ciclabile o un'area pedonale.

Urban Spaces and Walkways

The photometric distribution for lighting urban spaces and pathways include the following optics:

- Asymmetrical;
- Street asymmetrical;
- Street symmetrical;
- Roto-symmetrical;
- Diffusing;
- Asymmetrical street for pedestrian crossings;
- Asymmetrical street for wet surfaces;
- Asymmetrical street for road centres;
- Front & Back.

The Front & Back optic (patented) can generate a double photometric solid that is able to light on one side the road and on the opposite side a cycle path or pedestrian area.

Sport e Grandi Aree

Le distribuzioni fotometriche per l'illuminazione di spazi sportivi e grandi aree si distinguono in ottiche:

- Asimmetriche;
- Asimmetriche stradali;
- Asimmetriche con retroilluminazione.

Sport and Large Areas

The photometric distribution for lighting of sport spaces and large areas include the following optics:

- Asymmetrical;
- Street asymmetrical;
- Asymmetrical with backlight.

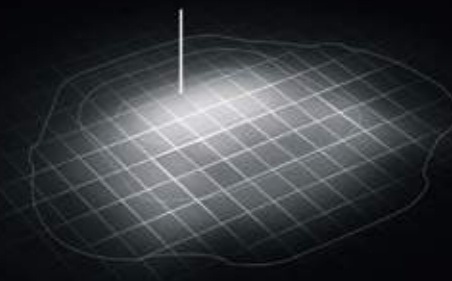
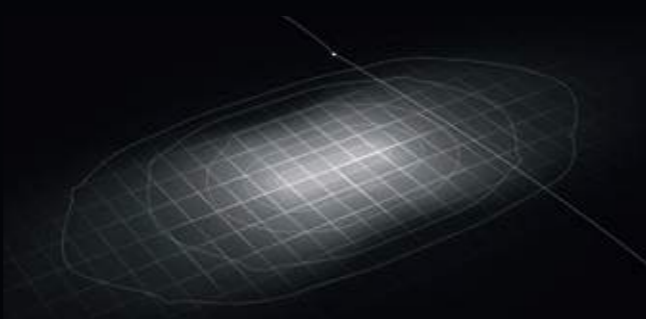
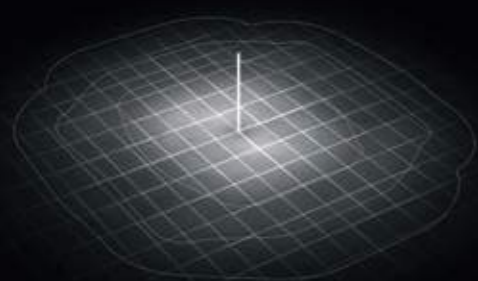

illuminazione intelligente

Smart lighting

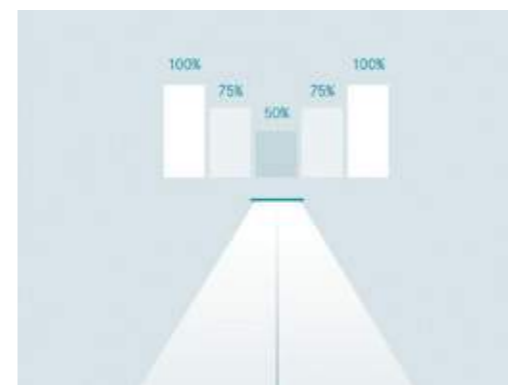

STAND ALONE: regolazione di flusso in Mezzanotte Virtuale

È una tecnica di riduzione del flusso luminoso stand-alone, completamente integrata in ogni singolo prodotto e che non richiede nuovi cablaggi o dispositivi esterni.

Autoapprendimento mezzanotte virtuale programmabile custom

Disponibili versioni programmabili custom su richiesta del cliente; mediante un algoritmo di mezzanotte virtuale è possibile eseguire una precisa riduzione percentuale del flusso luminoso dell'apparecchio e della potenza elettrica assorbita dall'apparecchio.

STAND ALONE: Virtual Midnight flow adjustment

This stand-alone light flow reduction system is built into every individual product and it does not require new wiring or external devices.

Custom programmable virtual midnight self-learning

Custom programmable versions are available at the customer's request. Using a virtual midnight algorithm, a precise reduction can be made in the luminaire's luminous flux percentage and its electrical power input.



ZHAGA - BOOK 18

I prodotti possono essere forniti con presa 4 pin (Zhaga Book 18) un'interfaccia intelligente tra apparecchi di illuminazione e sistemi di rilevamento e di comunicazione. Gli apparecchi di illuminazione equipaggiati di nodi di telecontrollo, creano una rete di comunicazione di tipo Wireless Sensor Network (WSN). Le informazioni transitano dagli apparecchi verso i gateway attraverso la rete, fino ad arrivare alla piattaforma software centrale. Al contrario, differenti scenari di Smart Lighting possono essere inviati dal software di controllo ai gateway, quindi ai nodi presso i punti luce.

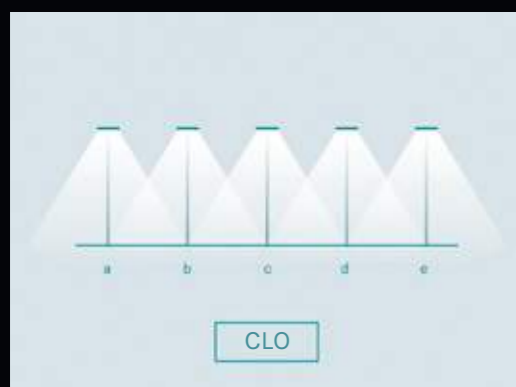

Constant Lumen Output (CLO)

I prodotti sono inoltre predisposti per il sistema di autoregolazione CLO (Constant Lumen Output). Il compito del CLO è quello di compensare il naturale decadimento del flusso luminoso dei LED. Attraverso un innalzamento di corrente graduale, precedentemente programmato, il flusso luminoso si mantiene nel tempo e comunque non diventa mai inferiore al valore limite preimpostato.

ZHAGA - BOOK 18

Our products can be supplied with a 4-pin socket (Zhaga Book 18), a smart interface between light fittings and measurement and communication systems. Light fixtures equipped with remote control nodes create a Wireless Sensor Network (WSN) type of communication. The information transits through the network to the gateways and then on to the central software platform. Conversely, the software can send different Smart Lighting scenes to control the gateways, and therefore the nodes at the light points.

Constant Lumen Output (CLO)

Our products are also CLO self-regulation system ready (Constant Lumen Output). The aim of CLO is to compensate the natural deterioration of the LED luminous flux. By pre-programming a gradual increase in current, the luminous flux is maintained over time and, in any case, never drops lower than the preset limit.



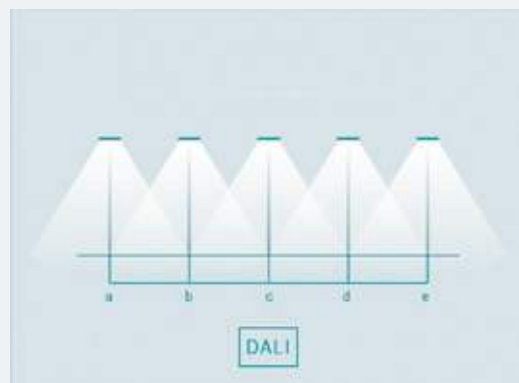

DALI

È un controllo di tipo digitale, dove ad ogni apparecchio viene assegnato un indirizzo univoco, che permette il controllo del singolo punto luce e la creazione di gruppi di controllo.

Onde convogliate (PLC)

Tramite la comunicazione a onde convogliate, quindi senza cavi aggiuntivi nell'impianto, è possibile comunicare con ogni singolo punto luce. Il sistema consente di monitorare da remoto ogni singolo apparecchio e di modificarne i profili di consumo.

Sensori

I prodotti con predisposizione ZHAGA sono compatibili con sensori luminosi che regolano l'emissione di luce in uscita sulla base della quantità di luce già presente nell'ambiente e con sensori di movimento che consentono di rilevare il passaggio di persone o veicoli e di regolare il flusso emesso per garantire i giusti livelli di sicurezza. I sensori devono essere montati esternamente al prodotto.

Wireless

Il sistema di telegestione wireless è in grado di gestire gli apparecchi da remoto in modo semplice e senza vincoli dovuti all'impianto preesistente. La tecnologia wireless consente di monitorare ogni singolo apparecchio e di modificarne i profili di consumo. Il sistema di telegestione wireless, oltre a contenere i consumi e le spese di gestione, predispone l'infrastruttura utile ad ospitare altri sistemi o servizi per il territorio compatibili con i più innovativi progetti di smart lighting.

DALI

This is a digital type control system where every device is assigned a unique address that allows the individual light points to be controlled and the control units to be created.

Power-line communication (PLC)

Using PLC communications, i.e. with no extra system wiring, it is possible to communicate with each individual light point. The system allows each individual luminaire to be monitored remotely and consumption profiles to be modified.

Sensors

Our products with arrangement for ZHAGA are compatible with light sensors that adjust the light emission output based on the quantity of light already in the space and with sensors allows the luminaire's luminous flux to be regulated and the correct safety levels maintained according to whether a person or a vehicle is passing. Sensors must be mounted outside the product.

Wireless

The wireless remote management system can remote control luminaires simply and without limits thanks to the existing system. Wireless technology allows each individual luminaire to be monitored remotely and consumption profiles to be modified. The wireless remote management system, as well reducing consumption and management costs, includes the infrastructure to host other systems or services for the territory, compatible with the latest smart lighting projects.



SPOON

SPOON è un nuovo sistema per l'illuminazione urbana, declinabile a diverse scale e coerente ai mutevoli scenari urbani contemporanei. Design by Alfonso Femia/AF*Design.

SPOON is a new urban lighting system that can be adapted to different scales and is consistent with the changing contemporary urban scenarios. Design by Alfonso Femia/AF*Design.

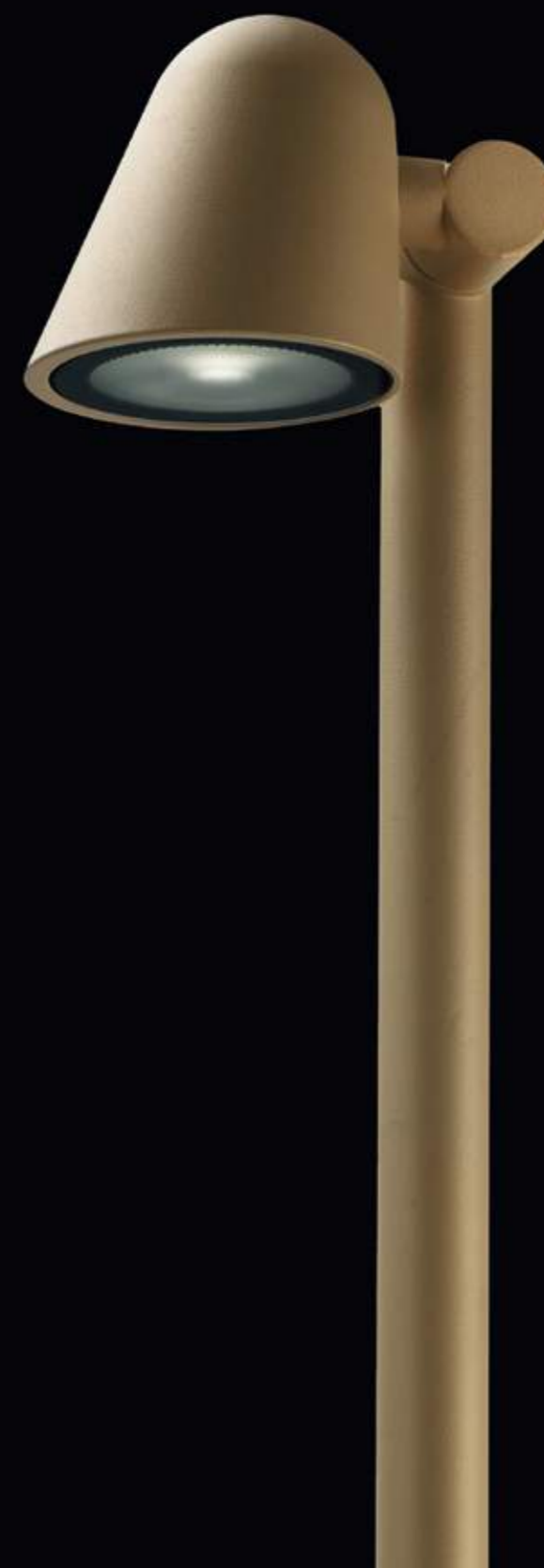



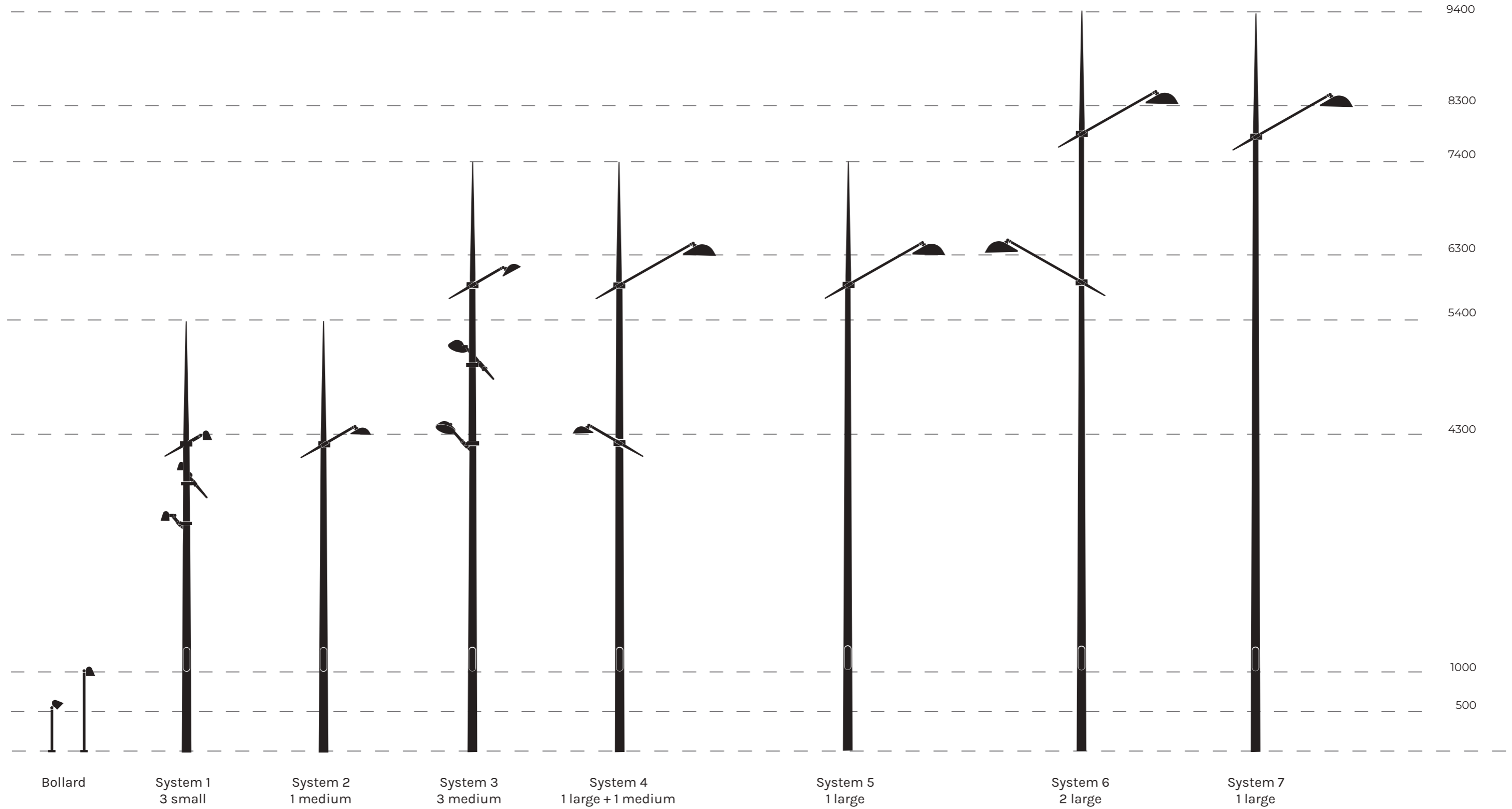

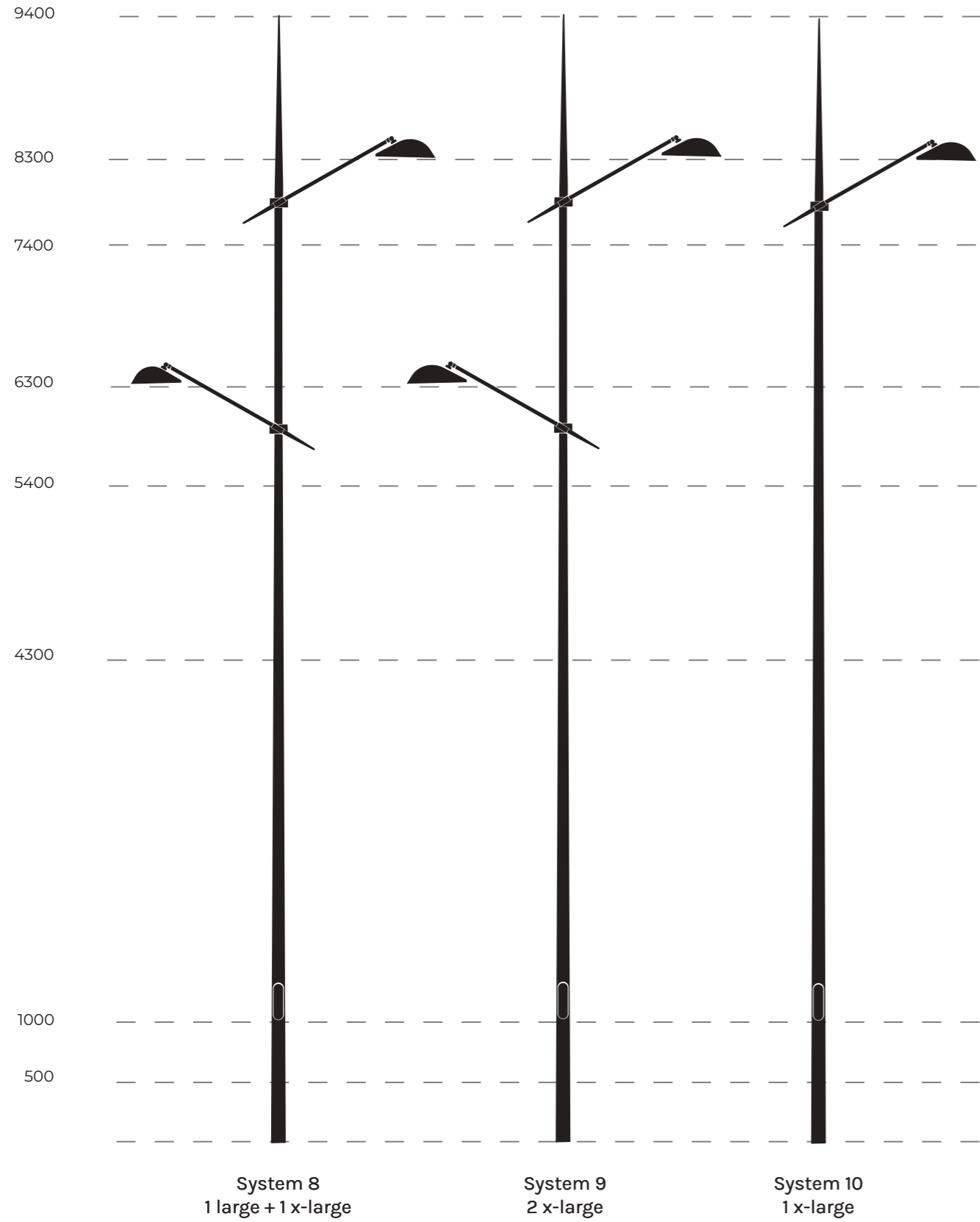

220-240V 24V (RGBW / TW)	50 60Hz	CL II	IP66	IK09	ta -30°C +50°C
-----------------------------	------------	-------	------	------	----------------------



DATI PRESTAZIONALI / PERFORMANCE DATA

Flusso apparecchio / Fitting flux:
770 - 17385 lm

Potenza apparecchio / Fitting power:
8 - 144 W

Indice di resa cromatica / Colour Rendering Index:
≥ 80, SDCM ≤ 3 (medium, large, x-large)
≥ 90, SDCM ≤ 3 (small)

Illuminazione intelligente / Smart lighting:
mezzanotte virtuale, DALI. Su richiesta ZHAGA UP (large, x-large) / virtual midnight, DALI. On request ZHAGA UP (large, x-large)

MATERIALI / MATERIALS

Corpo, sistemi di fissaggio e puntali / Body, fitting systems and rods:
pressofusione di lega d'alluminio UNI EN AB 47100 (contenuto rame < 1%) / die-cast aluminium alloy UNI EN AB 47100 (copper content < 1%)

Schermo / Screen:
vetro piano temprato / tempered flat glass

Gruppo ottico / Optical unit:
lente in tecnopolimero ad alta trasparenza (small), lenti in PMMA ad alta trasparenza (medium, large, x-large) / highly transparent technopolymer lens (small), PMMA high transparent lenses (medium, large, x-large)

Finitura / Finish:
fosfocromatazione e verniciatura in polveri di poliestere realizzata in 16 fasi per la miglior resistenza agli agenti atmosferici / phospho-chromatation treated and polyester powder-coated in 16 phases to increase weather resistance

TEMPERATURA COLORE COLOUR TEMPERATURE



ECO-CENTRIC LIGHTING (ECL)

(ONLY FOR STREET OPTICS, LARGE AND X-LARGE VERSIONS)

BLUE FREE LIGHT:

PC-AMBER 0,7% ΣR ($\lambda < 500\text{NM}$) – CRI 40
1800 K 4,3% ΣR ($\lambda < 500\text{NM}$) – CRI 70

SWITCHABLE WHITE LIGHT:

1800K / 3000K

COLORI / COLOURS



CARATTERISTICHE / FEATURES

Peso massimo / Max weight:

6 kg (bollard); 4.5 kg (small); 7 kg (medium); 9 kg (large);
10 kg (x-large)

Alimentazione elettronica / Electronic power supply:
inclusa / included

Precablaggio / Pre-wiring:
prodotto precablato con cavo e connettore / pre-wired product with cable and connector

Resistenza sovratensioni / Surge Protection Device:
10kV MC/MD (medium, large, x-large)

Installazione / Installation:
terra, palo, parete, sottoportico
ground, pole, wall, arcade



OTTICHE / OPTICS

C 10° Narrow Beam

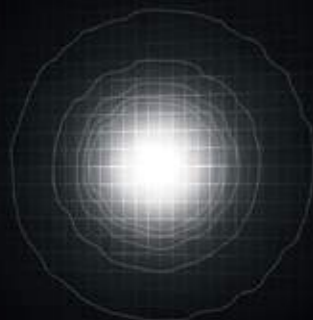

D 45° Wide Beam

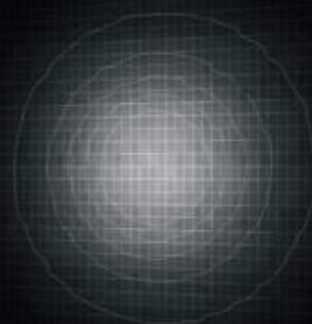

M 25° Medium Beam



U-D 90° Diffused Beam



AS-D Asymmetric Diffused Beam



Spoon
Bollard

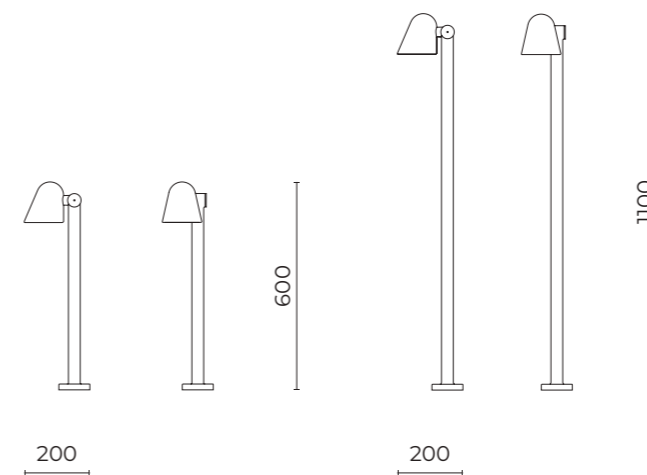

BOLLARD
1000



BOLLARD
500



DATI TECNICI / TECHNICAL DATA

Installazione / Installation:
terra / ground

Inclinazione / Inclination:
0° ÷ 180°, rotazione ±30°
0° ÷ 180°, rotation ±30°

ACCESSORI / ACCESSORIES

06PY999X0
Kit tirafondi
Anchoring bolts kit 30

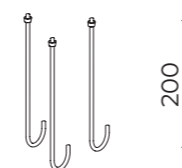

Spoon System

DATI TECNICI / TECHNICAL DATA

Installazione / Installation:
palo conico con puntale / conical pole with rod

Inclinazione / Inclination:
+120° ÷ -60° (small)
0° ÷ +90° (medium, large, x-large)

SMALL

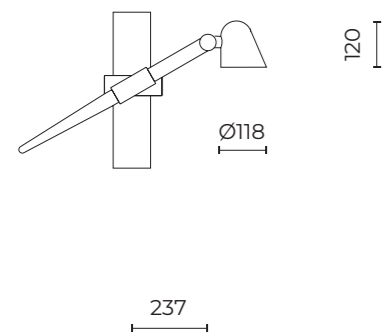

MEDIUM

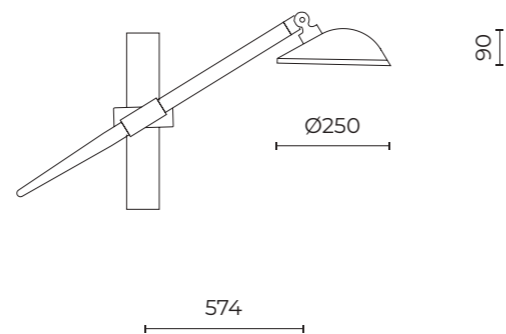

LARGE

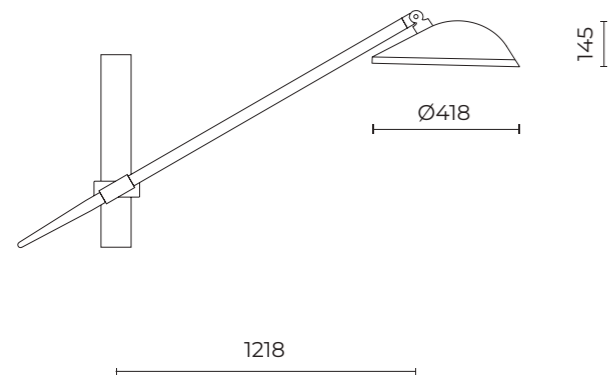

XLARGE

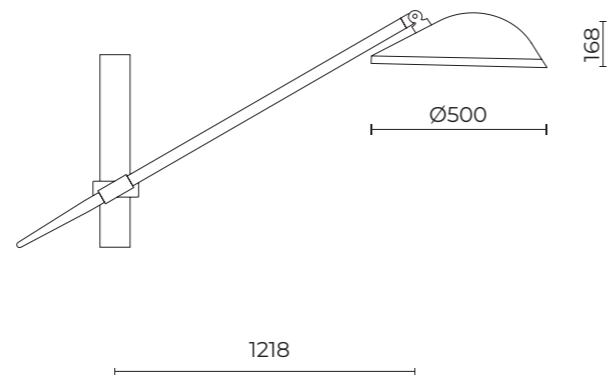

CONFIGURAZIONI / CONFIGURATIONS:

Spoon System 1

Palo con puntale h. tot. 5400 mm,
3 Spoon Small
Pole with rod h. tot. 5400 mm,
3 Spoon Small

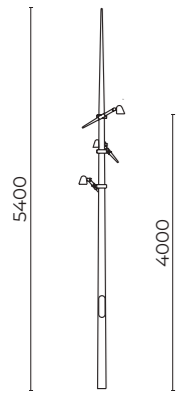

329

Spoon System 2

Palo con puntale h. tot. 5400 mm,
1 Spoon Medium
Pole with rod h. tot. 5400 mm,
1 Spoon Medium

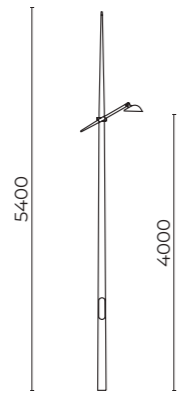

574

Spoon System 3

Palo con puntale h. tot. 7400 mm,
3 Spoon Medium
Pole with rod h. tot. 7400 mm,
3 Spoon Medium

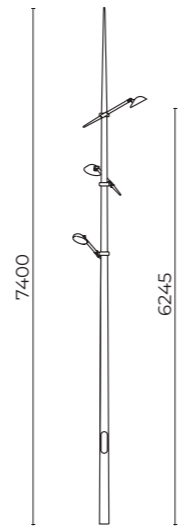

574

Spoon System 4

Palo con puntale h. tot. 7400 mm,
1 Spoon Medium, 1 Spoon Large
Pole with rod h. tot. 7400 mm,
1 Spoon Medium, 1 Spoon Large

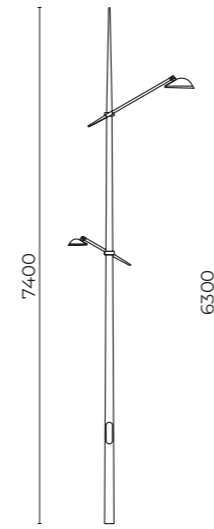

574 1218

Spoon System 5

Palo con puntale h. tot. 7400 mm,
1 Spoon Large
Pole with rod h. tot. 7400 mm,
1 Spoon Large

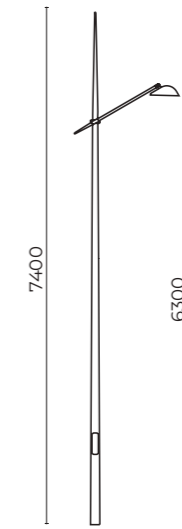

1218

Spoon System 6

Palo con puntale h. tot. 9400 mm,
2 Spoon Large
Pole with rod h. tot. 9400 mm,
2 Spoon Large

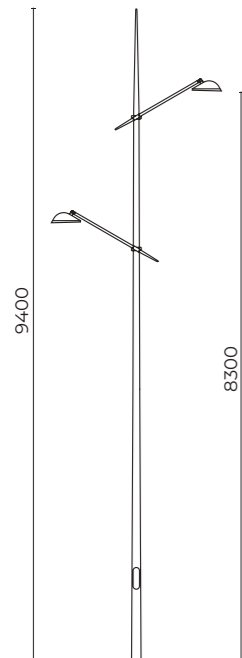

574 1218

Spoon System 7

Palo con puntale h. tot. 9400 mm,
1 Spoon Large
Pole with rod h. tot. 9400 mm,
1 Spoon Large

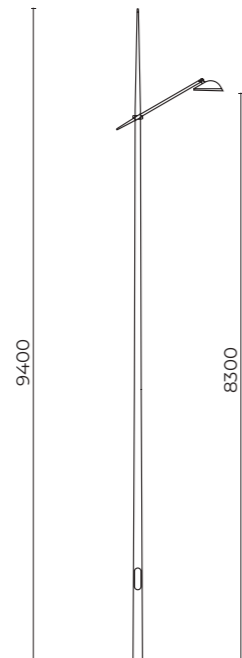

1218

Spoon System 8

Palo con puntale h. tot. 9400 mm,
1 Spoon Large, 1 Spoon X-Large
Pole with rod h. tot. 9400 mm,
1 Spoon Large, 1 Spoon X-Large

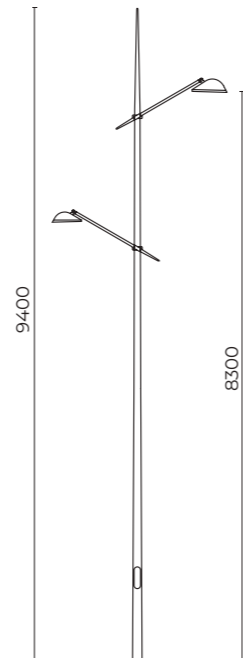

574 1218

Spoon System 9

Palo con puntale h. tot. 9400 mm,
2 Spoon X-Large
Pole with rod h. tot. 9400 mm,
2 Spoon X-Large

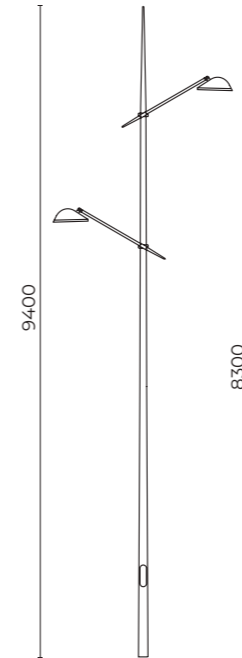

574 1218

Spoon System 10

Palo con puntale h. tot. 9400 mm,
1 Spoon X-Large
Pole with rod h. tot. 9400 mm,
1 Spoon X-Large

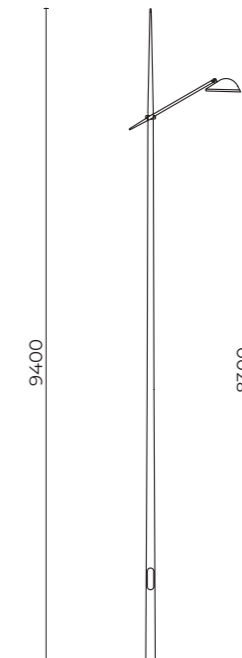

1218

Spoon

OTTICHE / OPTICS

C 10° Narrow Beam



M 25° Medium Beam

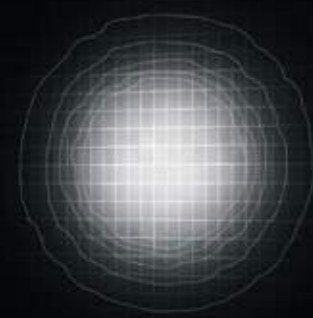

D 45° Wide Beam

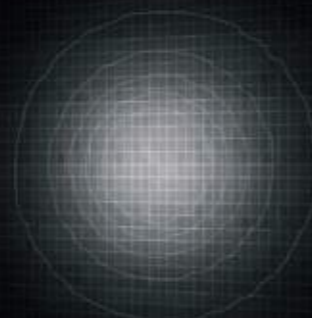

U-D 90° Diffused Beam



SPOON SMALL

Spoon System



OTTICHE / OPTICS

SPOON MEDIUM / LARGE / X-LARGE

C 11° Narrow Beam



D 40° Wide Beam

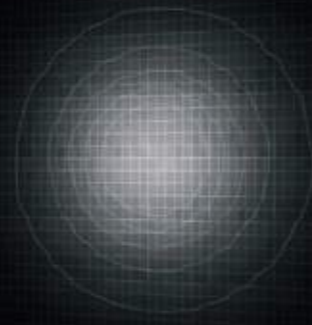

M 25° Medium Beam

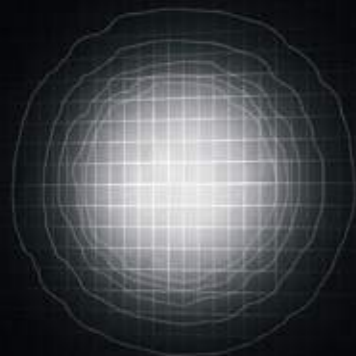

U-D 90° Diffused Beam

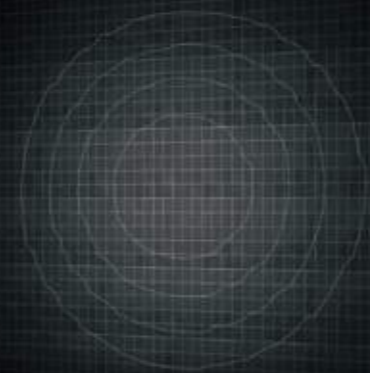

LT-C1 Cycle Path
L / H = 0,5

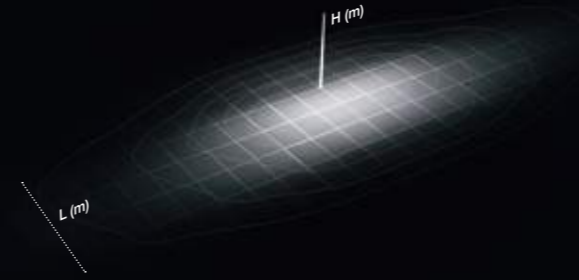

ST-02 Narrow Street
L / H = 0,75

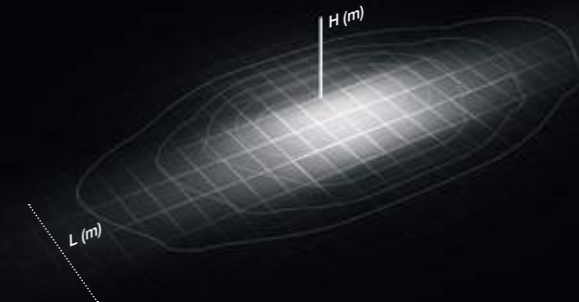

ME-06 Medium Street with sidewalk
L / H = 1

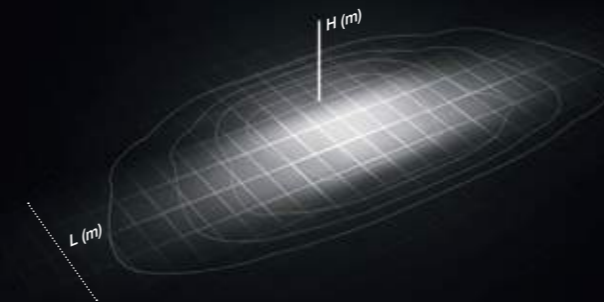

LA-03 Wide Street
L / H = 1,25

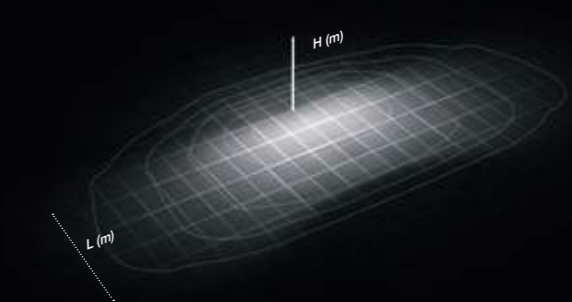

PB-01 Low Pole
L / H = 2

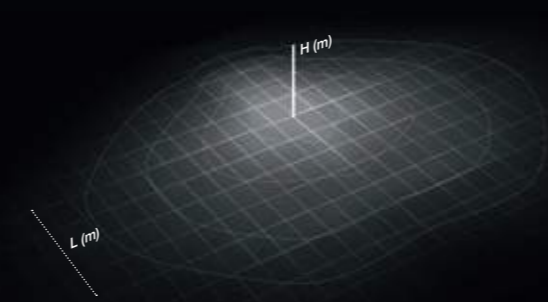

LT-64 Asymmetric Beam with backlight
L / H = 2



* only for Spoon Wall

C 10° Narrow Beam *

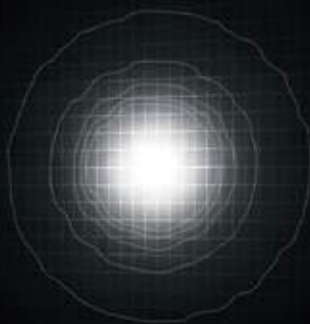

D 45° Wide Beam *

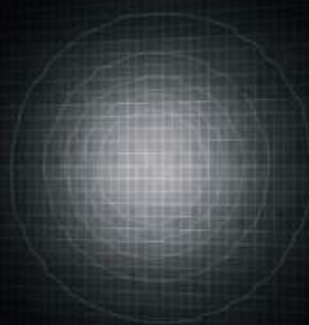

M 25° Medium Beam *



U-D 90° Diffused Beam *



AS-D Asymmetric Diffused Beam



Spoon Wall, Overdoor

DATI TECNICI / TECHNICAL DATA

Installazione / Installation:
parete, sopraporta / wall, overdoor

Inclinazione / Inclination:
-120° + 30° (Spoon Wall)
0° + 90° (Spoon Overdoor)

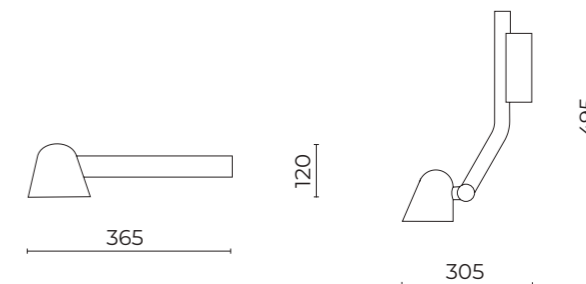

C 11° Narrow Beam

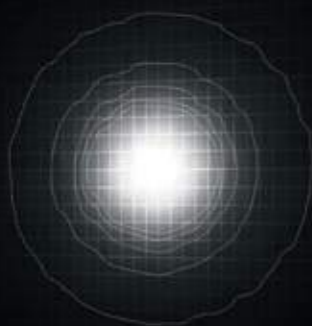

D 40° Wide Beam

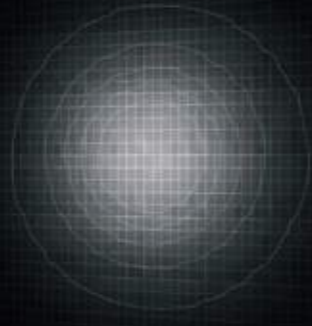

ST-02 Narrow Street
L / H = 0,75

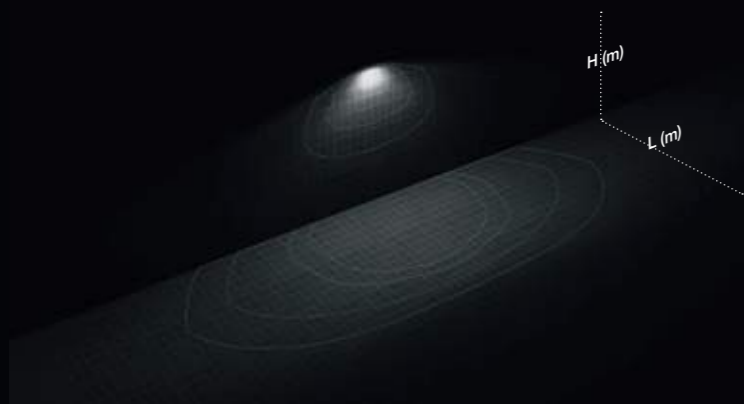

LT-63 Assymetric Beam
L / H = 2

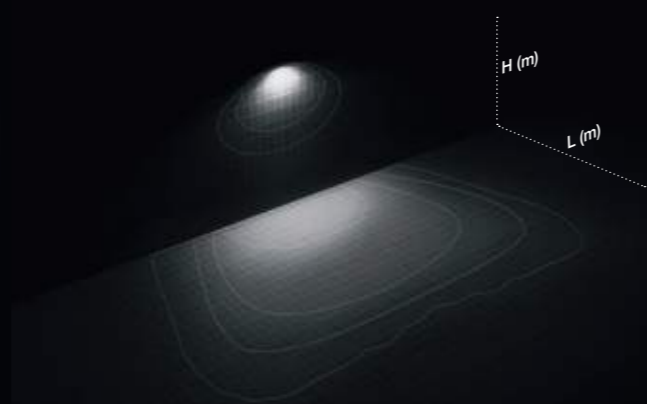

Spoon
Wall

DATI TECNICI / TECHNICAL DATA

Installazione / Installation:
parete / wall

Inclinazione / Inclination:
0° ÷ 90°



MEDIUM

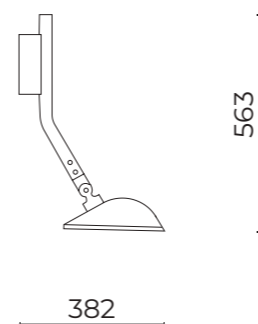

LARGE

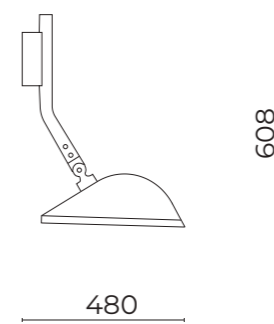

X-LARGE

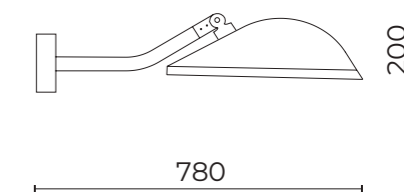
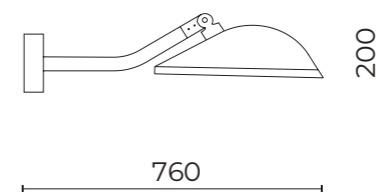
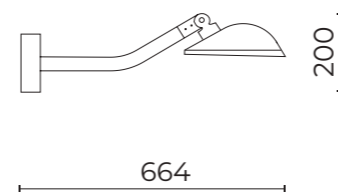
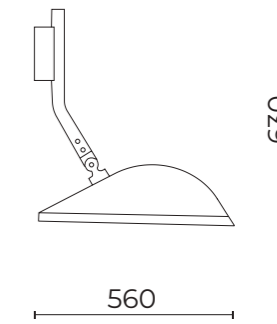

Spoon

OTTICHE / OPTICS

C 11° Narrow Beam

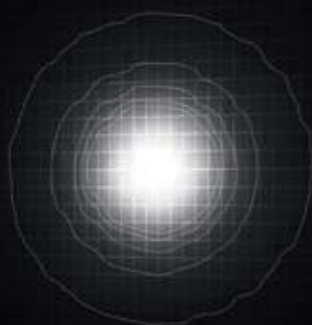

D 40° Wide Beam

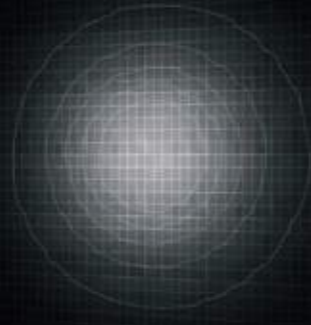

M 25° Medium Beam

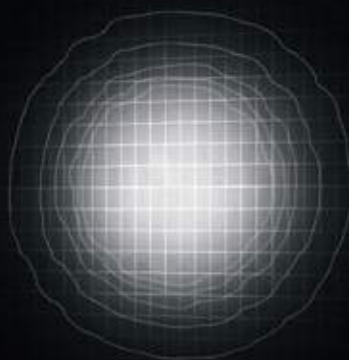

U-D 90° Diffused Beam

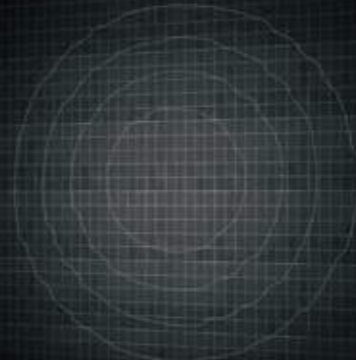

Spoon Ceiling

DATI TECNICI / TECHNICAL DATA

Installazione / Installation:
soffitto / ceiling

Inclinazione / Inclination:
0° ÷ 90°



MEDIUM

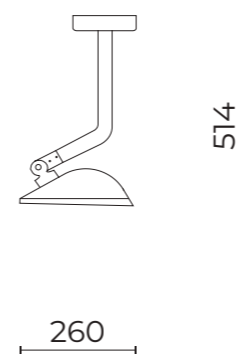

LARGE

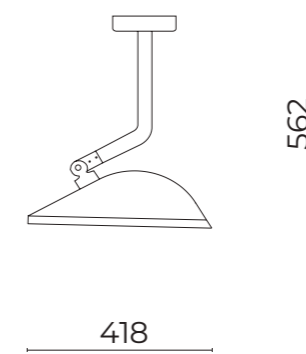

X-LARGE

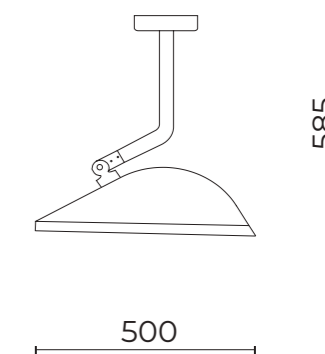

KONO ZOOM

KONO ZOOM è un proiettore che si distingue per una sofisticata tecnologia ottica e una raffinata ricerca estetica. È ideale per l'illuminazione d'accento e diffusa di spazi esterni d'interesse artistico e architettonico.

KONO ZOOM is a floodlight characterised by sophisticated optical technology and refined aesthetic research. It is ideal for accent and diffused lighting of outdoor spaces of artistic and architectural interest.





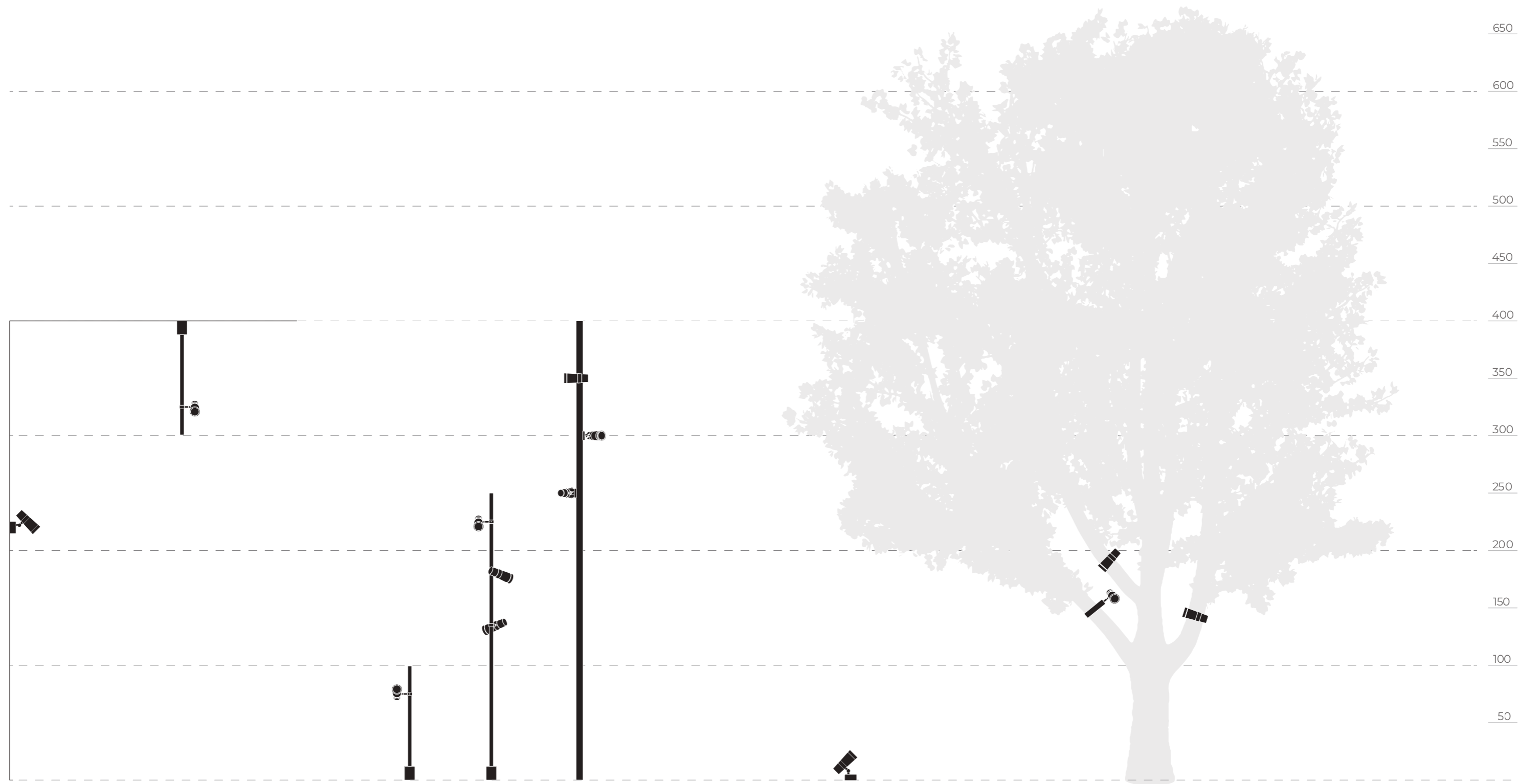

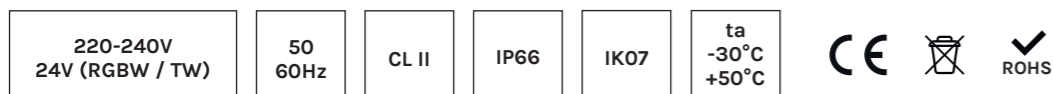

DATI PRESTAZIONALI / PERFORMANCE DATA

Flusso apparecchio / Fitting flux:
72 - 474 lm

Potenza apparecchio / Fitting power:
10W

Indice di resa cromatica / Colour Rendering Index:
CRI ≥ 90, SMCD ≤ 2 (2700 K)
CRI ≥ 80, SMCD ≤ 3

Illuminazione intelligente / Smart lighting:
DALI

TEMPERATURA COLORE COLOUR TEMPERATURE

-  2700 K
-  3000 K
-  4000 K
-  RGB+W 3000 K
-  TUNABLE WHITE 2200 K + 4000 K

MATERIALI / MATERIALS

Corpo e sistemi di fissaggio / Body and fitting system:
pressofusione di lega d'alluminio UNI EN AB 47100
(contenuto rame < 1%) / die-cast aluminum alloy UNI EN
AB 47100 (copper content < 1%)

Schermo / Screen:
vetro piano temprato
tempered flat glass

Gruppo ottico / Optical unit:
lente in vetro stampato
moulded glass lens

Finitura / Finish:
fosfocromatazione e verniciatura in polveri di poliestere
realizzata in 16 fasi per la miglior resistenza agli
agenti atmosferici / phospho-chromatation treated
and polyester powder-coated in 16 phases to increase
weather resistance

COLORI / COLOURS

-  SABLE' 100 NOIR (*) / CHAMPAGNE (**)

* **Corpo e sistema di fissaggio** / Body and fitting system

** **Snodo e anello** / Joint and ring

CARATTERISTICHE / FEATURES

Peso massimo / Max weight:
1.6 kg (Flood/Pole), 4.7 kg (Bollard H 1000 mm),
9.2 kg (Bollard H 2500 mm)

Alimentazione elettronica / Electronic power supply:
inclusa (versione Flood ON-OFF, DALI), esclusa (versione
Flood RGBW, TW e versioni Ceiling/Bollard/Pole ON-OFF,
DALI, RGBW, TW)
internal (Flood version ON-OFF, DALI), external (Flood
version RGBW, TW and Ceiling/Bollard/Pole versions ON-
OFF, DALI, RGBW, TW)

Precablaggio / pre-wiring:
versioni con sostegni fornite con cavo e connettore
versions with rod supplied with cable and connector

Installazione / Installation:
parete, soffitto, terra / wall, ceiling, ground



OTTICHE / OPTICS

Round zoom

Min. 10°

Max. 45°



Kono zoom
Flood

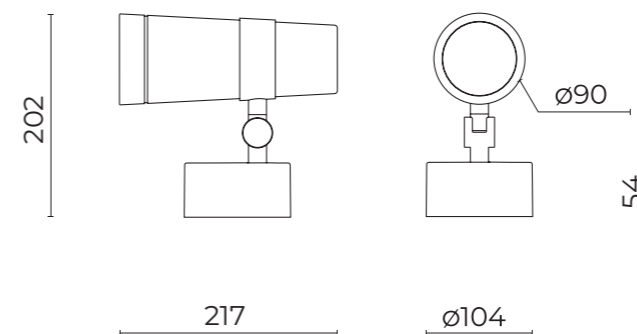

DATI TECNICI / TECHNICAL DATA

Installazione / Installation:
parete, terra / wall, ground

Inclinazione / Inclination:
-60° ÷ +90°; rotazione + 359°
-60° ÷ +90°; rotation + 359°

Ottiche Zoom / Zoom optics:
possibilità di regolazione del fascio luminoso dall'esterno, ruotando la ghiera posteriore, con il prodotto installato e acceso per l'ottimizzazione del puntamento / the light beam can be adjusted from outside, by turning the rear ring, while product is installed and switched on for pointing optimisation.

ACCESSORI / ACCESSORIES

060M901C0
B135 - Picchetto per interrimento
Picket for ground installation

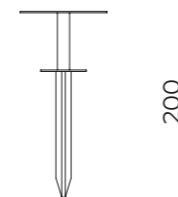

06KN901C0
B233 Cinghia di ancoraggio per alberi
Ø150-600 mm / Tree lashing strap
Ø150-600 mm

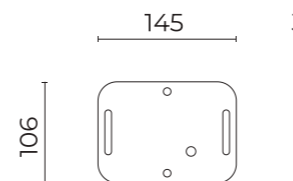



Kono zoom Ceiling

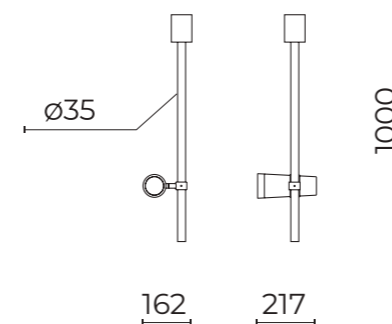

DATI TECNICI / TECHNICAL DATA

Installazione / Installation:
parete, soffitto / wall, ceiling

Inclinazione / Inclination:
+/- 359°; rotazione +/- 15°
+/- 359°; rotation +/- 15°

Ottiche Zoom / Zoom optics:
possibilità di regolazione del fascio luminoso dall'esterno, ruotando la ghiera posteriore, con il prodotto installato e acceso per l'ottimizzazione del puntamento / the light beam can be adjusted from outside, by turning the rear ring, while product is installed and switched on for pointing optimisation.



OTTICHE / OPTICS

Round zoom

Min. 10°

Max. 45°



Kono zoom
Bollard

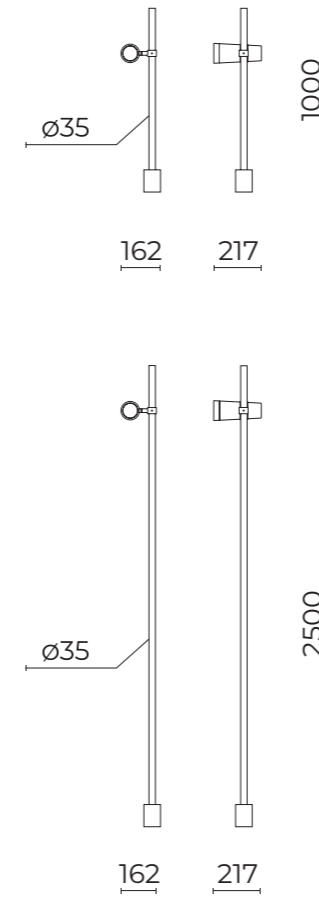

DATI TECNICI / TECHNICAL DATA

Installazione / Installation:
terra / ground

Inclinazione / Inclination:
+/- 359°; rotazione +/- 15°
+/- 359°; rotation +/- 15°

Ottiche Zoom / Zoom optics:
possibilità di regolazione del fascio luminoso dall'esterno, ruotando la ghiera posteriore, con il prodotto installato e acceso per l'ottimizzazione del puntamento / the light beam can be adjusted from outside, by turning the rear ring, while product is installed and switched on for pointing optimisation.





Kono zoom

Pole

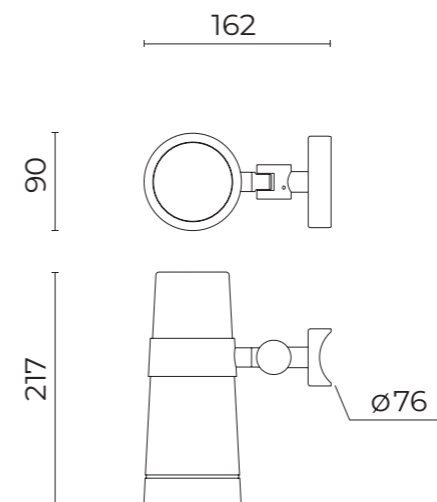

DATI TECNICI / TECHNICAL DATA

Installazione / Installation:
terra / ground

Inclinazione / Inclination:
-60° ÷ +90°; rotazione + 359°
-60° ÷ +90°; rotation + 359°

ACCESSORI / ACCESSORIES

06KN905CO

**Palo H = 4000 mm Ø 76 mm per installazione di
max N. 3 Kono / Pole H = 4000 mm Ø 76 mm for
the installation of maximum N. 3 Kono**



BAMBOO & BAMBOO MINI

Paletti con distribuzione luminosa radente,
simmetrica o asimmetrica, ideale per
l'illuminazione di aree verdi e camminamenti.

Small poles with symmetrical or asymmetrical
grazing light distribution, ideal for lighting
green areas and paths.





220 240V	50 60Hz	CL II	IP66 *	IP65 **	IK10 *	IK09 **	ta -30°C +50°C	CE		ROHS
-------------	------------	-------	--------	---------	--------	---------	----------------------	----	--	------

* Bamboo
** Bamboo mini

DATI PRESTAZIONALI / PERFORMANCE DATA

Flusso apparecchio / Fitting flux:
425 - 1000 lm

Potenza apparecchio / Fitting power:
7,6 - 12 W

Indice di resa cromatica / Colour Rendering Index:
CRI ≥ 80, SDCM ≤ 3

Illuminazione intelligente / Smart lighting:
DALI

**TEMPERATURA COLORE
COLOUR TEMPERATURE**

- 2700 K
- 3000 K
- 4000 K

COLORI / COLOURS

- SABLÉ 100 NOIR
- RAL9006

MATERIALI / MATERIALS

Corpo, collimatore e flangia di base

Body, collimator and fixing base:
pressofusione di lega d'alluminio UNI EN AB 47100
(contenuto rame < 1%) / die-cast aluminum alloy UNI
EN AB 47100 (copper content < 1%)

Fusto / Steam pole:
alluminio estruso
extruded aluminium alloy

Gruppo ottico / Optical unit:
policarbonato opale diffondente
wide opal polycarbonate

Finitura / Finish:
fosfocromatazione e verniciatura in polveri di
poliestere realizzata in 16 fasi per la miglior resistenza
agli agenti atmosferici / phospho-chromatation treated
and polyester powder-coated in 16 phases to increase
weather resistance

CARATTERISTICHE / FEATURES

Peso massimo / Max weight:

Bamboo:
1,6 kg (grazer), 3 kg (H 400 mm), 4,6 kg (H 900 mm)
Bamboo mini:
0,8 kg (grazer), 1,6 kg (H 375 mm), 2,5 kg (H 895 mm)

Alimentazione elettronica / Electronic power supply:
inclusa, esclusa solo nella versione Bamboo mini Grazer
- Wall DALI / internal, external only in Bamboo mini Grazer -
Wall DALI version

Precablaggio / pre-wiring:
versione bollard fornita con cavo e connettore;
predisposizione entra-esci
bollard version is supplied with cable and connector;
in and out setup

Installazione / Installation:
terra, parete / ground, wall

Fissaggio / Fixing system:
con tirafondi (fornibili) o tasselli / with metal anchors
(available) or plugs



OTTICHE / OPTICS

RS-D 360° Rotosymmetric Diffused Beam

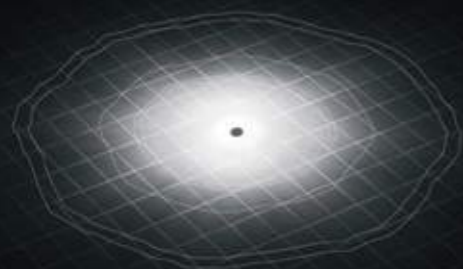

AD 180° Asymmetric Diffused Beam (only Bamboo)



Bamboo & Bamboo mini
Bollard

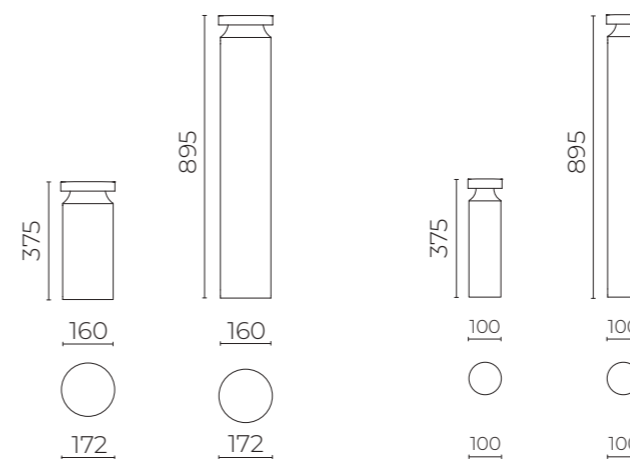

ACCESSORI / ACCESSORIES

06PY999X0
Kit tirafondi
Anchoring bolts kit 30

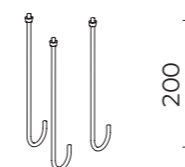

OTTICHE / OPTICS

PARETE / WALL

RS-D 360° Rotosymmetric Diffused Beam

AD 180° Asymmetric Diffused Beam (only Bamboo)

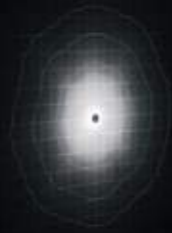

GRAZER

RS-D 360° Rotosymmetric Diffused Beam

AD 180° Asymmetric Diffused Beam (only Bamboo)

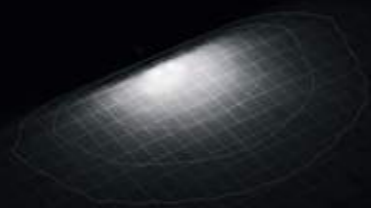
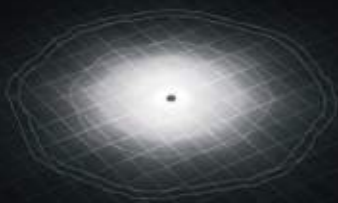

Bamboo & Bamboo mini
Wall

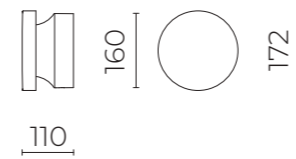

Grazer

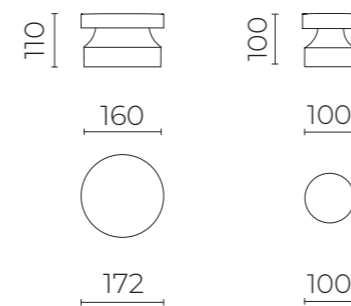

ACCESSORI / ACCESSORIES

06BM902X0
Kit driver DALI per Bamboo mini / Kit
DALI driver for Bamboo mini

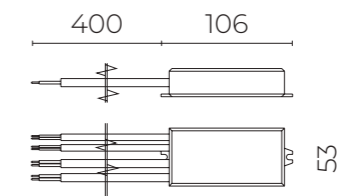

IOTA

Paletti con distribuzione luminosa simmetrica o asimmetrica, ideale per l'illuminazione aree verdi e camminamenti.

Bollard with symmetrical or asymmetrical light distribution, ideal for lighting green areas and paths.





DATI PRESTAZIONALI / PERFORMANCE DATA

Flusso apparecchio / Fitting flux:
425 - 1000 lm

Potenza apparecchio / Fitting power:
9,5 - 12 W

Indice di resa cromatica / Colour Rendering Index:
CRI ≥ 80, SDCM ≤ 3

Illuminazione intelligente / Smart lighting:
DALI

MATERIALI / MATERIALS

Corpo, collimatore e flangia di base



Body, collimator and fixing base:
pressofusione di lega d'alluminio UNI EN AB 47100
(contenuto rame < 1%) / die-cast aluminum alloy UNI
EN AB 47100 (copper content < 1%)

Fusto / Steam pole:
alluminio estruso
extruded aluminium alloy

Gruppo ottico / Optical unit:
policarbonato opale diffondente
wide opal polycarbonate

Finitura / Finish:
fosfocromatazione e verniciatura in polveri di
poliestere realizzata in 16 fasi per la miglior resistenza
agli agenti atmosferici / phospho-chromatation treated
and polyester powder-coated in 16 phases to increase
weather resistance

TEMPERATURA COLORE COLOUR TEMPERATURE

-  2700 K
-  3000 K
-  4000 K

COLORI / COLOURS

-  SABLÉ 100 NOIR
-  RAL9006

CARATTERISTICHE / FEATURES

Peso massimo / Max weight:
3,5 kg (375 mm), 6 kg (895 mm)

Alimentazione elettronica / Electronic power supply:
inclusa / included

Precablaggio / Pre-wiring:
versione bollard fornita con cavo e connettore;
predisposizione entra-esci
bollard version is supplied with cable and connector;
in and out setup

Installazione / Installation:
terra / ground

Fissaggio / Fixing system:
con tirafondi (fornibili) o tasselli / with metal anchors
(available) or plug



OTTICHE / OPTICS

RS-D 360° Rotosymmetric Diffused Beam

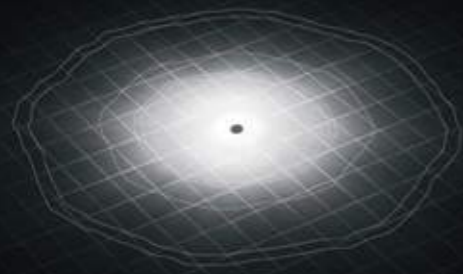

AD 180° Asymmetric Diffused Beam



Iota
Bollard

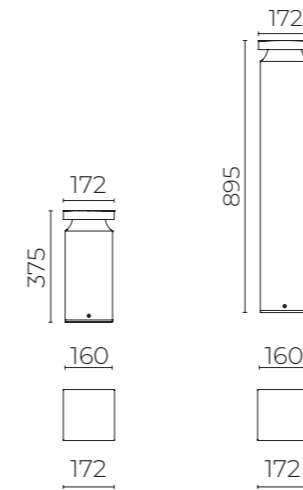

ACCESSORI / ACCESSORIES

06PY999X0
Kit tirafondi
Anchoring bolts kit

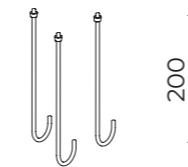

LIT XS

Applique monoemissione e bollard dalla forma compatta ed essenziale, ideale per l'illuminazione di portici, passaggi pedonali, aree esterne agli edifici e aree verdi, sia in contesti pubblici che privati.

Wall-mounted mono-emission product and bollard with a compact, clean shape, ideal for lighting arcades, pedestrian pathways, areas outside offices and green areas.





220 240V	50 60Hz	CL II	IP66	IK08	ta -30°C +50°C
-------------	------------	-------	------	------	----------------------



DATI PRESTAZIONALI / PERFORMANCE DATA

Flusso apparecchio / Fitting flux:
500 - 550 lm (applique), 460 - 500 lm (bollard)

Potenza apparecchio / Fitting power:
10,5 W (applique), 8 W (bollard)

Indice di resa cromatica / Colour Rendering Index:
CRI ≥ 80, SDCM ≤ 3

Illuminazione intelligente / Smart lighting:
DALI su richiesta / DALI on request

MATERIALI / MATERIALS

Corpo / Body:
pressofusione di lega d'alluminio UNI EN AB 47100
(contenuto rame < 1%) / die-cast aluminium alloy UNI EN
AB 47100 (copper content < 1%)

Palo / Pole:
alluminio estruso
extruded aluminium

Schermo / Screen:
vetro comfort / glass comfort

Gruppo ottico / Optical unit:
lenti PMMA ad alta trasparenza (bollard)
high-transparency PMMA lenses (bollard)

Finitura / Finish:
fosfocromatazione e verniciatura in polveri di poliestere
realizzata in 16 fasi per la miglior resistenza agli
agenti atmosferici / phospho-chromatation treated
and polyester powder-coated in 16 phases to increase
weather resistance

TEMPERATURA COLORE COLOUR TEMPERATURE

- 2700 K
- 3000 K
- 4000 K

COLORI / COLOURS

- SABLÉ 100 NOIR

CARATTERISTICHE / FEATURES

Peso massimo / Max weight:
2 kg (applique), 4 kg (bollard H 500),
6 kg (bollard H 1000)

Alimentazione elettronica / Electronic power supply:
versione ON-OFF inclusa, versione DALI esclusa
ON-OFF version included, DALI version external

Precablaggio / Pre-wiring:
versione bollard fornita con cavo e connettore
bollard version is supplied with cable and connector

Installazione / Installation:
parete, terra / wall, ground



WALL

BOLLARD
1000BOLLARD
500

OTTICHE / OPTICS

AS-D Asymmetric Diffused Beam

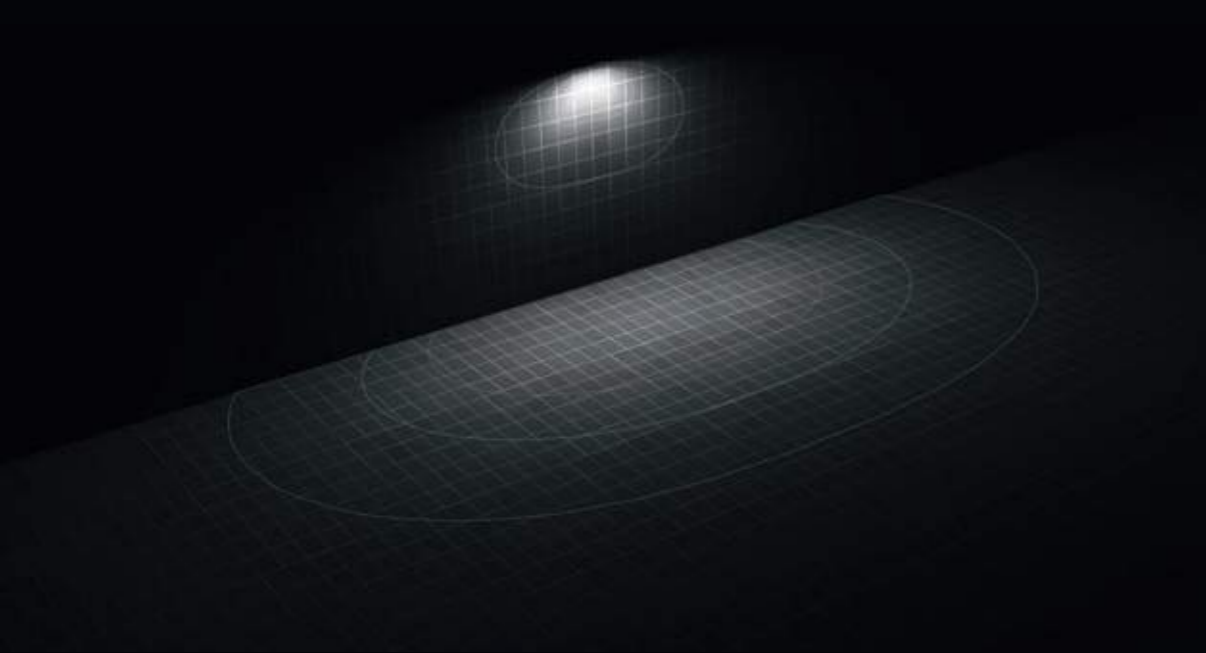

Lit xs
Wall

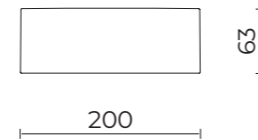
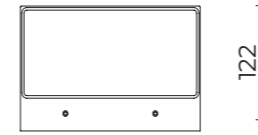

ACCESSORI / ACCESSORIES

06LL914AB0
Driver elettronico DALI 150W 24V IP67
DALI electronic driver 150W 24V IP67

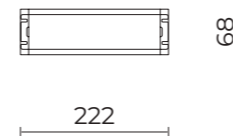

06LX900X0
D1 - Driver DALI 20W 24V IP20
DALI driver 20W 24V IP20

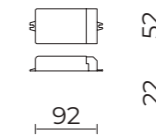

OTTICHE / OPTICS

AS-D Asymmetric Diffused Beam



Lit xs
Bollard

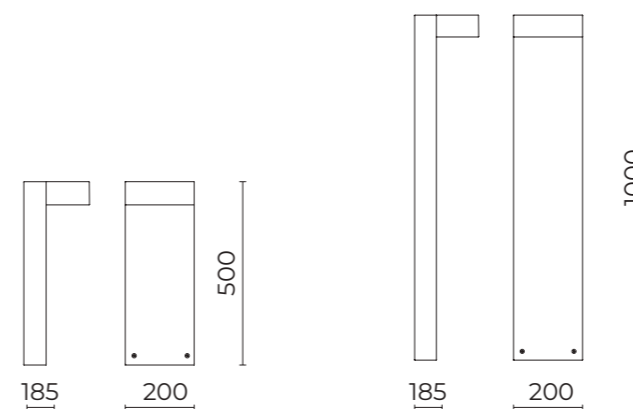

ACCESSORI / ACCESSORIES

06KS909C0
B89 - Connettore 4 vie IP68
4-way connector IP68

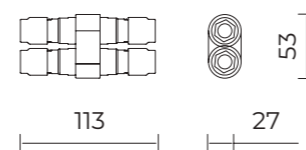

06LT931J0
Kit tirafondi
Kit metal anchors

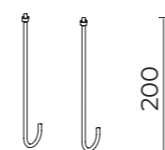

APLOS

APLOS è un floor-washer per camminamenti, scale e rampe caratterizzato da un design minimale che nulla aggiunge all'essenza della sua funzione.

APLOS is a floor-washer for walkways, stairs and ramps, featuring a minimal design that does nothing to alter the essence of its function.





220 240V	50 60Hz	CL I WALL RECESSED	CL II BOLLARD	IP66	IK08	ta -30°C +50°C	CE		ROHS
-------------	------------	--------------------------	------------------	------	------	----------------------	----	--	------

DATI PRESTAZIONALI / PERFORMANCE DATA

Flusso apparecchio / Fitting flux:
250 - 290 lm

Potenza apparecchio / Fitting power:
7,5 W

Indice di resa cromatica / Colour Rendering Index:
CRI ≥ 80, SDCM ≤ 3

Illuminazione intelligente / Smart lighting:
DALI su richiesta / DALI on request

MATERIALI / MATERIALS

Corpo e cover / Body and cover:
pressofusione di lega d'alluminio UNI EN AB 47100 (contenuto rame < 1%), palo in alluminio estruso die-cast aluminum alloy UNI EN AB 47100 (copper content < 1%), extruded aluminium pole

Collimatore ottico / Optical collimator:
nylon PA66

Finitura / Finish:
fosfocromatazione e verniciatura in polveri di poliestere realizzata in 16 fasi per la miglior resistenza agli agenti atmosferici / phospho-chromatation treated and polyester powder-coated in 16 phases to increase weather resistance

CARATTERISTICHE / FEATURES

Peso massimo / Max weight:
1 kg (incasso parete), 4 kg (bollard)
1 kg (wall recessed), 4 kg (bollard)

Alimentazione elettronica / Electronic power supply:
inclusa / included

Precablaggio / Pre-wiring:
versione bollard fornita con cavo e connettore. Versione incasso parete con ingresso cavo posteriore e precablaggio con cavo uscente; predisposizione entra-esce / bollard version is supplied with cable and connector. Wall-recessed version with rear cable entry and pre-wired with outgoing cable; in and out setup

Installazione / Installation:
parete, terra / wall, ground

Fissaggio / Fixing system:
versione bollard con tirafondi / bollard version with metal anchors

TEMPERATURA COLORE / COLOUR TEMPERATURE

- 2700 K
- 3000 K
- 4000 K



INCASSO PARETE
WALL RECESSED



BOLLARD

OTTICHE / OPTICS

AS-D Asymmetric Diffused Beam



Aplos

Incasso parete / Wall recessed

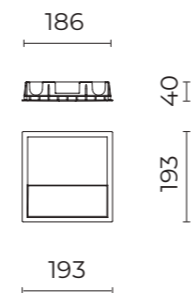

COLORI / COLOURS

-  SABLÉ 100 NOIR
-  RAL9006
-  CORTEN
-  RAL9003

ACCESSORI / ACCESSORIES

06AP902X0
M2 - Connettore IP68 3P CL I
Connector IP68 3P CL I



OTTICHE / OPTICS

AS-D Asymmetric Diffused Beam



Aplos Bollard



COLORI / COLOURS

- SABLÉ 100 NOIR
- RAL9006
- CORTEN

ACCESSORI / ACCESSORIES

O6AP902X0
M2 - Connettore IP68 3P CL I
Connector IP68 3P CL I



O6LT931J0
B168 - Kit tirafondi
Kit metal anchors

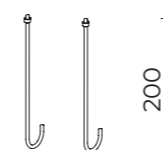



FIN

FIN è un floor-washer per camminamenti, scale e rampe, caratterizzato da un design minimale che nulla aggiunge all'essenza della sua funzione.

FIN is a floor-washer for walkways, stairs and ramps, featuring a minimal design that does nothing to alter the essence of its function.



220 240V	50 60Hz	CL I	IP65	IK08	ta -30°C +50°C
-------------	------------	------	------	------	----------------------



DATI PRESTAZIONALI / PERFORMANCE DATA

Flusso apparecchio / Fitting flux:
1215 - 1300 lm

Potenza apparecchio / Fitting power:
16 W

Indice di resa cromatica / Colour Rendering Index:
CRI ≥ 80, SDCM ≤ 3

CARATTERISTICHE / FEATURES

Peso massimo / Max weight:
4,7 kg (incasso parete), 12 kg (bollard)
4,7 kg (wall recessed), 12 kg (bollard)

Alimentazione elettronica / Electronic power supply:
inclusa / included

Precablaggio / Pre-wiring:
versione bollard fornita con cavo e connettore
bollard version is supplied with cable and connector

Installazione / Installation:
incasso parete, terra / wall recessed, ground

MATERIALI / MATERIALS

Corpo / Body:
pressofusione di lega d'alluminio UNI EN AB 47100
(contenuto rame < 1%), palo in alluminio estruso
die-cast aluminum alloy UNI EN AB 47100 (copper
content < 1%), extruded aluminium pole

Schermo / Screen:
vetro piano sabbiato / sandblasted flat glass

Finitura / Finish:
fosfocromatazione e verniciatura in polveri di poliestere
realizzata in 16 fasi per la miglior resistenza agli
agenti atmosferici / phospho-chromatation treated
and polyester powder-coated in 16 phases to increase
weather resistance

TEMPERATURA COLORE COLOUR TEMPERATURE

- 3000 K
- 4000 K



INCASSO PARETE
WALL RECESSED



BOLLARD

OTTICHE / OPTICS

AS-D Asymmetric Diffused Beam

Fin

Incasso parete / Wall recessed

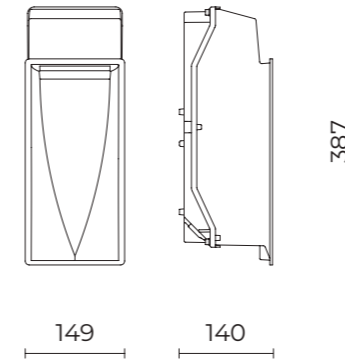

COLORI / COLOURS

- SABLÉ 100 NOIR
- RAL9006
- RAL9003

ACCESSORI / ACCESSORIES

06FI990J0

Controcassa per installazione a parete
Recessed housing for wall-mounting

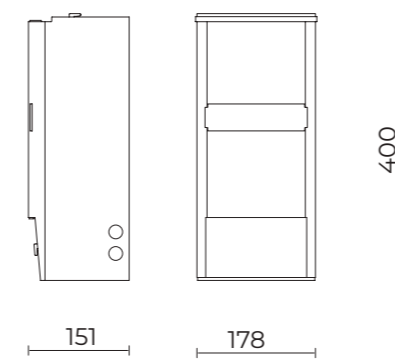



ROME
Italy

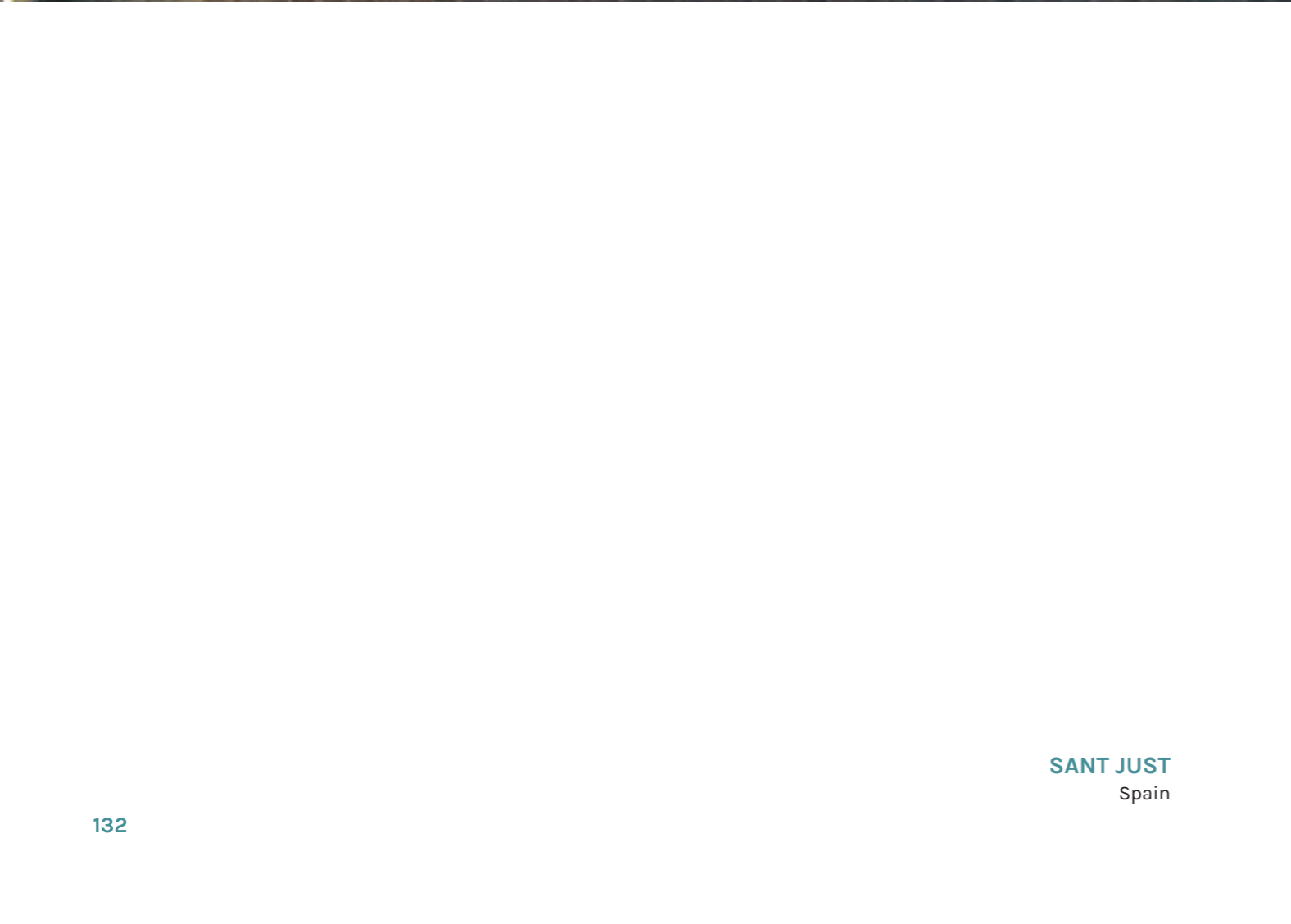

SANT JUST
Spain



OTTICHE / OPTICS

AS-D Asymmetric Diffused Beam



Fin
Bollard

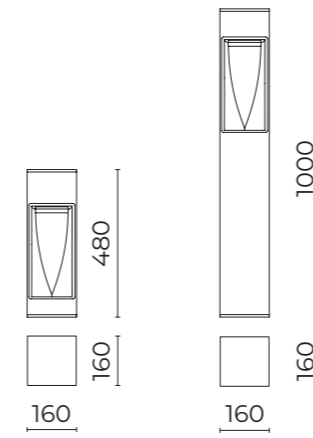

COLORI / COLOURS

- SABLÉ 100 NOIR
- RAL9006

ACCESSORI / ACCESSORIES

06PY999X0
Kit tirafondi
Anchoring bolts kit



FIN XS

FIN XS è un floor-washer dalle dimensioni compatte, ideale per l'illuminazione di camminamenti, scale e rampe.

FIN XS is a compact floor-washer, ideal for lighting walkways, stairs and ramps.



220 240V	50 60Hz	CL II	IP65	IK06	ta -30°C +50°C
-------------	------------	-------	------	------	----------------------



DATI PRESTAZIONALI / PERFORMANCE DATA

Flusso apparecchio / Fitting flux:
95 lm

Potenza apparecchio / Fitting power:
4,5 W

Indice di resa cromatica / Colour Rendering Index:
CRI ≥ 80, SDCM ≤ 3

CARATTERISTICHE / FEATURES



Peso massimo / Max weight:
0,3 kg (incasso parete), 6 kg (bollard)
0,3 kg (wall recessed), 6 kg (bollard)

Alimentazione elettronica / Electronic power supply:
inclusa / included

Precablaggio / Pre-wiring:
versione bollard fornita con cavo e connettore
bollard version is supplied with cable and connector

Installazione / Installation:
incasso parete, terra / wall recessed, ground

COLORI / COLOURS

-  SABLÉ 100 NOIR
-  RAL9006
-  RAL9003
(only wall recessed version)

MATERIALI / MATERIALS

Corpo / Body:
pressofusione di lega d'alluminio UNI EN AB 47100
(contenuto rame < 1%), palo in alluminio estruso
die-cast aluminum alloy UNI EN AB 47100 (copper
content < 1%), extruded aluminium pole

Schermo / Screen:
vetro piano sabbato / sandblasted flat glass

Finitura / Finish:
fosfocromatazione e verniciatura in polveri di poliestere
realizzata in 16 fasi per la miglior resistenza agli
agenti atmosferici / phospho-chromatation treated
and polyester powder-coated in 16 phases to increase
weather resistance

TEMPERATURA COLORE COLOUR TEMPERATURE

-  3000 K
-  4000 K



INCASSO PARETE
WALL RECESSED



BOLLARD

Fin

Incasso Parete / Wall recessed

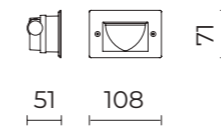

Bollard

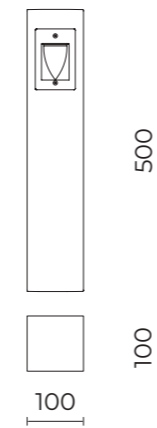

ACCESSORI / ACCESSORIES

06PY999X0

Kit tirafondi

Anchoring bolts kit

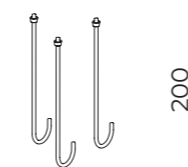



SUKOŠAN
Croatia



VODICE
Croatia



SAVONA
Italy

IBIZA
Spain



EKLEIPSIS

EKLEIPSIS sembra modellata dalla sua stessa luce, come se la luce avesse eroso il metallo in cui era imprigionata per uscirne fuori morbidamente.

EKLEIPSIS seems to be modelled by his own light, as if the light had eroded the metal in which it was imprisoned to come out softly.







* Bollard, pole

** Bollard small

DATI PRESTAZIONALI / PERFORMANCE DATA**Flusso apparecchio / Fitting flux:**

444 - 2073 lm

Potenza apparecchio / Fitting power:

13 - 50 W

Indice di resa cromatica / Colour Rendering Index:

CRI ≥ 80, SDCM ≤ 3

Illuminazione intelligente / Smart lighting:DALI su richiesta (medium, large) / DALI on request
(medium, large)**TEMPERATURA COLORE
COLOUR TEMPERATURE**

2700 K

3000 K

4000 K

MATERIALI / MATERIALS**Corpo / Body:**pressofusione di lega d'alluminio UNI EN AB 47100
(contenuto rame < 1%), palo in alluminio estruso
die-cast aluminum alloy UNI EN AB 47100 (copper
content < 1%) extruded aluminium pole**Gruppo ottico / Optical unit:**

lente in policarbonato / polycarbonate lens

Finitura / Finish:fosfocromatazione e verniciatura in polveri di poliestere
realizzata in 16 fasi per la miglior resistenza agli
agenti atmosferici / phospho-chromatation treated
and polyester powder-coated in 16 phases to increase
weather resistance**CARATTERISTICHE / FEATURES****Alimentazione elettronica / Electronic power supply:**

inclusa / included

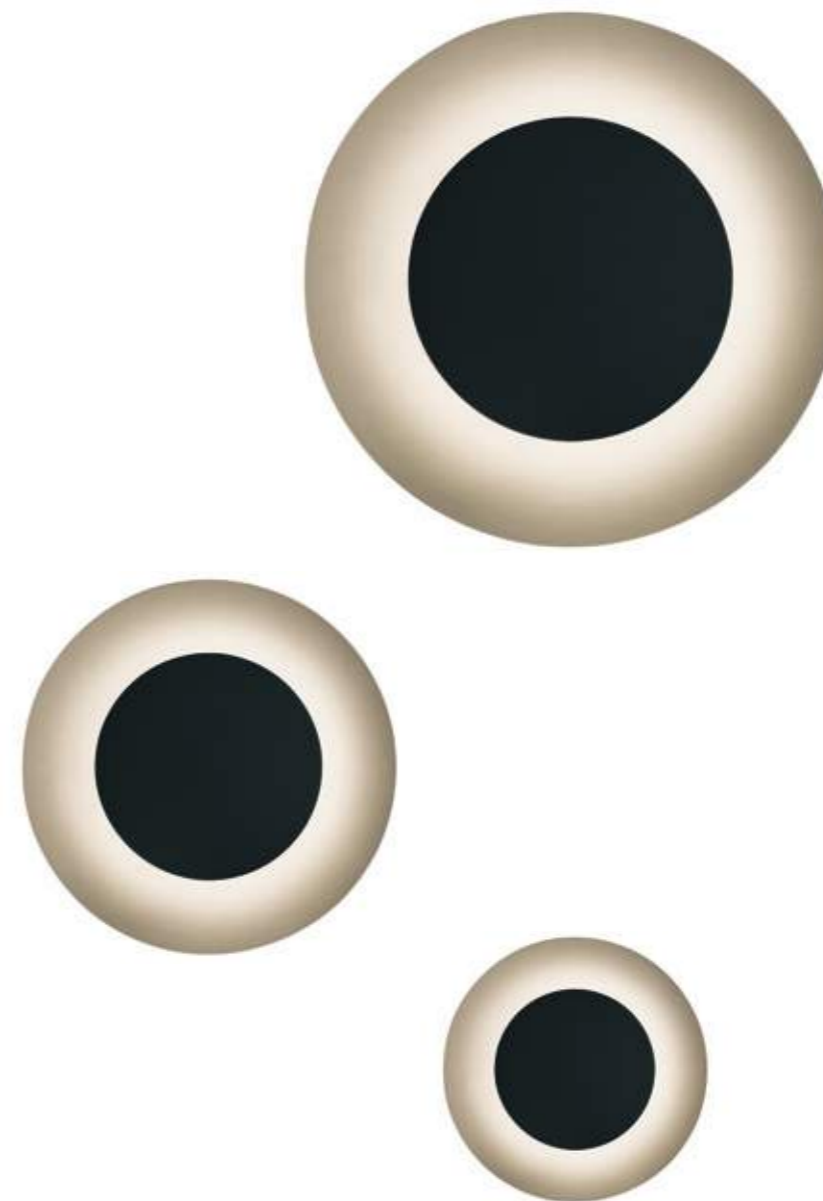
Installazione / Installation:parete, soffitto, bollard, palo / wall, ceiling,
bollard, pole



Ekleipsis

Parete / Wall



SMALL

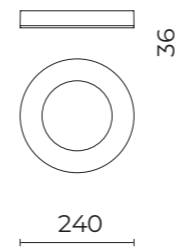

MEDIUM

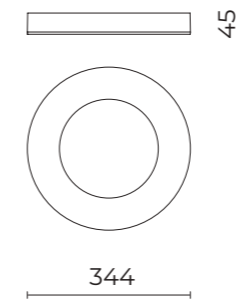

LARGE

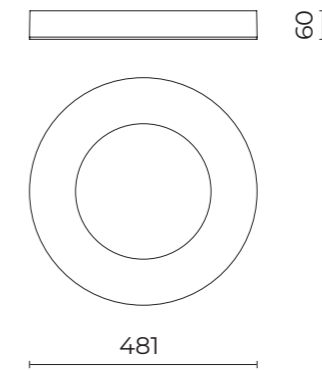

DATI TECNICI / TECHNICAL DATA

Peso massimo / Max weight:
1,3 kg (small), 2,4 kg (medium), 5 kg (large)

Installazione / Installation:
parete / wall-mounted

COLORI / COLOURS

- SABLÉ 100 NOIR
- RAL9006
- RAL9003



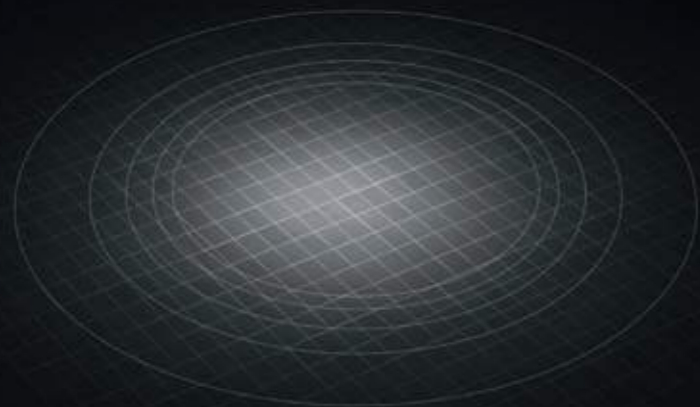

Ekleipsis
Soffitto / Ceiling



SMALL

MEDIUM

LARGE

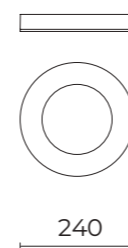

36

240

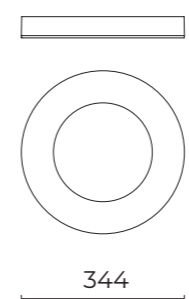

45

344

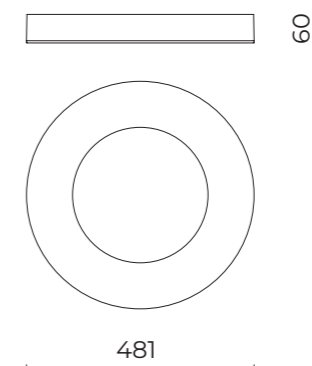

60

481

DATI TECNICI / TECHNICAL DATA

Peso massimo / Max weight:
1,3 kg (small), 2,4 kg (medium), 5 kg (large)

Installazione / Installation:
soffitto / ceiling-mounted

COLORI / COLOURS

-  SABLÉ 100 NOIR
-  RAL9006
-  RAL9003



OTTICHE / OPTICS

R-D Rotosymmetric Diffused Beam

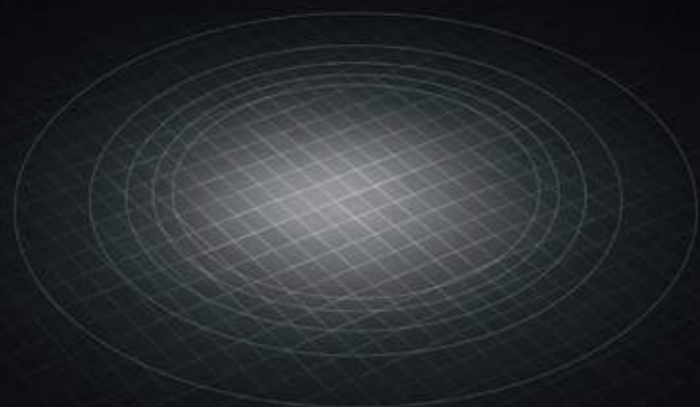

Ekleipsis

Incasso soffitto / Ceiling recessed

SMALL

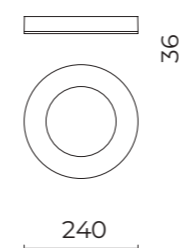

MEDIUM

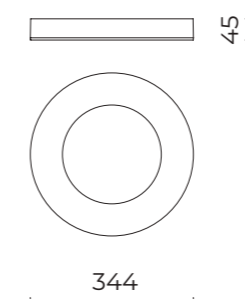

LARGE

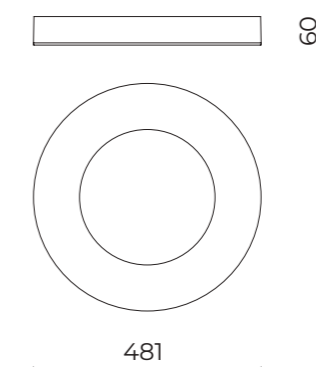

DATI TECNICI / TECHNICAL DATA

Peso massimo / Max weight:
1,3 kg (small), 2,4 kg (medium), 5 kg (large)

Installazione / Installation:
incasso soffitto / ceiling-recessed

COLORI / COLOURS

- SABLÉ 100 NOIR
- RAL9006
- RAL9003

ACCESSORI / ACCESSORIES

Kit incasso per soffitti in cartongesso
Recessed kit for plasterboard ceilings

06EK900J
Small

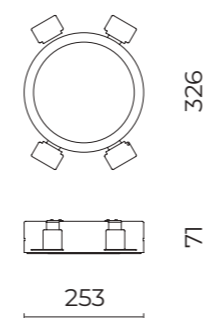

06EK901J
Medium

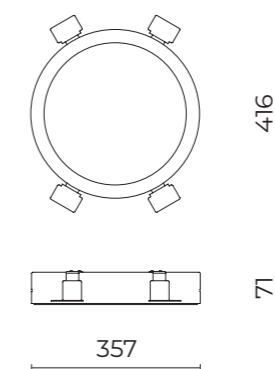

06EK902J
Large

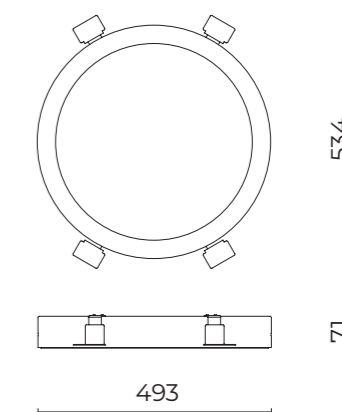



SUKOŠAN
Croatia



BRATISLAVA
Slovakia



BERGAMO
Italy



VIC
Spain

OTTICHE / OPTICS

R-D Rotosymmetric Diffused Beam

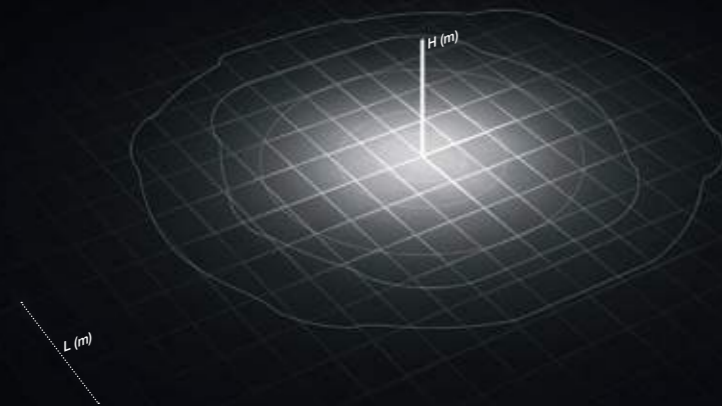

Ekleipsis
Bollard

SMALL 500

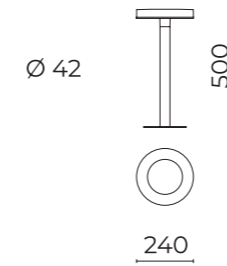

SMALL 1000

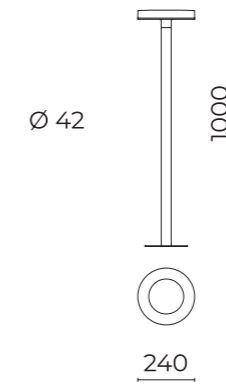

MEDIUM 1000

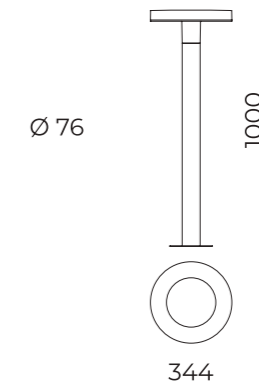

DATI TECNICI / TECHNICAL DATA

Peso massimo / Max weight:
7,5 kg (small), 16 kg (medium)

Protezione contro le sovratensioni
Surge Protection Device:
MC 6 kV (small), 3 kV (medium)
MD 10 kV (small), 8 kV (medium)

Installazione / Installation:
terra, con piastra di base
ground, with base plate

COLORI / COLOURS

- SABLÉ 100 NOIR
- RAL9006



OTTICHE / OPTICS

R-D Rotosymmetric Diffused Beam

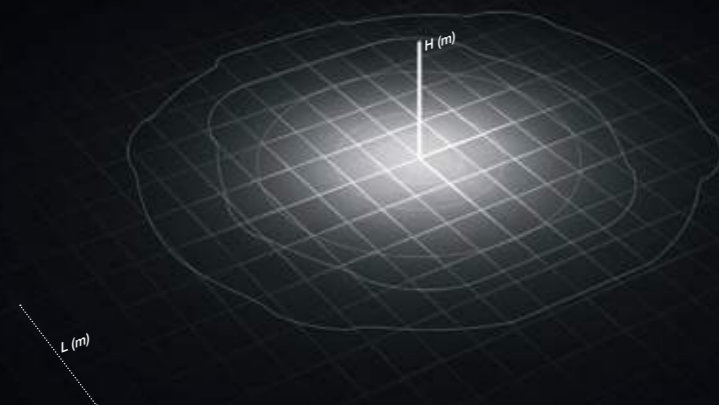

Ekleipsis
Palo / Pole

MEDIUM

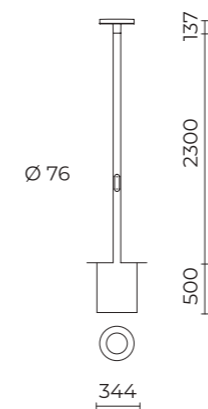

LARGE

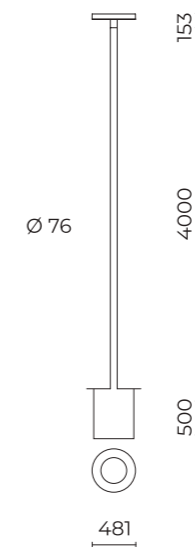

DATI TECNICI / TECHNICAL DATA

Peso massimo / Max weight:
16 kg (medium), 34 kg (large)

Protezione contro le sovratensioni
Surge Protection Device:
MC 3 kV (medium), 4 kV (large)
MD 8 kV

Installazione / Installation:
terra, mediante interrimento
ground, with buried pole

COLORI / COLOURS

- SABLÉ 100 NOIR
- RAL9006



OMIKRON MINI

Il proiettore della linea OMIKRON per installazione a terra, parete e su palo pensato per valorizzare elementi architettonici e naturali, enfatizzare facciate e camminamenti.

Floodlight belonging to OMIKRON line and designed for ground, wall-mounted or pole-mounted installation. It's ideal for enhancing architectural and natural elements and emphasising facades and walkways.





MILAN
Italy



BERGAMO
Italy

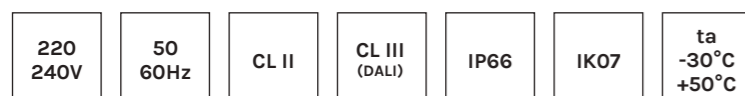

DATI PRESTAZIONALI / PERFORMANCE DATA

Flusso apparecchio / Fitting flux:
75 - 545 lm

Potenza apparecchio / Fitting power:
4,2 - 7,8 W

Indice di resa cromatica / Colour Rendering Index:
CRI ≥ 80, SDCM ≤ 3

Illuminazione intelligente / Smart lighting:
DALI, driver esterno / DALI, external driver

TEMPERATURA COLORE COLOUR TEMPERATURE



CARATTERISTICHE / FEATURES

Peso massimo / Max weight:
1 kg, 1,5 kg (bollard)

Alimentazione elettronica / Electronic power supply:
inclusa (opzione ON-OFF) / included (ON-OFF option)

Precablaggio / pre-wiring:
incluso, fornito con cavo 1,5 m
included, provided with 1,5 m cable

Installazione / Installation:
terra, parete, palo / ground, wall, pole

MATERIALI / MATERIALS

Corpo e sistemi di fissaggio / Body and fitting system:
pressofusione di lega d'alluminio UNI EN AB 47100
(contenuto rame < 1%) / die-cast aluminum alloy UNI EN
AB 47100 (copper content < 1%)

Schermo / Screen:
vetro piano temprato / tempered flat glass

Gruppo ottico / Optical unit:
lenti PMMA ad alta trasparenza
high-transparency PMMA lenses

Finitura / Finish:
fosfocromatazione e verniciatura in polveri di poliestere
realizzata in 16 fasi per la miglior resistenza agli
agenti atmosferici / phospho-chromatation treated
and polyester powder-coated in 16 phases to increase
weather resistance



OTTICHE / OPTICS

C 10° Narrow Beam

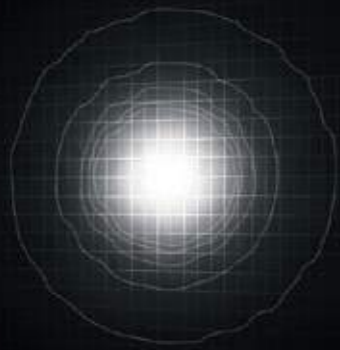

M 25° Medium Beam

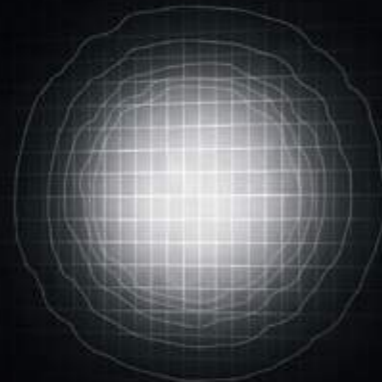

U-D 90° Diffused Beam

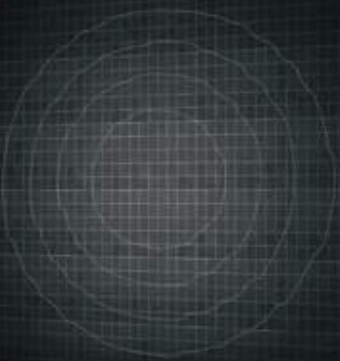

Blade 6°x90° *



* optic available only in 3000 K and 4000 K.

Omikron mini
Flood

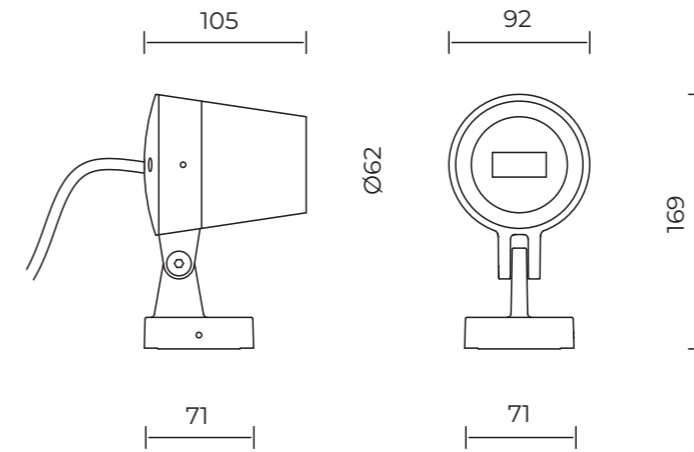

ACCESSORI / ACCESSORIES

06OM902X0
D6 - Driver DALI 20W 24V
IP20 max 2 Omikron mini
DALI driver 20W 24V IP20
max 2 Omikron mini

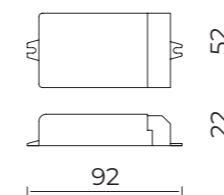

06OM903X0
D7 - Kit driver DALI 20W 24V
IP67 max 2 mini
Driver kit DALI 20W 24V IP67
max 2 Omikron mini

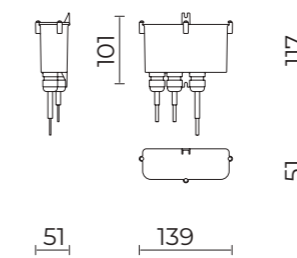

06AK957B0
I2 - Picchetto per interramento
Spike for ground

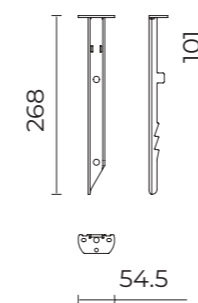

06GC902X0
B165 - Connettore 2 poli IP68
2 pole connector IP68

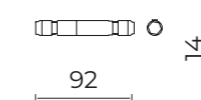

COLORI / COLOURS

- SABLÉ 100 NOIR
- RAL9006
- CORTEN
- RAL9003



OTTICHE / OPTICS

M 25° Medium Beam

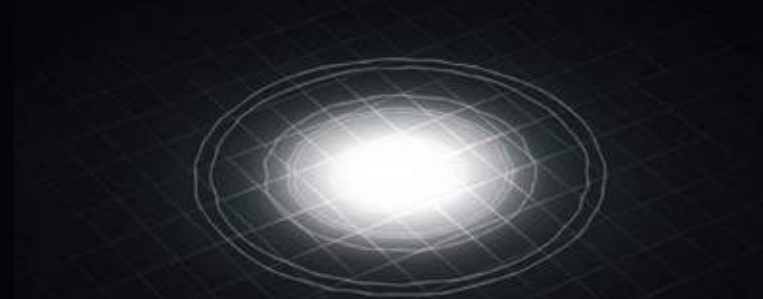

U-D 90° Diffused Beam



Omikron mini
Bollard

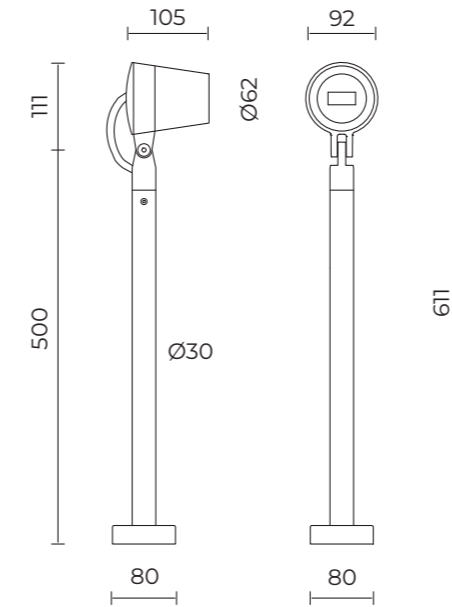

COLORI / COLOURS

- SABLÉ 100 NOIR
- RAL9006

ACCESSORI / ACCESSORIES

060M902X0
D6 - Driver DALI 20W 24V
IP20 max 2 Omikron mini
DALI driver 20W 24V IP20
max 2 Omikron mini

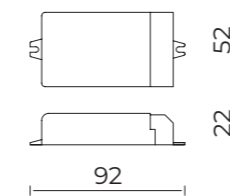

06GC902X0
B165 - Connettore 2 poli
2 pole connector

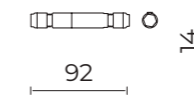

060M903X0
D7 - Kit driver DALI 20W 24V
IP67 max 2 Omikron mini / Driver kit
DALI 20W 24V IP67 max 2 Omikron mini

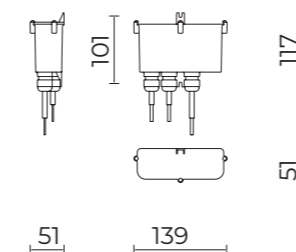



Omikron mini
Pole

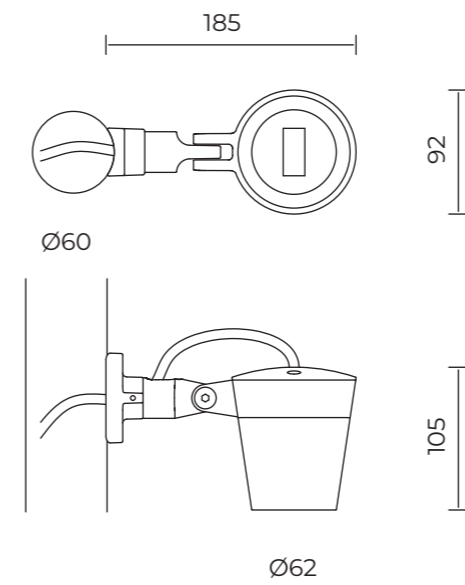

ACCESSORI / ACCESSORIES

060M902X0
D6 - Driver DALI 20W 24V
IP20 max 2 Omikron mini
DALI driver 20W 24V IP20
max 2 Omikron mini

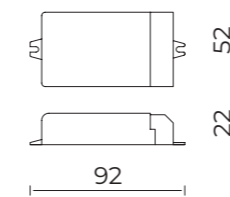

06GC902X0
B165 - Connettore 2 poli
2 pole connector

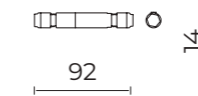

060M903X0
D7 - Kit driver DALI 20W 24V
IP67 max 2 Omikron mini
Driver kit DALI 20W 24V IP67
max 2 Omikron mini

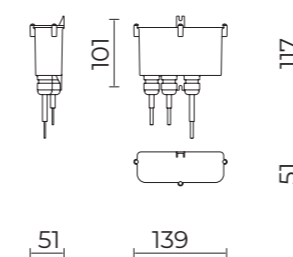

COLORI / COLOURS

- SABLÉ 100 NOIR
- RAL9006



OMIKRON

Una soluzione compatta e flessibile per valorizzare lo spazio attraverso l'illuminazione d'accento e diffusa di facciate, spazi urbani e aree verdi.

Compact and flexible solution to enhance spaces through accent and diffuse lighting of facades, urban spaces and green areas.





DATI PRESTAZIONALI / PERFORMANCE DATA

Flusso apparecchio / Fitting flux:
1210 - 1310 lm

Potenza apparecchio / Fitting power:
20W

Indice di resa cromatica / Colour Rendering Index:
CRI ≥ 90, SDCM ≤ 3

Illuminazione intelligente / Smart lighting:
DALI su richiesta / DALI on request

TEMPERATURA COLORE COLOUR TEMPERATURE

- 2700 K
- 3000 K
- 4000 K

MATERIALI / MATERIALS

Corpo e sistemi di fissaggio / Body and fitting system:
pressofusione di lega d'alluminio UNI EN AB 47100
(contenuto rame < 1%) / die-cast aluminum alloy UNI EN
AB 47100 (copper content < 1%)

Schermo / Screen:
vetro piano temprato
tempered flat glass

Gruppo ottico / Optical unit:
lente in tecnopolimero ad alta trasparenza
highly transparent technopolymer lens

Finitura / Finish:
fosfocromatazione e verniciatura in polveri di poliestere
realizzata in 16 fasi per la miglior resistenza agli
agenti atmosferici / phospho-chromatation treated
and polyester powder-coated in 16 phases to increase
weather resistance

COLORI / COLOURS

- SABLÉ 100 NOIR

CARATTERISTICHE / FEATURES

Peso massimo / Max weight:
2 kg

Alimentazione elettronica / Electronic power supply:
inclusa / included

Precablaggio / pre-wiring:
prodotto pre-cablato con cavo
pre-wired product with cable

Installazione / Installation:
terra, parete, palo / ground, wall, pole



OTTICHE / OPTICS

C 10° Narrow Beam

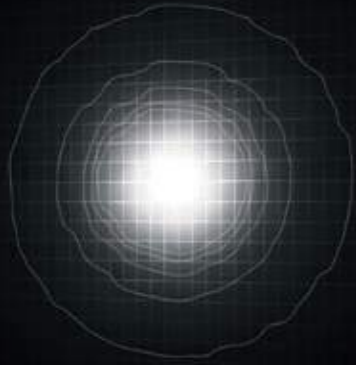

D 45° Wide Beam

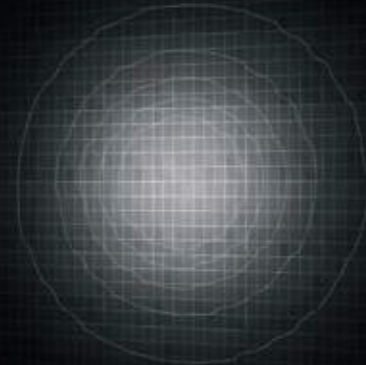

M 25° Medium Beam

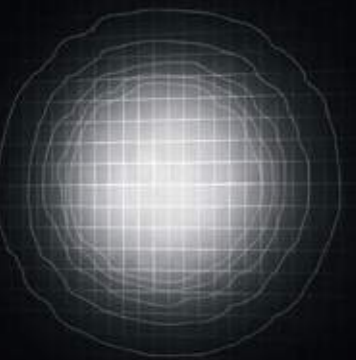

U-D 90° Diffused Beam

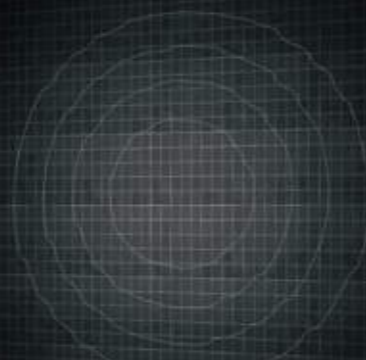

Omikron
Flood / Pole

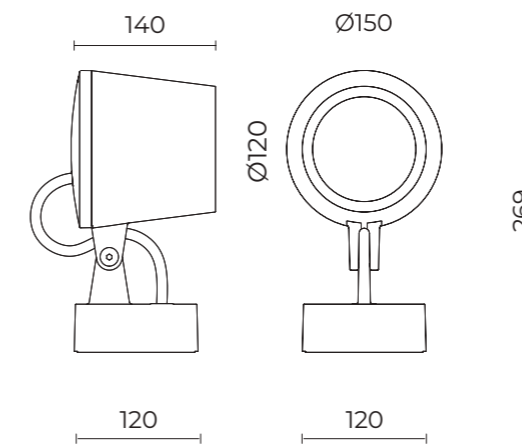

DATI TECNICI / TECHNICAL DATA

Installazione / Installation:
terra, parete, palo (Ø 102 mm) con accessorio
ground, wall-mounted, pole (Ø 102 mm) with accessory

Disponibili, su richiesta, versioni con honeycomb
On request, are available versions with honeycomb

Inclinazione / Inclination:
+90° ÷ -45°, rotazione ±30°
+90° ÷ -45°, rotation ±30°



ACCESSORI / ACCESSORIES

060M904C0
B136 Anello per palo Ø 102 mm
Single pole ring for pole Ø 102 mm

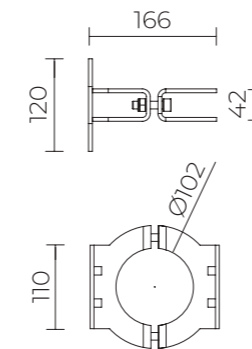

060M905C0
Anello doppio per palo Ø 102 mm
Double pole ring for pole Ø 102 mm

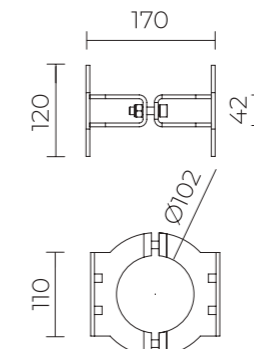

06KS918C0
B137 - Connettore 2 vie IP68
2-way connector IP68

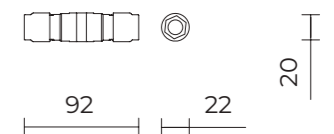

060M901C0
B135 - Picchetto per interramento
Spike for ground installation

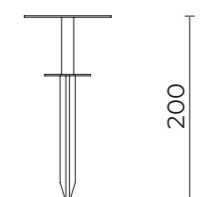

KLAIPEDA
Lithuania



NOLI
Italy



OTTICHE / OPTICS

C 10° Narrow Beam



D 45° Wide Beam

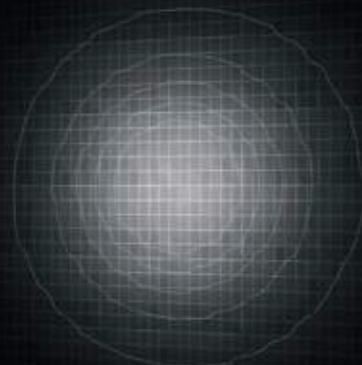

M 25° Medium Beam

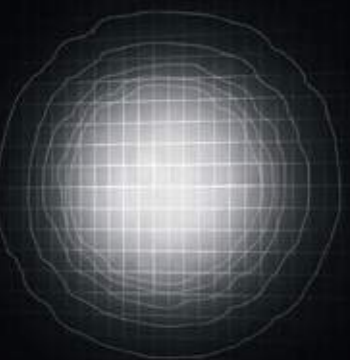

U-D 90° Diffused Beam

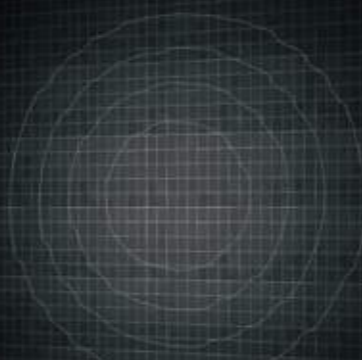

Omikron
Pole

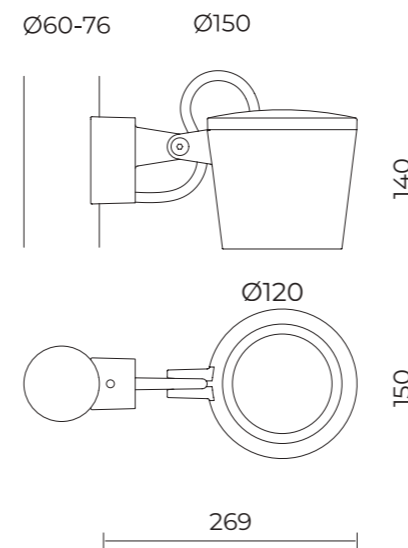

DATI TECNICI / TECHNICAL DATA

Installazione / Installation:
palo Ø 60 - 76 mm / pole Ø 60-76 mm

Disponibili, su richiesta, versioni con honeycomb
On request, are available versions with honeycomb

Inclinazione / Inclination:
+90° ÷ -45°

ACCESSORI / ACCESSORIES

06KS918C0
B137 - Connettore 2 vie IP68
2-way connector IP68

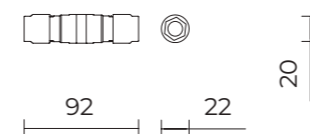

OMIKRON PRO

OMIKRON PRO è il nuovo proiettore della linea Omikron pensato per illuminare facciate, percorsi e spazi urbani.

OMIKRON PRO is the new floodlight in the Omikron line designed to illuminate façades, walkways and urban spaces.







DATI PRESTAZIONALI / PERFORMANCE DATA

Flusso apparecchio / Fitting flux:
1695 - 3970 lm

Potenza apparecchio / Fitting power:
19 - 36 W

Indice di resa cromatica / Colour Rendering Index:
CRI ≥ 80, SDCM ≤ 3

Illuminazione intelligente / Smart lighting:
DALI

MATERIALI / MATERIALS

Corpo e sistemi di fissaggio / Body and fitting system:
pressofusione di lega d'alluminio UNI EN AB 47100
(contenuto rame < 1%) / die-cast aluminum alloy UNI EN
AB 47100 (copper content < 1%)

Schermo / Screen:
vetro piano temprato / tempered flat glass

Gruppo ottico / Optical unit:
lenti PMMA ad alta trasparenza
high-transparency PMMA lenses

Finitura / Finish:
fosfocromatazione e verniciatura in polveri di poliestere
realizzata in 16 fasi per la miglior resistenza agli
agenti atmosferici / phospho-chromatation treated
and polyester powder-coated in 16 phases to increase
weather resistance

TEMPERATURA COLORE COLOUR TEMPERATURE

- 2700 K
- 3000 K
- 4000 K

COLORI / COLOURS

- SABLÉ 100 NOIR
- RAL9006

CARATTERISTICHE / FEATURES

Peso massimo / Max weight:
4,1 kg

Alimentazione elettronica / Electronic power supply:
inclusa / included

Resistenza sovratensioni / Surge Protection Device:
MC 10 kV
MD 6 kV

Precablaggio / pre-wiring:
prodotto pre-cablato con cavo e connettore
pre-wired product with cable and connector

Installazione / Installation:
terra, parete, palo / ground, wall, pole



OTTICHE / OPTICS

U-C 6° Ultra-Narrow Beam



D 40° Wide Beam



C 11° Narrow Beam



U-D 90° Diffused Beam



M 25° Medium Beam



Omikron pro
Flood

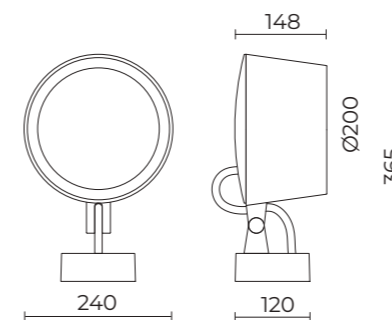

DATI TECNICI / TECHNICAL DATA

Installazione / Installation:
terra, parete / ground

Inclinazione / Inclination:
-90° ÷ +45°, rotazione +15° ÷ -15°
+90° ÷ -45°, rotation +15° ÷ -15°

ACCESSORI / ACCESSORIES

060M901C0
B135 - Picchetto per interrimento
Spike for ground installation

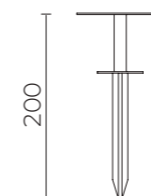

06KS909C0
B89 - Connettore 4 vie IP68
4-way connector IP68

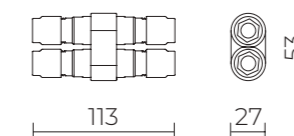

U-C 6° Ultra-Narrow Beam



D 40° Wide Beam



C 11° Narrow Beam



U-D 90° Diffused Beam



M 25° Medium Beam



Omikron pro Pole

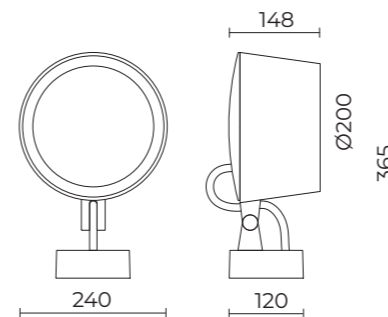

DATI TECNICI / TECHNICAL DATA

Installazione / Installation:
palo Ø 102 mm / pole Ø 102 mm

Inclinazione / Inclination:
+90° ÷ -45°, rotazione +15° ÷ -15°
+90° ÷ -45°, rotation +15° ÷ -15°

ACCESSORI / ACCESSORIES

060M904C0
B136 - Anello per palo
Ring for pole

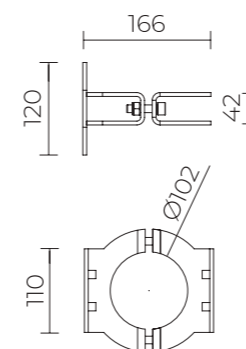

060M905C0
B137 - Anello doppio per palo
Double ring for pole

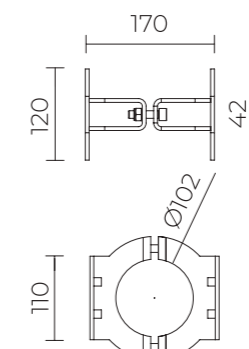

06KS909C0
B89 - Connettore 4 vie IP68
4-way connector IP68

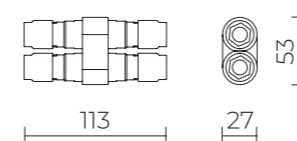

SIGMA

Una forma senza tempo, declinata in un sistema completo e flessibile, rende SIGMA una soluzione per l'illuminazione di ogni ambiente urbano.

A timeless shape divided into a complete and flexible system makes SIGMA a lighting solution for any urban environment.





DATI PRESTAZIONALI / PERFORMANCE DATA



Flusso apparecchio / Fitting flux:
1695 - 11485 lm

Potenza apparecchio / Fitting power:
19 - 107 W

Indice di resa cromatica / Colour Rendering Index:
CRI ≥ 80, SDCM ≤ 3

Illuminazione intelligente / Smart lighting:
DALI

TEMPERATURA COLORE COLOUR TEMPERATURE

-  2700 K
-  3000 K
-  4000 K

MATERIALI / MATERIALS

Corpo e sistemi di fissaggio / Body and fitting system:
pressofusione di lega d'alluminio UNI EN AB 47100
(contenuto rame < 1%) / die-cast aluminium alloy UNI
EN AB 47100 (copper content < 1%)

Schermo / Screen:
vetro piano temprato / tempered flat glass

Gruppo ottico / Optical unit:
lenti PMMA ad alta trasparenza
high-transparency PMMA lenses

Finitura / Finish:
fosfocromatazione e verniciatura in polveri di
poliestere realizzata in 16 fasi per la miglior resistenza
agli agenti atmosferici / phospho-chromatation
treated and polyester powder-coated in 16 phases to
increase weather resistance

COLORI / COLOURS

-  SABLÉ 100 NOIR

CARATTERISTICHE / FEATURES

Peso massimo / Max weight:
5,1 kg (small), 9,1 kg (medium)

Alimentazione elettronica / Electronic power supply:
inclusa / included

Precablaggio / Pre-wiring:
prodotto precablato con cavo e connettore
pre-wired product with cable and connector

Installazione / Installation:
terra, parete, palo / ground, wall, pole



OTTICHE / OPTICS

U-C 6° Ultra-Narrow Beam



U-D 90° Diffused Beam



C 11° Narrow Beam



W-W Wall Washer



M 25° Medium Beam



E 12°x 50° Ellipsoidal Beam



D 40° Wide Beam

Sigma
Flood

SMALL

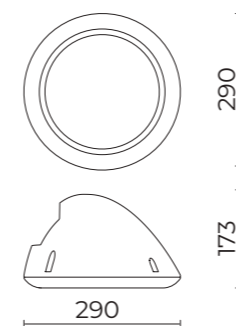

MEDIUM

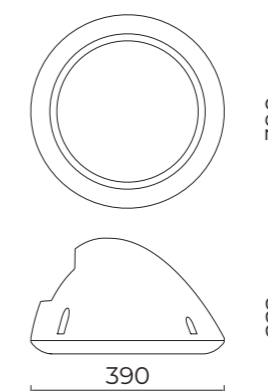
**Inclination:**

-90° ÷ +35°; rotazione ±30°

-90° ÷ +35°, rotation ±30°

Rotazione ottica ellissoidale / Ellipsoidal optics rotation:

possibilità di rotazione di 360° dell'ottica ellissoidale dall'esterno, senza l'uso di utensili, con il prodotto installato ed acceso per l'ottimizzazione del puntamento
the ellipsoidal optic can be rotated on 360° from outside, without the use of tools, while product is installed and switched on for pointing optimisation



Sigma
Flood

ACCESSORIES

06SG903CO
B127 - Base di fissaggio ruotabile ±30°
 Fixing base which can be rotated ±30°

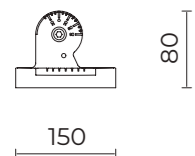

06SG904CO
B128 - Giunto per picchetto
 Joint for spike

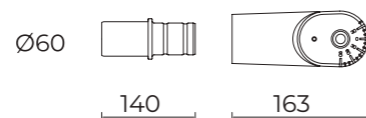

06LT908CO
B117 - Picchetto per interrimento
 Spike for ground installation

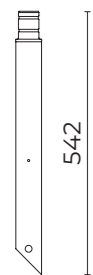

06LT909JO
B118 - Ancore per calcestruzzo
 Anchor for concrete

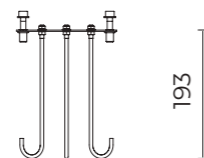

06KS909CO
B89 - Connettore 4 vie IP68
 4-way connector IP68

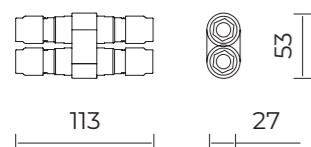

OTTICHE / OPTICS

U-C 6° Ultra-Narrow Beam



U-D 90° Diffused Beam



C 11° Narrow Beam



W-W Wall Washer



M 25° Medium Beam



E 12°x 50° Ellipsoidale Beam



D 40° Wide Beam

Sigma
Pole

SMALL

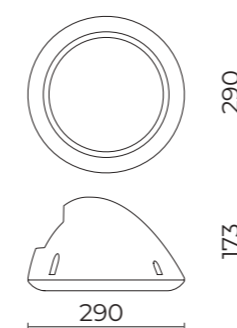

MEDIUM

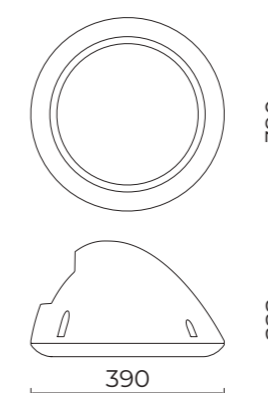

DATI TECNICI / TECHNICAL DATA

Installazione / Installation:

con accessorio 06SG904C0 su bracci Ø 60 mm, per pali Ø 60 - 76 - 102 mm / with accessory 06SG904C0 on arms Ø 60 mm, for poles Ø 60 - 76 - 102 mm

Inclinazione / Inclination:

-90° ÷ -35

Rotazione ottica ellissoidale / Ellipsoidal optics rotation:

possibilità di rotazione di 360° dell'ottica ellissoidale dall'esterno, senza l'uso di utensili, con il prodotto installato ed acceso per l'ottimizzazione del puntamento / the ellipsoidal optic can be rotated on 360° from outside, without the use of tools, while product is installed and switched on for pointing optimisation

ACCESSORI / ACCESSORIES

06SG904C0

B128 - Giunto orientabile
Adjustable joint

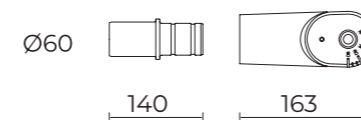
**06KS909C0**

B89 - Connettore 4 vie IP68
4-way connector IP68

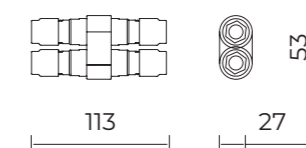

Sigma
Pole

ACCESSORI E BRACCI / ACCESSORIES AND ARMS

01AK903CO
L3 - Kit giunto per palo
Joint kit for pole

Ø60÷76

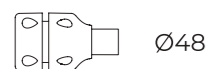

142

01AK904CO
L4 - Kit giunto doppio per palo
Double joint kit for pole

Ø60÷76

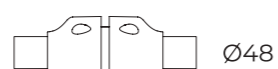

170

01AK921CO
B1 - Braccio per pali
Arm for poles

Ø60÷76

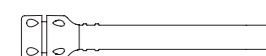

550

01AK922CO
B2 - Braccio doppio per pali
Double arm for poles

Ø60÷76



550

550

06AK916CO
B139 - Anello per pali
Ring for poles

Ø102



06AK917CO
B140 - Anello doppio per pali
Double ring for poles

Ø102



06AK907CO
B155 - Braccio per pali
Arm for poles

Ø102



550

06AK909CO
B157 - Braccio doppio per pali
Double arm for poles

Ø102



550

550



LEVANTE 2.0

LEVANTE 2.0 è un sistema completo e flessibile per l'illuminazione di vuoti e pieni urbani: percorsi, spazi e architetture. I sistemi ottici per proiezione sono disponibili anche in RGBW. Le versioni ECO-CENTRIC LIGHTING di LEVANTE 2.0 tutelano la biodiversità e il benessere degli esseri umani.

LEVANTE 2.0 is a complete and flexible system for lighting empty and full urban locations, such as pathways, spaces and architecture. Its projection optical systems are also available in RGBW. The ECO-CENTRIC LIGHTING versions of LEVANTE 2.0 protect biodiversity and human well-being.





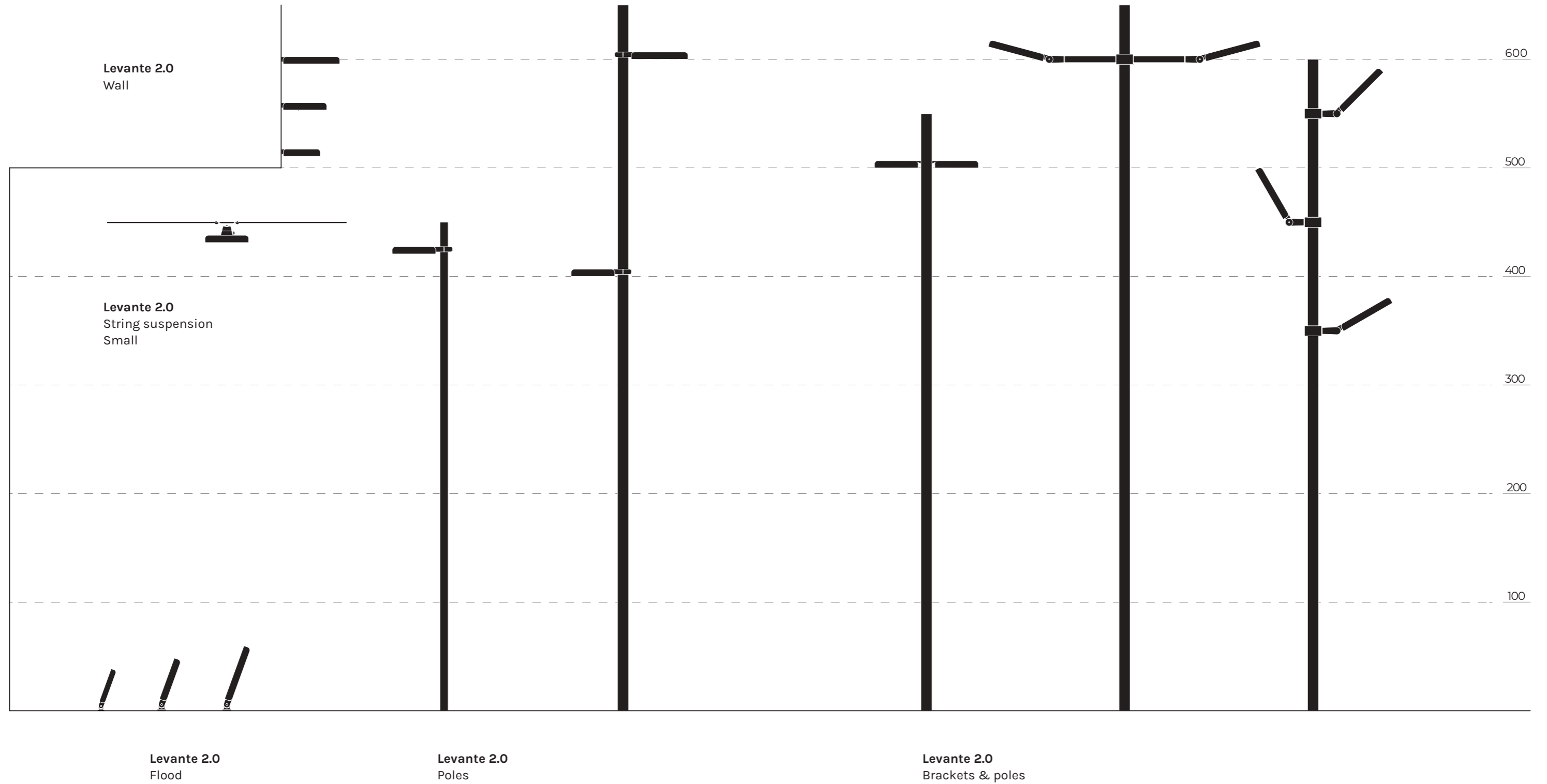

220-240V 24V (RGBW)	50 60Hz	CL II	CL I (RGBW)	IP66	IK09	ta -30°C +50°C	CE	WEEE	ROHS	03	PLUS 03	NFC
------------------------	------------	-------	----------------	------	------	----------------------	----	------	------	----	------------	-----

DATI PRESTAZIONALI / PERFORMANCE DATA

Flusso apparecchio / Fitting flux:
1670 - 23180 lm

Potenza apparecchio / Fitting power:
12 - 155 W

Indice di resa cromatica / Colour Rendering Index:
≥ 70, SDCM ≤ 3 (ottiche stradali) / (street optics)
≥ 80, SDCM ≤ 3 (ottiche proiezione) / (projection optics)

Illuminazione intelligente / Smart lighting:
mezzanotte virtuale, DALI. Su richiesta ZHAGA, CLO, PLC, telegestione wireless, sensori / virtual midnight, DALI. On request ZHAGA, CLO, PLC, wireless telemanagement, detectors

MATERIALI / MATERIALS

Corpo e sistemi di fissaggio / Body and fitting system:
pressofusione di lega d'alluminio UNI EN AB 47100 (contenuto rame < 1%) / die-cast aluminium alloy UNI EN AB 47100 (copper content < 1%)

Schermo / Screen:
vetro piano temprato / tempered flat glass

Gruppo ottico / Optical unit:
lenti PMMA ad alta trasparenza
PMMA high transparent lenses

Finitura / Finish:
fosfocromatazione e verniciatura in polveri di poliestere realizzata in 16 fasi per la miglior resistenza agli agenti atmosferici / phospho-chromatation treated and polyester powder-coated in 16 phases to increase weather resistance

**TEMPERATURA COLORE
COLOUR TEMPERATURE**

- 2200 K
- 2700 K
- 3000 K
- 4000 K
- RGB+W 3000 K

**ECO-CENTRIC LIGHTING (ECL)
(ONLY FOR STREET OPTICS)**

BLUE FREE LIGHT:
PC-AMBER 0,7% ΣR (λ < 500NM) – CRI 40
1800 K 4,3% ΣR (λ < 500NM) – CRI 70

SWITCHABLE WHITE LIGHT:
1800K / 3000K

COLORE / COLOUR

- SABLÉ 100 NOIR



CARATTERISTICHE / FEATURES

Peso massimo / Max weight:
3.6 kg (x-small), 6 kg (small), 9 kg (medium)

Alimentazione elettronica / Electronic power supply:
inclusa, esterna nelle versioni RGBW / included, remote for RGBW versions

Installazione / Installation:
parete, terra, soffitto, palo, sospensione tesata
wall, ground, ceiling, pole, string suspension

Levante 2.0

OTTICHE / OPTICS

U-C 6° Ultra-narrow Beam



D 40° Wide Beam



C 11° Narrow Beam



U-D 90° Diffused Beam

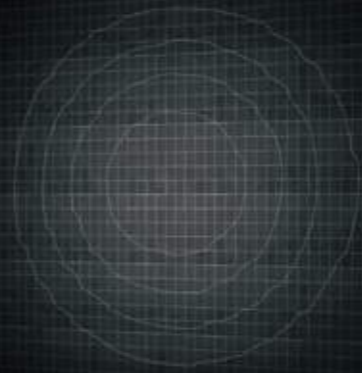

M 25° Medium Beam

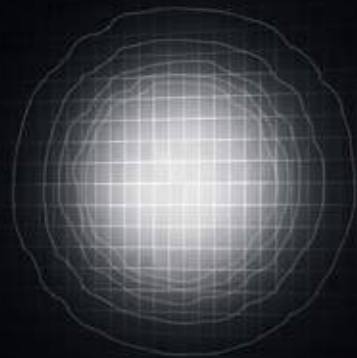

W-W Wall Washer



OTTICHE / OPTICS

LT-C1 Cycle Path
L / H = 0,5

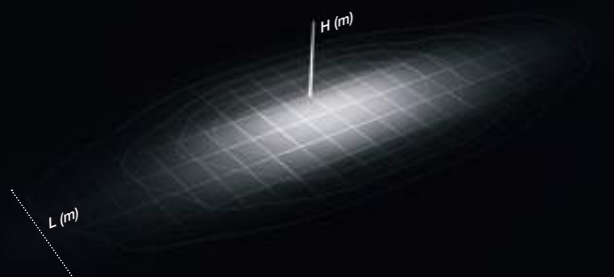

ST-02 Narrow Street
L / H = 0,75 ECL

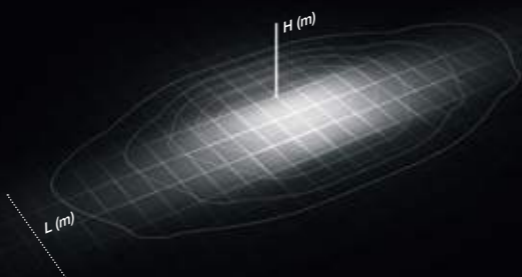

LT-63 Asymmetric Beam
L / H = 2 ECL

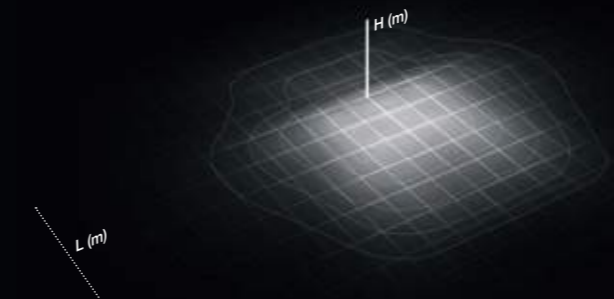

AP-D2 Pedestrian Crossing

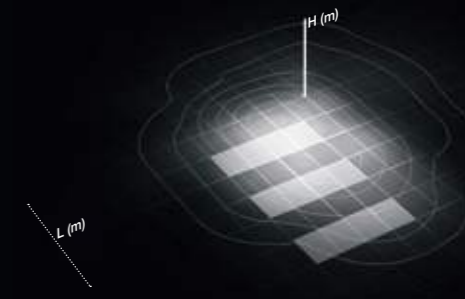

ME-05 Medium Street
L / H = 1 ECL

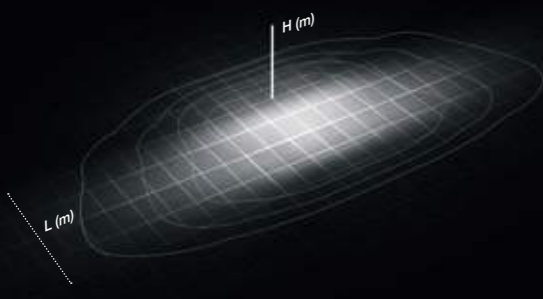

ME-06 Medium Street with sidewalk
L / H = 1

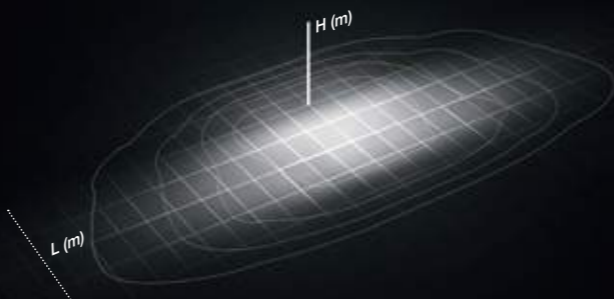

LT-64 Asymmetric beam with backlight
L / H = 2 ECL

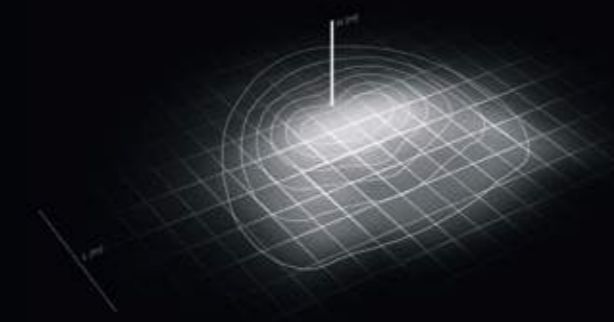

AP-S2 Pedestrian Crossing

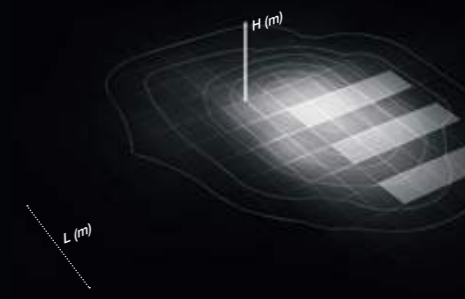

LA-03 Wide Street
L / H = 1,25 ECL

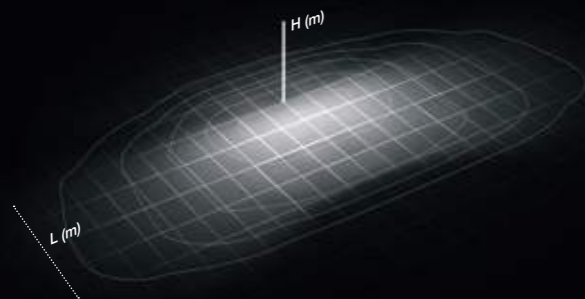

PB-01 Low Pole
L / H = 2

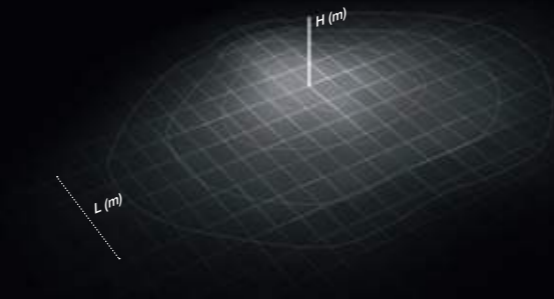

SO-02 Street Centered



*Levante 2.0 è un sistema modulare e componibile. Il progettista può combinare qualsiasi distribuzione luminosa con ognuno dei sistemi di fissaggio per realizzare configurazioni originali e flessibili ad ogni contesto.

*Levante 2.0 is a modular and combinable system. The designer can combine any light distribution with each of the fixing systems to create original and flexible configurations for any context.

Levante 2.0
Wall



X-SMALL

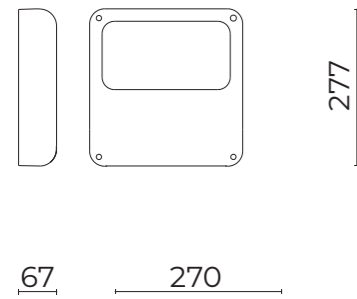

SMALL

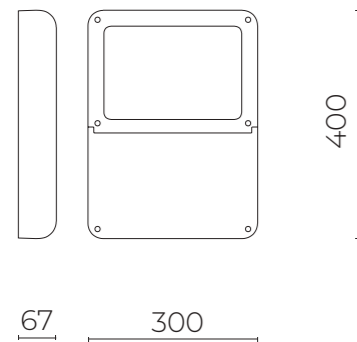

MEDIUM

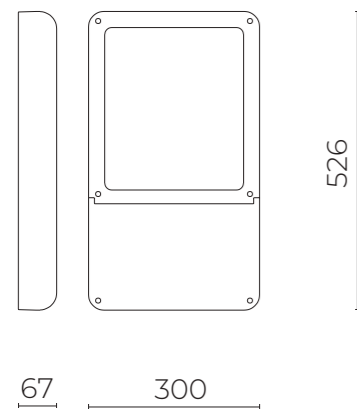

DATI TECNICI / TECHNICAL DATA

Installazione / Installation:
parete / wall

Orientabilità / Orientability:
con giunto inclinazione $\pm 90^\circ$, rotazione $\pm 15^\circ$
with joint tilt $\pm 90^\circ$, rotation $\pm 15^\circ$

ACCESSORI / ACCESSORIES

06LN900CO
B224 - Staffa fissa
Fixed bracket

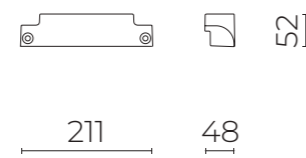

06LN901CO
B225 - Giunto orientabile
Adjustable joint

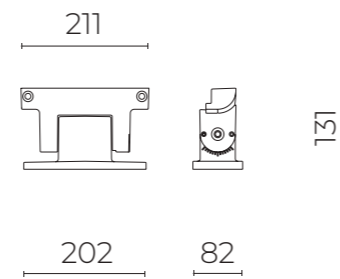

Levante 2.0
Flood

X-SMALL

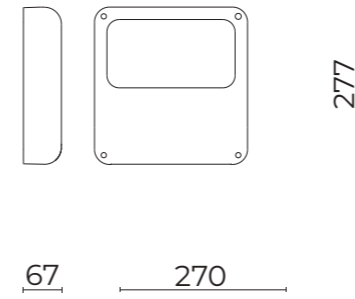

SMALL

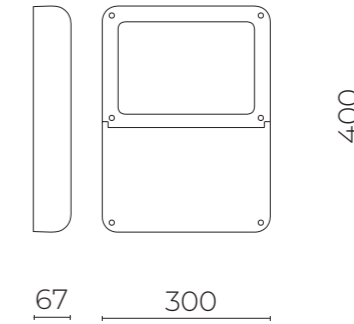

MEDIUM

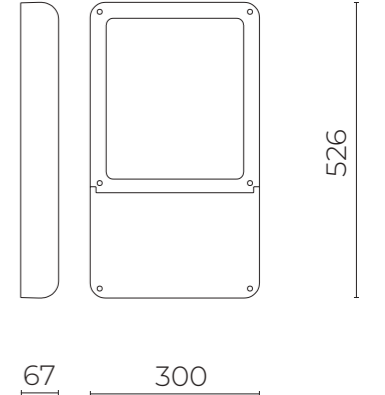

DATI TECNICI / TECHNICAL DATA

Installazione / Installation:
soffitto, terra / ceiling, ground

Orientabilità / Orientability:
con giunto inclinazione $\pm 90^\circ$, rotazione $\pm 15^\circ$
with joint tilt $\pm 90^\circ$, rotation $\pm 15^\circ$

ACCESSORI / ACCESSORIES

06LN901CO
B225 - Giunto orientabile
Adjustable joint

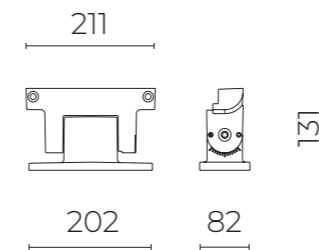

06LT909JO
B118 - Ancore per calcestruzzo
Anchor for concrete

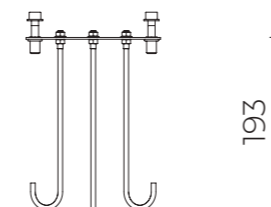

Levante 2.0
Poles

DATI TECNICI / TECHNICAL DATA

Installazione / Installation:
palo Ø 60 - 76 - 102 mm
pole Ø 60 - 76 - 102 mm

X-SMALL

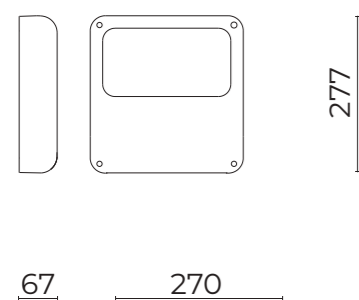

SMALL

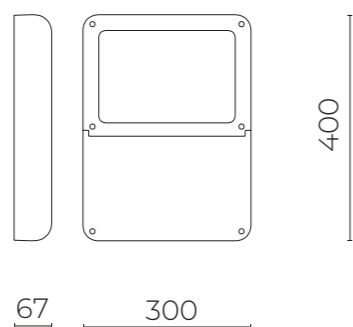

MEDIUM

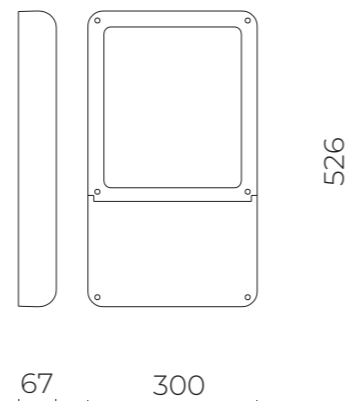

ACCESSORI / ACCESSORIES

06LN910C0
B237 - Giunto testa palo, codolo H 90 mm
Joint post top, fastening part H 90 mm

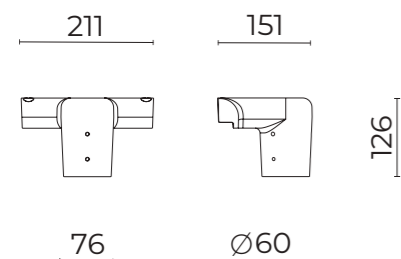

Levante 2.0
Poles



Levante 2.0

Poles

ACCESSORI / ACCESSORIES

06LN902C0 - Sablè 100 Noir

B226 - Collare singolo per pali Ø 60 mm
Single collar for poles Ø 60 mm

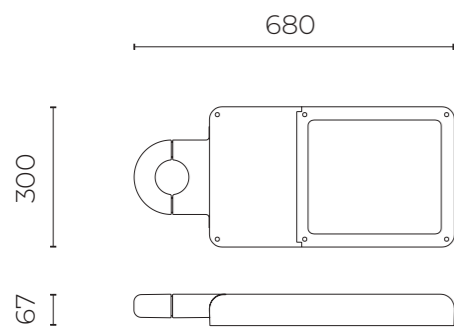
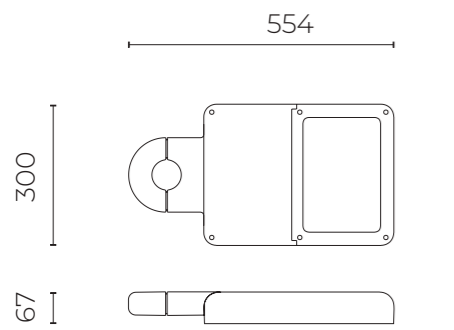

06LN905C0 - Sablè 100 Noir

B229 - Collare doppio per pali Ø 60 mm
Double collar for poles Ø 60 mm

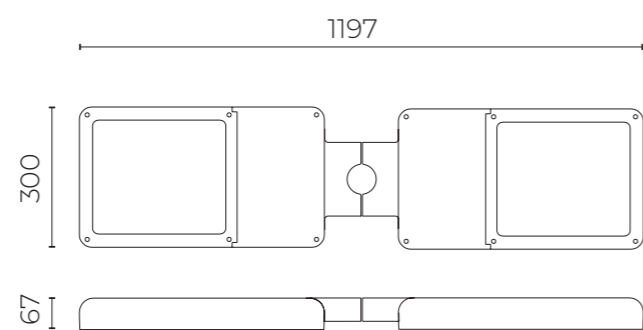
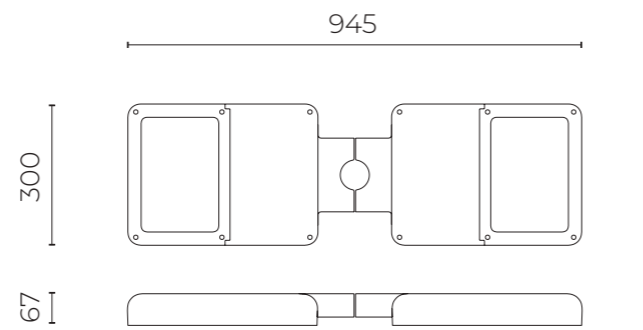

06LN903C0 - Sablè 100 Noir

B227 - Collare singolo per pali Ø 76 mm
Single collar for poles Ø 76 mm

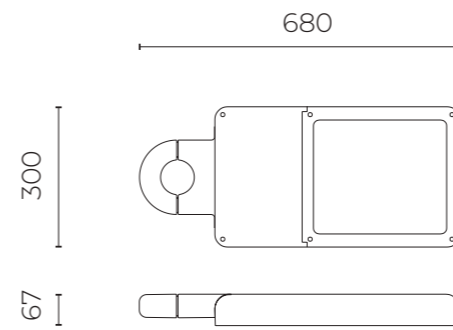
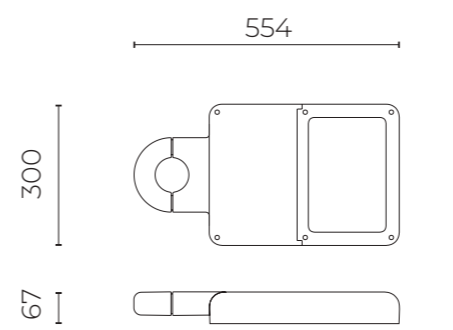

06LN906C0 - Sablè 100 Noir

B230 - Collare doppio per pali Ø 76 mm
Double collar for poles Ø 76 mm

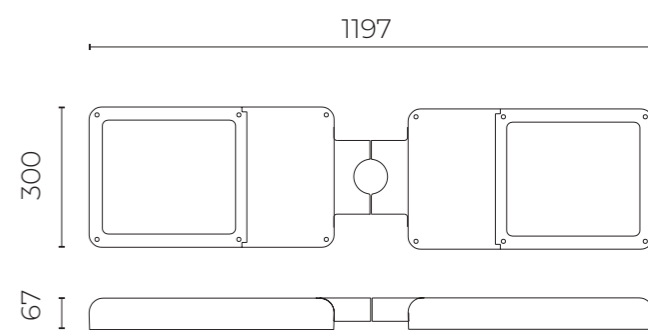
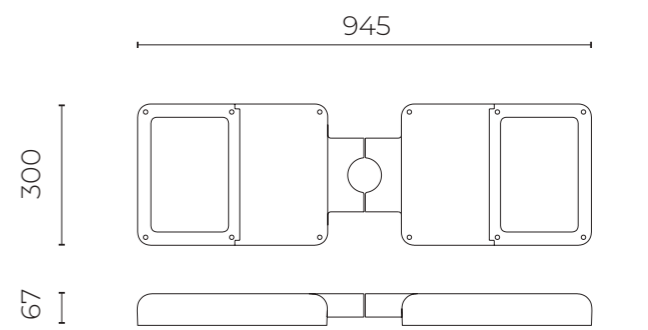

06LN904C0 - Sablè 100 Noir

B228 - Collare singolo per pali Ø 102 mm
Single collar for poles Ø 102 mm

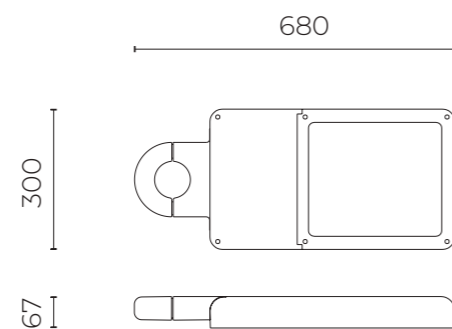
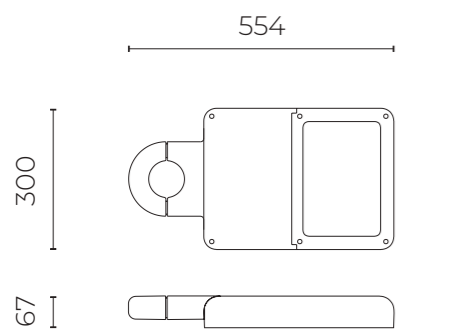

06LN907C0 - Sablè 100 Noir

B231 - Collare doppio per pali Ø 102 mm
Double collar for poles Ø 102 mm

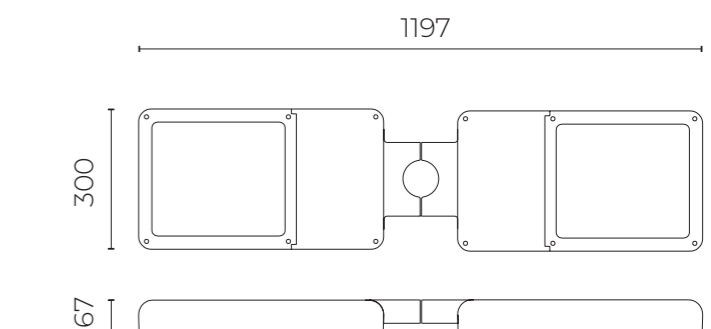
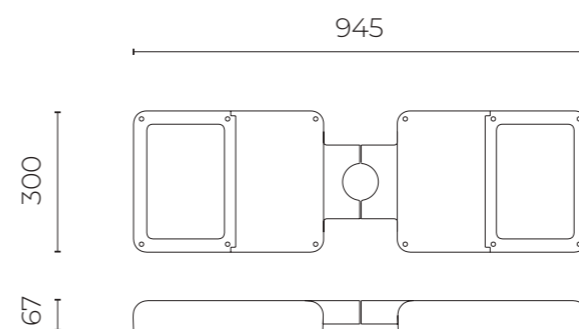

Levante 2.0

Brackets & poles

DATI TECNICI / TECHNICAL DATA

Installazione / Installation:

palo Ø 60 - 76 - 102 mm

pole Ø 60 - 76 - 102 mm

Orientabilità / Orientability:

con giunto inclinazione -70° ÷ +90°, rotazione 0° / 180°

with joint tilt -70° ÷ +90°; rotation 0° / 180°



X-SMALL

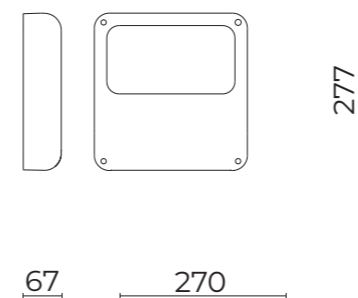

SMALL

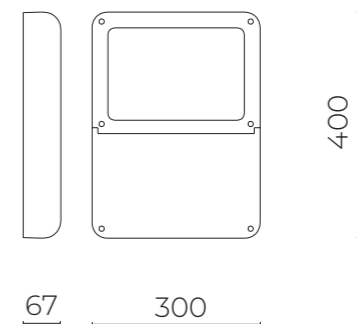

MEDIUM

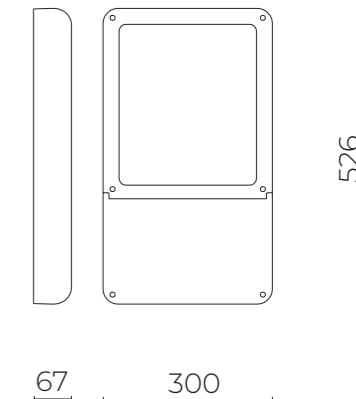

ACCESSORI / ACCESSORIES

06LN908CO - Sablè 100 Noir

B232 - Giunto orientabile per bracci e pali Ø 60 mm

Adjustable joint for arms and poles Ø 60 mm

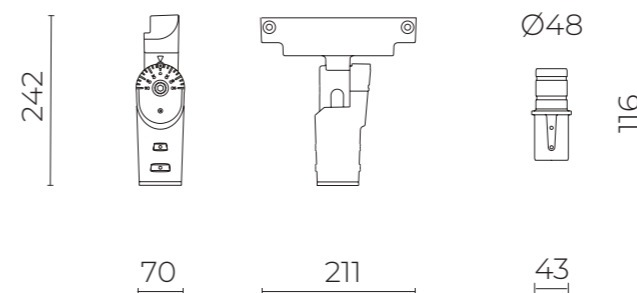

Levante 2.0

Brackets & poles

ACCESSORI E BRACCI / ACCESSORIES AND ARMS:

06AK903C0 - Sablè 100 Noir
L3 - Kit giunto per pali
 Joint kit for poles

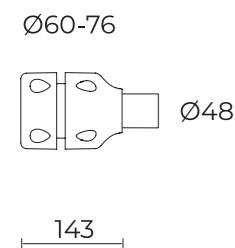

06AK904C0 - Sablè 100 Noir
L4 - Kit giunto doppio per pali
 Double joint kit for poles

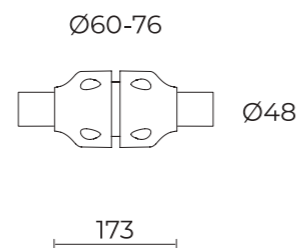

06AK921C0 - Sablè 100 Noir
B1 - Braccio per pali
 Arm for poles

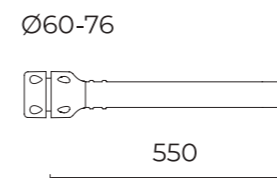

06AK922C0 - Sablè 100 Noir
B2 - Braccio doppio per pali
 Double arm for poles

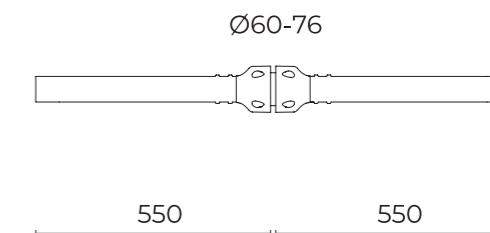

06AK916C0 - Sablè 100 Noir
B139 - Anello per pali
 Ring for poles

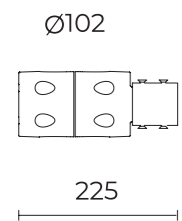

06AK917C0 - Sablè 100 Noir
B140 - Anello doppio per pali
 Double ring for poles

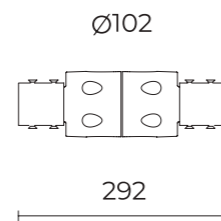

06AK907C0 - Sablè 100 Noir
B155 - Braccio per pali
 Arm for poles

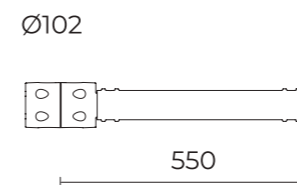

06AK909C0 - Sablè 100 Noir
B157 - Braccio doppio per pali
 Double arm for poles

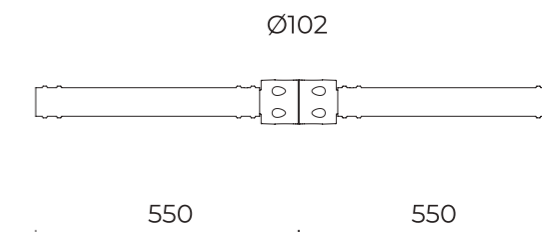

Levante 2.0

String suspension

SMALL

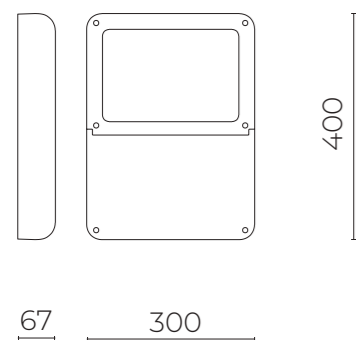

DATI TECNICI / TECHNICAL DATA

Installazione / Installation:
sospensione tesata / string suspension

Inclinazione / Inclination:
orizzontale $\pm 15^\circ$ / horizontal $\pm 15^\circ$

Orientabilità / Adjustability:
 $0^\circ \div 360^\circ$

ACCESSORI / ACCESSORIES

06LN909C0
B233 - Kit sospensione su fune tesata \varnothing 6-12 mm
Suspension kit for string \varnothing 6-12 mm

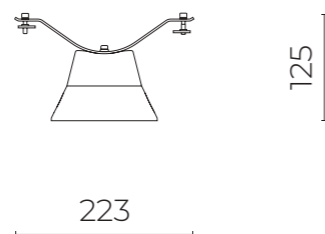

Levante 2.0

String suspension



KINETIC

Ogni luogo è diverso ed ogni luogo merita la propria luce: KINETIC è una soluzione professionale ed estremamente flessibile che offre nuovi modi di raccontare la città e le sue architetture.

Every place is different and deserves its own light: KINETIC is a professional and extremely flexible solution that offers new ways of telling the story of the city and its architecture.





MONOEMISSION

BIEMISSION

CEILING



CEILING



WALL

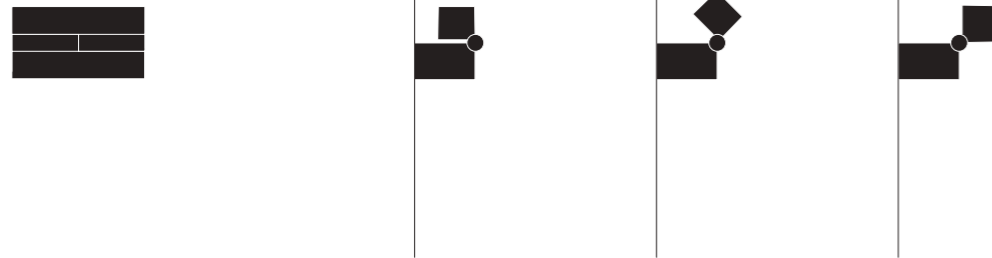

WALL

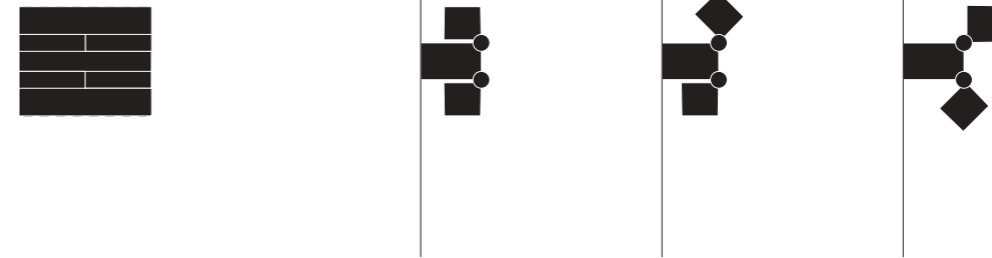

GROUND



GROUND



220-240V
24VDC (RGBW / TW)50
60Hz

CL II

IP65

IK07

ta
-30°C
+40°C

DATI PRESTAZIONALI / PERFORMANCE DATA





Flusso apparecchio / Fitting flux:
440 - 3320 lm

Potenza apparecchio / Fitting power:
18 - 38 W

Indice di resa cromatica / Colour Rendering Index:
CRI ≥ 90, SMCD ≤ 2 (2700 K)
CRI ≥ 80, SMCD ≤ 3

Illuminazione intelligente / Smart lighting:
DALI

TEMPERATURA COLORE
COLOUR TEMPERATURE

-  2200 K
-  2700 K
-  3000 K
-  4000 K
-  RGB+W 3000 K
-  TUNABLE WHITE 2200 K ÷ 4000 K

MATERIALI / MATERIALS



Corpo e sistemi di fissaggio / Body and fitting system:
pressofusione di lega d'alluminio UNI EN AB 47100
(contenuto rame < 1%) / die-cast aluminium alloy UNI EN
AB 47100 (copper content < 1%)

Schermo / Screen:
vetro piano temprato / tempered flat glass

Gruppo ottico / Optical unit:
lenti PMMA ad alta trasparenza
PMMA high transparent lenses

Finitura / Finish:
fosfocromatazione e verniciatura in polveri di poliestere
realizzata in 16 fasi per la miglior resistenza agli
agenti atmosferici / phospho-chromatation treated
and polyester powder-coated in 16 phases to increase
weather resistance

COLORI / COLOURS

-  SABLÉ 100 NOIR
-  CORTEN
-  RAL9003



CARATTERISTICHE / FEATURES

Peso massimo / Max weight:
5 kg (mono-emissione), 6,5 kg (bi-emissione)
5 kg (mono-emission), 6,5 kg (bi-emission)

Alimentazione elettronica / Electronic power supply:
inclusa (versioni ON-OFF, DALI), esclusa (versioni RGBW,
TW) / internal (ON-OFF, DALI versions), external (RGBW, TW
versions)

Installazione / Installation:
parete, soffitto, terra. Disponibile su richiesta distanziale per
ingresso cavo laterale / wall, ceiling, ground. A space for side
access power cable is available on request

Fissaggio / Fixing system:
con tasselli
with plugs

OTTICHE / OPTICS

PROJECTION LIGHT

M 18" Medium Beam



D 40° Wide Beam



U-D 70° Diffused Beam



GRAZING LIGHTING

18° Medium Beam



30°x 18° Medium Beam



60°x 18° Wide Beam



ASYMMETRICAL LIGHTING

AS-D 90°x 45° Asymmetric Beam



E 12°x50° Ellipsoidal Beam



* Le ottiche sono combinabili per le versioni bi-emissione.

* The optics are combinable for bi-emission versions.

Kinetic Wall

DATI TECNICI / TECHNICAL DATA

Installazione / Installation:
parete / wall

Inclinazione / Inclination:
-5° ÷ +165°



Kinetic Ceiling

DATI TECNICI / TECHNICAL DATA

Installazione / Installation:
soffitto / ceiling

Inclinazione / Inclination:
-5° ÷ +165°



Kinetic Flood

DATI TECNICI / TECHNICAL DATA

Installazione / Installation:
terra / ground

Inclinazione / Inclination:
-5° ÷ +165°

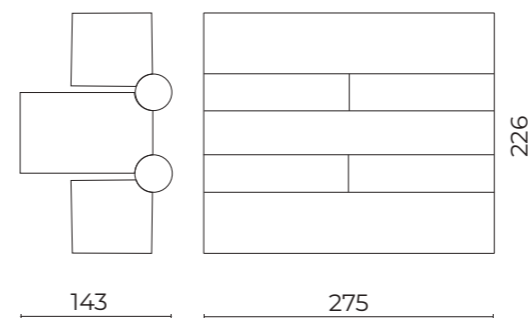
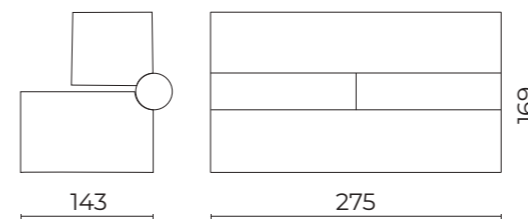

CUBE

CUBE è un prodotto compatto, ideale per l'illuminazione d'accento e diffusa di facciate, portici e ingressi agli edifici. Può essere utilizzato all'esterno e in ambienti interni particolarmente umidi.

CUBE is a compact product, ideal for accent and diffuse lighting of facades, porticos and building entrances. It can be used outdoors and in particularly damp indoor environments.



OMEGNA
Italy



220 240V	50 60Hz	CL I	IP65	IK06	ta -30°C +50°C
-------------	------------	------	------	------	----------------------



DATI PRESTAZIONALI / PERFORMANCE DATA

Flusso apparecchio / Fitting flux:
390 - 1120 lm

Potenza apparecchio / Fitting power:
7 - 16 W

Indice di resa cromatica / Colour Rendering Index:
CRI ≥ 80, SDCM ≤ 3

TEMPERATURA COLORE COLOUR TEMPERATURE

-  3000 K
-  4000 K

CARATTERISTICHE / FEATURES

Peso massimo / Max weight:
1,5 kg (small), 3 kg (medium)

Alimentazione elettronica / Electronic power supply:
inclusa / included

Installazione / Installation:
parete, soffitto, terra
wall, ceiling, ground

Fissaggio / Fixing system:
staffa fissa o regolabile
fixed or adjustable bracket

MATERIALI / MATERIALS

Corpo / Body:
pressofusione di lega d'alluminio UNI EN AB 47100
(contenuto rame < 1%) / die-cast aluminium alloy UNI EN
AB 47100 (copper content < 1%)

Schermo / Screen:
vetro piano temprato / tempered flat glass

Gruppo ottico / Optical unit:
lenti PMMA ad alta trasparenza
high-transparency PMMA lenses

Finitura / Finish:
fosfocromatazione e verniciatura in polveri di poliestere
realizzata in 16 fasi per la miglior resistenza agli
agenti atmosferici / phospho-chromatation treated
and polyester powder-coated in 16 phases to increase
weather resistance

COLORI / COLOURS

-  SABLÉ 100 NOIR
-  RAL9006
-  RAL9003



OTTICHE / OPTICS

C 8° Narrow Beam

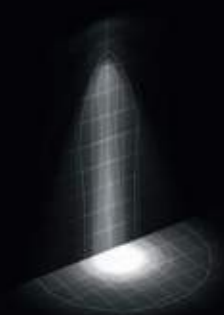

U-D 80° Diffused Beam

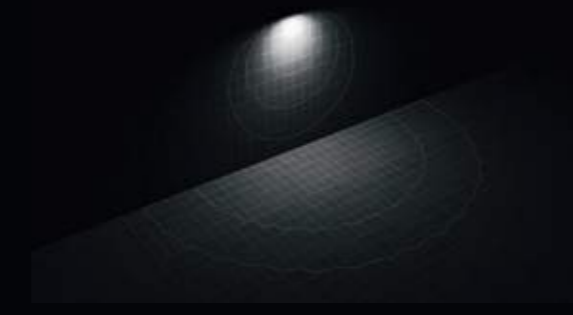

D 40° Wide Beam



Cube
Parete / Wall

SMALL

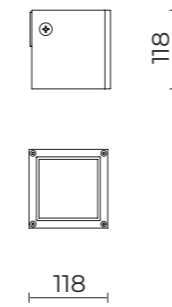

MEDIUM

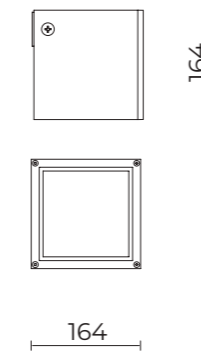

ACCESSORI / ACCESSORIES

06LC1901A - RAL9006
06LC1901C - Sablé 100
06LC1901D - RAL9003
Snodo per fissaggio a parete Cube small
Joint for wall-mounting Cube small

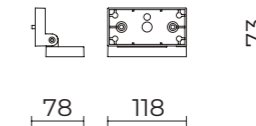

06LC2901A - RAL9006
06LC2901C - Sablé 100
06LC2901D - RAL9003
Snodo per fissaggio a parete Cube medium
Joint for wall-mounting Cube medium

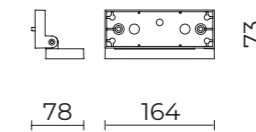

OTTICHE / OPTICS

C 8° Narrow Beam



U-D 80° Diffused Beam



D 40° Wide Beam



Cube
Soffitto / Ceiling



SMALL

MEDIUM

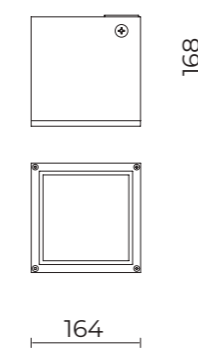
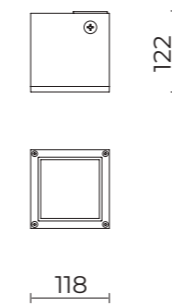

ACCESSORI / ACCESSORIES

06LC1901A - RAL9006
06LC1901C - Sablé 100
06LC1901D - RAL9003
Snodo per fissaggio a parete Cube small
Joint for wall-mounting Cube small

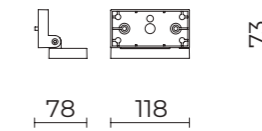

06LC2901A - RAL9006
06LC2901C - Sablé 100
06LC2901D - RAL9003
Snodo per fissaggio a parete Cube medium
Joint for wall-mounting Cube medium

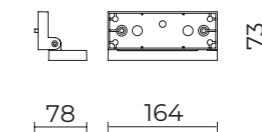

C 8° Narrow Beam

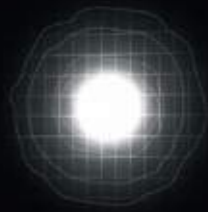

U-D 80° Diffused Beam



D 40° Wide Beam



Cube
Terra / Ground

SMALL

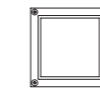

118

MEDIUM

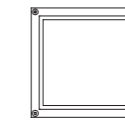
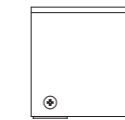

164

ACCESSORI / ACCESSORIES

06LC1901A - RAL9006
06LC1901C - Sablé 100
06LC1901D - RAL9003
Snodo per fissaggio a parete Cube small
 Joint for wall-mounting Cube small

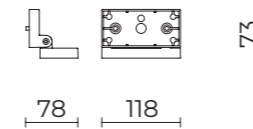

06LC2901A - RAL9006
06LC2901C - Sablé 100
06LC2901D - RAL9003
Snodo per fissaggio a parete Cube medium
 Joint for wall-mounting Cube medium

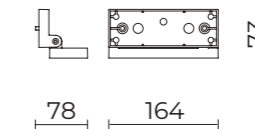

06LC900C0 - Sablé 100 (Cube small)
06LC901C0 - Sablé 100 (Cube medium)
Picchetto per interrimento
 Spike for ground installation

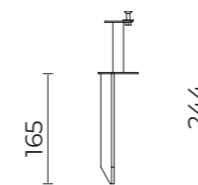

CHARA

CHARA è un prodotto da incasso dalle dimensioni compatte, ideale per l'illuminazione d'accento di facciate e di ambienti interni particolarmente umidi.

CHARA is a compact recessed fitting, ideal for accent lighting of facades and particularly damp interiors.



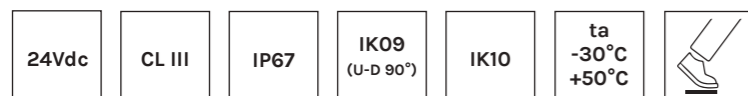

DATI PRESTAZIONALI / PERFORMANCE DATA



Flusso apparecchio / Fitting flux:
67 - 295 lm

Potenza apparecchio / Fitting power:
0,6 - 3,2 W

Indice di resa cromatica / Colour Rendering Index:
CRI ≥ 80, SDCM ≤ 3

Illuminazione intelligente / Smart lighting:
DALI su richiesta / DALI on request

TEMPERATURA COLORE COLOUR TEMPERATURE

-  2700 K
-  3000 K
-  4000 K

MATERIALI / MATERIALS

Corpo / Body:
acciaio INOX AISI 316L micropallinato con finitura
sabbata / micro-shot peened stainless steel INOX AISI
316L with sandblasted finish

Schermo / Screen:
vetro piano temprato / tempered flat glass

Gruppo ottico / Optical unit:
lenti PMMA ad alta trasparenza
high-transparency PMMA lenses

Finitura / Finish:
cornice INOX AISI 316L con finitura sabbata
e micropallinata con sfere di vetro / AISI 316L stainless
steel frame with sandblasted and micro-shot glass-
sphere peened finish

COLORI / COLOURS

-  INOX AISI 316L

CARATTERISTICHE / FEATURES

Peso massimo / Max weight:
0,4 kg

Alimentazione elettronica / Electronic power supply:
esterna, da ordinare separatamente
external, to be ordered separately

Precablaggio / Pre-wiring:
prodotto pre-cablato, lunghezza cavo 1 m
pre-wired product, cable length of 1 m

Installazione / Installation:
terra (calpestabile), pavimento flottante, parete,
controsoffitto / ground (walk over), floating floor,
wall, false ceiling

Fissaggio / Fixing system:
con controcassa in materiale plastico (versione incasso
calpestabile, parete), con molle (versione incasso soffitto)
with plastic housing (walk over, wall recessed versions),
with steel springs (ceiling-recessed version)



OTTICHE / OPTICS

C 8° Narrow Beam

M 25° Medium Beam



U-D 90° Diffused Beam

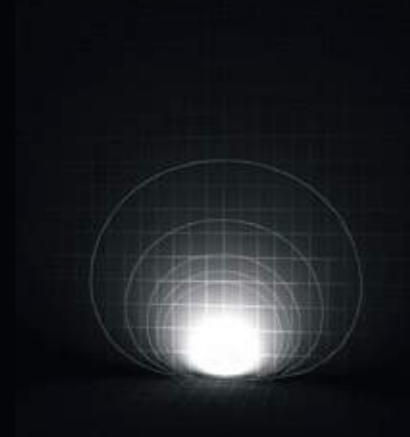

Chara

Incasso calpestabile
Walk over recessed

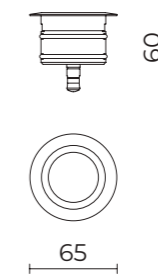

ACCESSORI / ACCESSORIES

06CH901B0
B130 - Controcassa
parete e calpestabile
Walk over and wall
recessed housing

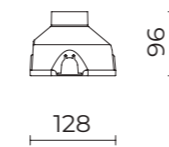

06CH906X0
B198 - Kit entra-esce cavo 1 m
24V ~ con muffola / Kit in-out
cable 1 m 24V ~ with junction box

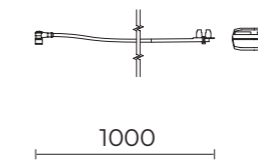

06CH903X0
B147 - Driver elettronico
10W 24V IP67
Electronic driver
10W 24V IP67

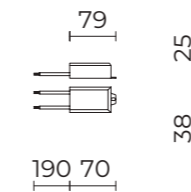

06CH904X0
B148 - Driver elettronico
60W 24V IP67
Electronic driver
60W 24V IP67

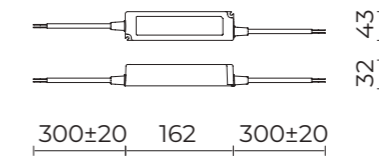

06LL914AB0
Driver elettronico DALI
150W 24V IP67
DALI electronic driver
150W 24V IP67



06KS918C0
B137 - Connettore 2 vie IP68
2-way connector IP68

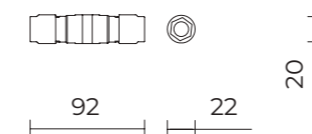

06KS909C0
B89 - Connettore 4 vie IP68
4-way connector IP68

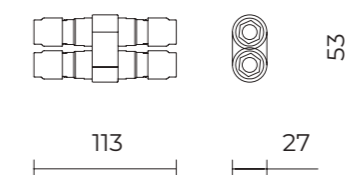

OTTICHE / OPTICS

C 8° Narrow Beam

M 25° Medium Beam



U-D 90° Diffused Beam



Chara

Incasso parete
Wall recessed

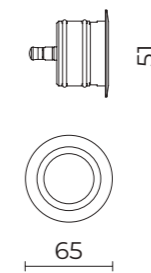

ACCESSORI / ACCESSORIES

06CH901B0
B130 - Controcassa
parete e calpestabile
Walk over and wall
recessed housing

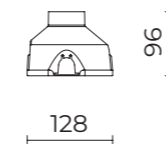

06CH906X0
B198 - Kit entra-esce cavo 1 m
24V ~ con muffola / Kit in-out
cable 1 m 24V ~ with junction box

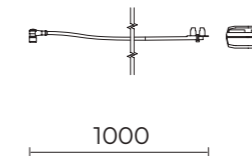

06CH903X0
B147 - Driver elettronico
10W 24V IP67
Electronic driver
10W 24V IP67

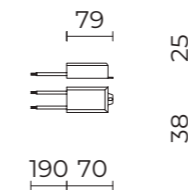

06CH904X0
B148 - Driver elettronico
60W 24V IP67
Electronic driver
60W 24V IP67

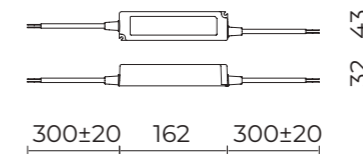

06LL914AB0
Driver elettronico
DALI 150W 24V IP67
DALI electronic driver
150W 24V IP67



06KS918C0
B137 - Connettore 2 vie IP68
2-way connector IP68

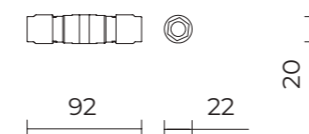

06KS909C0
B89 - Connettore 4 vie IP68
4-way connector IP68

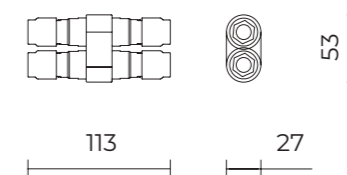

OTTICHE / OPTICS

C 8° Narrow Beam



M 25° Medium Beam



U-D 90° Diffused Beam

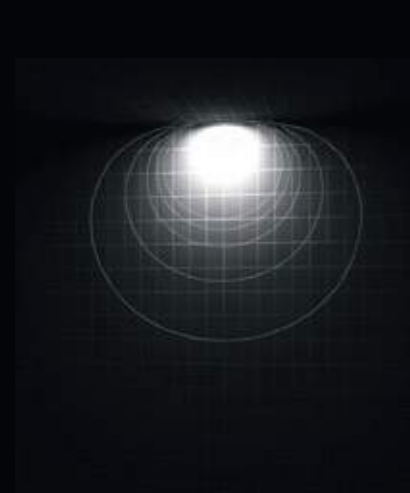

Chara

Incasso soffitto
Ceiling recessed

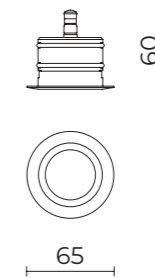

ACCESSORI / ACCESSORIES

06CH902XX0
B131 - Molle
Springs

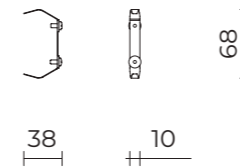

06CH906X0
B198 - Kit entra-esce cavo 1 m
24V ~ con muffola / Kit in-out
cable 1 m 24V ~ with junction box

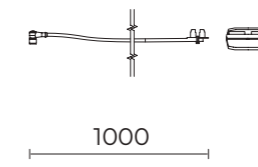

06CH903X0
B147 - Driver elettronico
10W 24V IP67
Electronic driver
10W 24V IP67

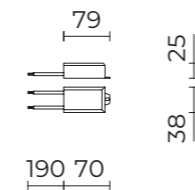

06CH904X0
B148 - Driver elettronico
60W 24V IP67
Electronic driver
60W 24V IP67

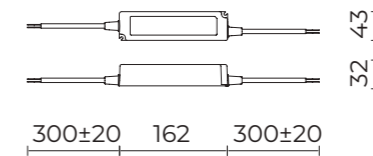

06LL914AB0
Driver elettronico DALI
150W 24V IP67
DALI electronic driver
150W 24V IP67



06KS918C0
B137 - Connettore 2 vie IP68
2-way connector IP68

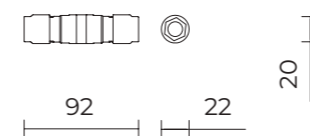

06KS909C0
B89 - Connettore 4 vie IP68
4-way connector IP68

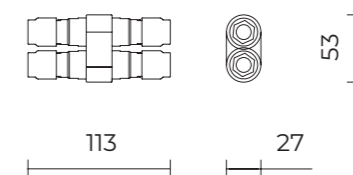

GRACE

GRACE è la soluzione, compatta ed elegante,
per l'illuminazione radente di aree
e percorsi pedonali.

GRACE is a compact and elegant solution for
grazing light in pedestrian areas and pathways.





DATI PRESTAZIONALI / PERFORMANCE DATA

Flusso apparecchio / Fitting flux:
105 - 340 lm

Potenza apparecchio / Fitting power:
2 - 5 W

Indice di resa cromatica / Colour Rendering Index:
CRI ≥ 80, SDCM ≤ 3

Illuminazione intelligente / Smart lighting:
DALI su richiesta / DALI on request

MATERIALI / MATERIALS

Corpo / Body:
acciaio AISI 316L micropallinato con finitura sabbata
micro-shot peened stainless steel AISI 316L
with sanded finish

Gruppo ottico / Optical unit:
lente TIR (Total Internal Reflection) realizzata in Ultra-Clear LSR (Liquid Silicone Rubber)
TIR (Total Internal Reflection) lense made from Ultra-Clear LSR (Liquid Silicone Rubber)

Finitura / Finish:
AISI 316L con finitura sabbata e micropallinata con sfere di vetro / AISI 316L stainless steel with sandblasted and micro-shot glass-sphere peened finish

TEMPERATURA COLORE COLOUR TEMPERATURE

-  3000 K
-  4000 K

COLORI / COLOURS

-  INOX AISI 316L

CARATTERISTICHE / FEATURES

Peso massimo / Max weight:
1 kg

Alimentazione elettronica / Electronic power supply:
esterna, da ordinare separatamente
external, to be ordered separately

Precablaggio / Pre-wiring:
incluso / included

Fissaggio / Fastening:
controcassa in materiale plastico da murare a pavimento (versione carrabile), con piastra in acciaio per fissaggio a terra o pavimento (versione calpestabile)
with recessed housing in plastic material to be buried in the floor (drive over version); with steel plate for ground or floor mounting (walk over version)

Installazione / Installation:
terra / ground





LOHJA
Finland

NERVI
Italy



OTTICHE / OPTICS

AS-D 180° Asymmetric Diffused Beam



RS-D 360° Rotosymmetric Diffused Beam

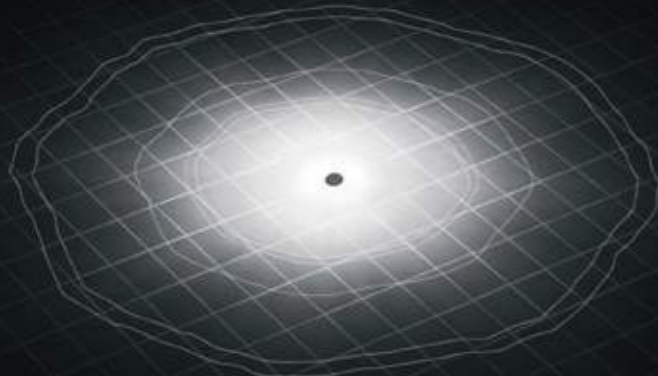

Grace

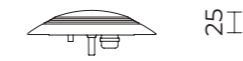

ACCESSORI / ACCESSORIES

06GC901B0
B129 - Controcassa carrabile
 Drive over recessed housing

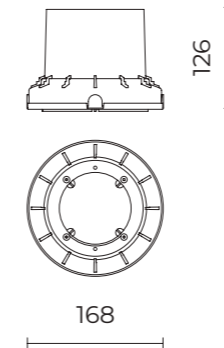

06GC902X0
B165 - Connettore 2 IP68 2-pole
 connector IP68

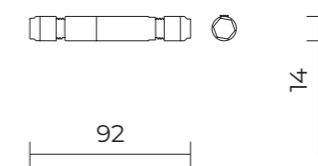

06AK958X0
M3 - Kit entra-esca cavo 2x0,75
 Kit in-out cable 2x0,75

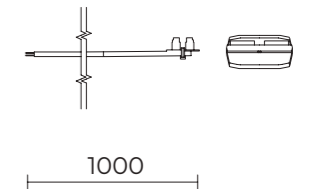

06CH903X0
B147 - Driver elettronico
10W 24V IP67
 Electronic driver
 10W 24V IP67

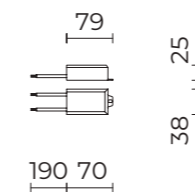

06CH904X0
B148 - Driver elettronico
60W 24V IP67
 Electronic driver
 60W 24V IP67

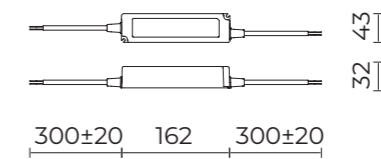

06LL914AB0
Driver elettronico DALI
150W 24V IP67
 DALI electronic driver
 150W 24V IP67



TRAIL

TRAIL è la soluzione ideale per l'illuminazione lineare outdoor e indoor di tutti quei luoghi dove è necessaria qualità della luce, affidabilità ed efficienza energetica.

TRAIL is the ideal solution for indoor and outdoor linear lighting wherever light quality, reliability and energy efficiency are required.

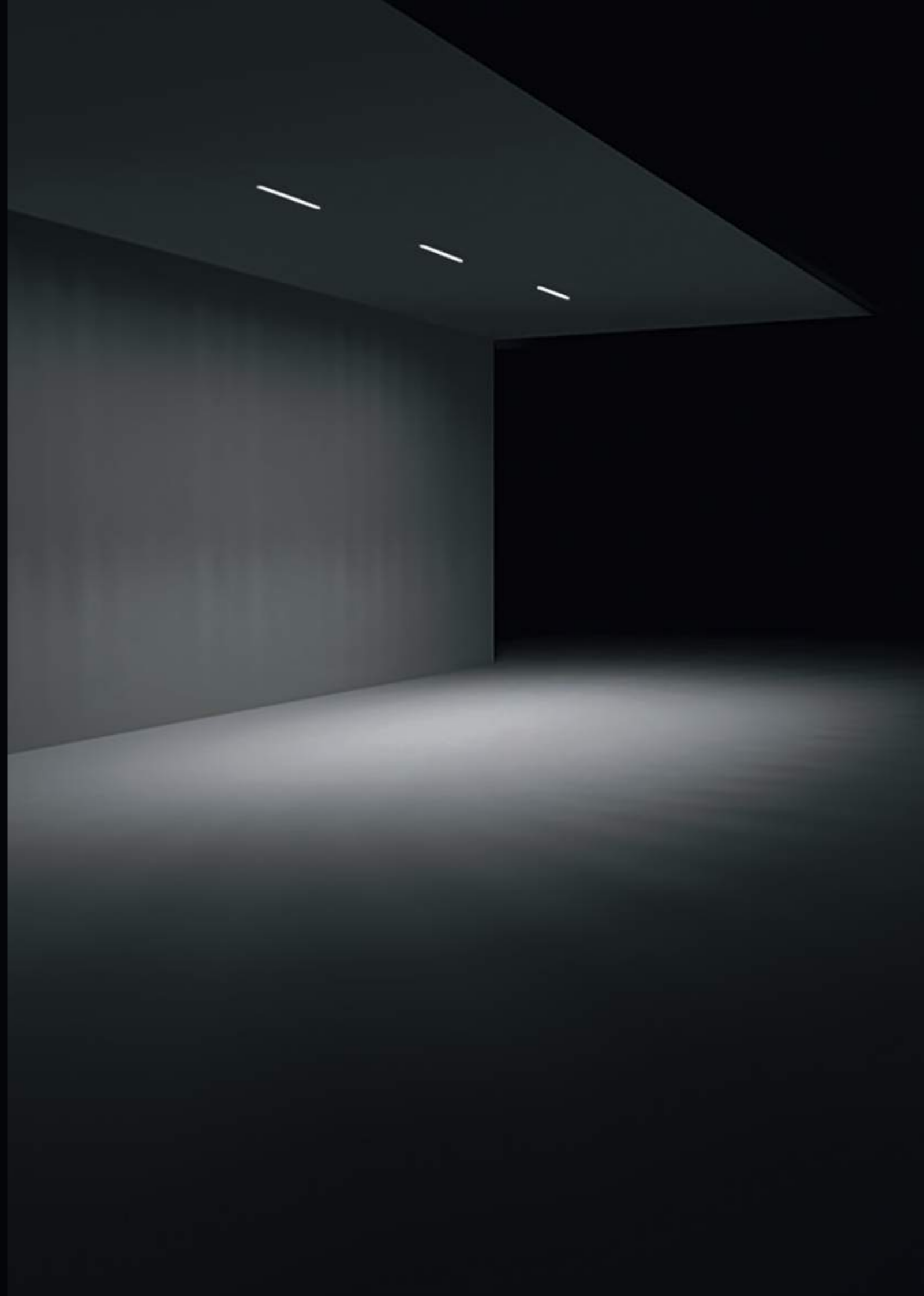



SPALATO
Croatia

OLBIA
Italy





DATI PRESTAZIONALI / PERFORMANCE DATA

Flusso apparecchio / Fitting flux:
795 - 7530 lm

Potenza apparecchio / Fitting power:
7,2 - 57,5 W

Indice di resa cromatica / Colour Rendering Index:
CRI ≥ 80, SDCM ≤ 3

Illuminazione intelligente / Smart lighting:
DALI su richiesta / DALI on request

MATERIALI / MATERIALS

Corpo / Body:
estruso in lega di alluminio anodizzato
extruded anodised aluminium alloy

Sistemi di fissaggio / Fitting system:
testate di chiusura e accessori di fissaggio in
pressofusione in lega di alluminio UNI EN AB 47100
(contenuto di rame < 1%) / closing heads and fastening
accessories made of die-cast aluminium alloy
UNI EN AB 47100 (copper content < 1%)

Schermo / Screen:
vetro piano temprato / tempered flat glass

Gruppo ottico / Optical unit:
lenti PMMA ad alta trasparenza
PMMA high transparent lenses

Finitura / Finish:
anodizzazione / anodization

TEMPERATURA COLORE COLOUR TEMPERATURE

- 3000 K
- 4000 K

COLORI / COLOURS

- ALLUMINIO ANODIZZATO
NATURALE / NATURAL
ANODIZED ALUMINIUM

CARATTERISTICHE / FEATURES

Peso massimo / Max weight:
3 kg (650 mm), 6 kg (1250 mm), 10 kg (2500 mm)

Alimentazione elettronica / Electronic power supply:
remota, da ordinare separatamente
remote, to be ordered separately

Precablaggio / Pre-wiring:
prodotto pre-cablato con cavo e connettore
pre-wired product with cable and connector

Installazione / Installation:
incasso soffitto, soffitto, incasso calpestabile,
incasso parete, parete, linea continua
recessed ceiling, ceiling, walkable recessed,
wall recessed, wall, continuous line



OTTICHE / OPTICS

U-D 80° / 100° Diffused Beam

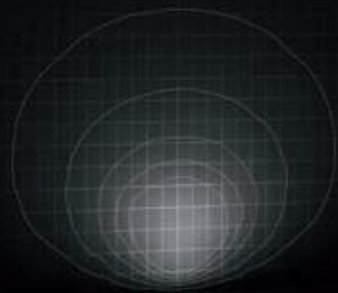

S 75° / 95° Ultra-Wide Beam



AS $\alpha=13^\circ$ 30° / 75° Asymmetric Beam



Trail

Incasso calpestabile / Walk over recessed

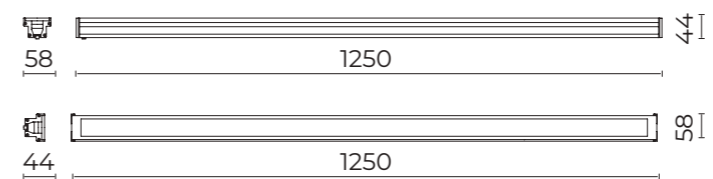
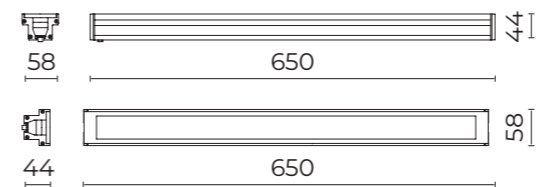



Trail

Incasso calpestabile / Walk over recessed

ACCESSORI / ACCESSORIES

06TR998J0
Controcassa Trail 650
Recessed housing Trail 650

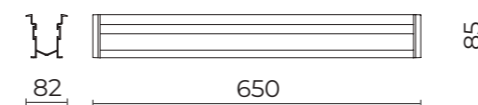

06TR999J0
Controcassa Trail 1250
Recessed housing Trail 1250

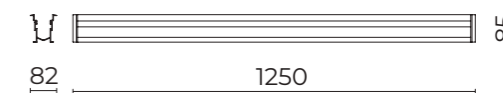

06TA902X0
Driver elettronico 60W 24V IP66
Electronic driver 60W 24V IP66

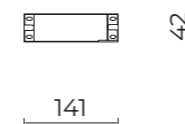

06LL914AB0
Driver elettronico DALI 150W 24V IP67
DALI electronic driver 150W 24V IP67

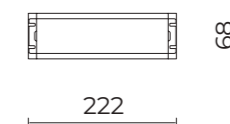

06LL915AB0
Driver elettronico 240W 24V IP67
Electronic driver 240W 24V IP67

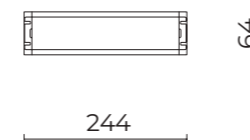

06AK958X0
M3 - Kit entra-esci cavo 2x0,75
Kit in-out cable 2x0,75

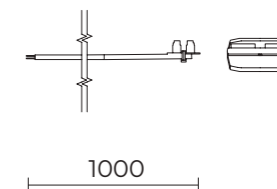

06GC902X0
B165 - Connettore 2 poli IP68
2-pole connector IP68

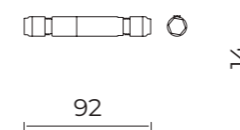

OTTICHE / OPTICS

U-D 80° / 100° Diffused Beam



S 75° / 95° Ultra-Wide Beam



AS α=13° 30° / 75° Asymmetric Beam



Trail

Incasso soffitto / Ceiling-recessed

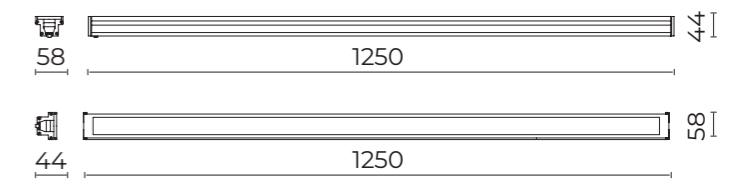
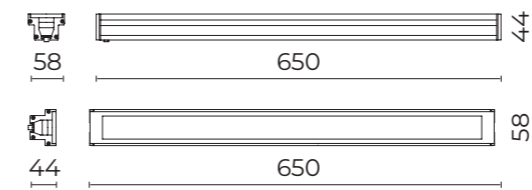

ACCESSORI / ACCESSORIES

06TR988A0
Kit incasso a plafone Trail 650
Recessed ceiling kit Trail 650

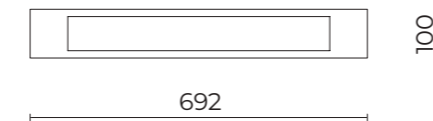

06TR989A0
Kit incasso a plafone Trail 1250
Recessed ceiling kit Trail 1250

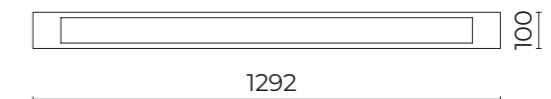

06TA902X0
Driver elettronico 60W 24V IP66
Electronic driver 60W 24V IP66

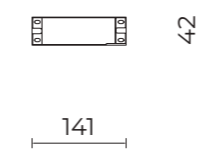

06LL914AB0
Driver elettronico DALI 150W 24V IP67
DALI electronic driver 150W 24V IP67

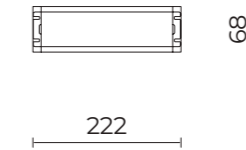

06LL915AB0
Driver elettronico 240W 24V IP67
Electronic driver 240W 24V IP67

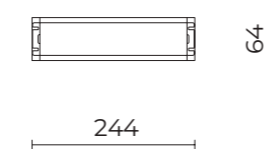

U-D 80° / 100° Diffused Beam

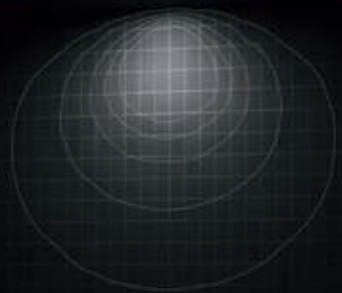

S 75° / 95° Ultra-Wide Beam



AS α=13° 30° / 75° Asymmetric Beam



Trail
Soffitto / Ceiling-mounted

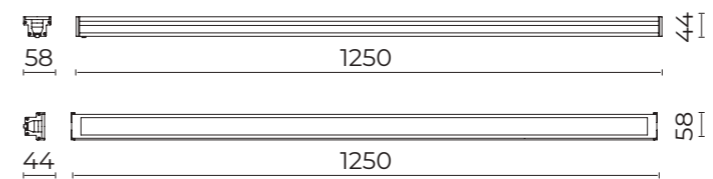
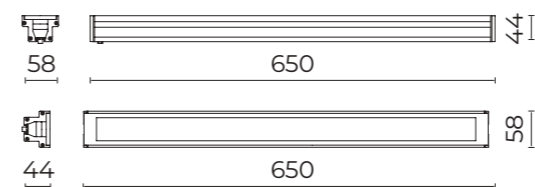
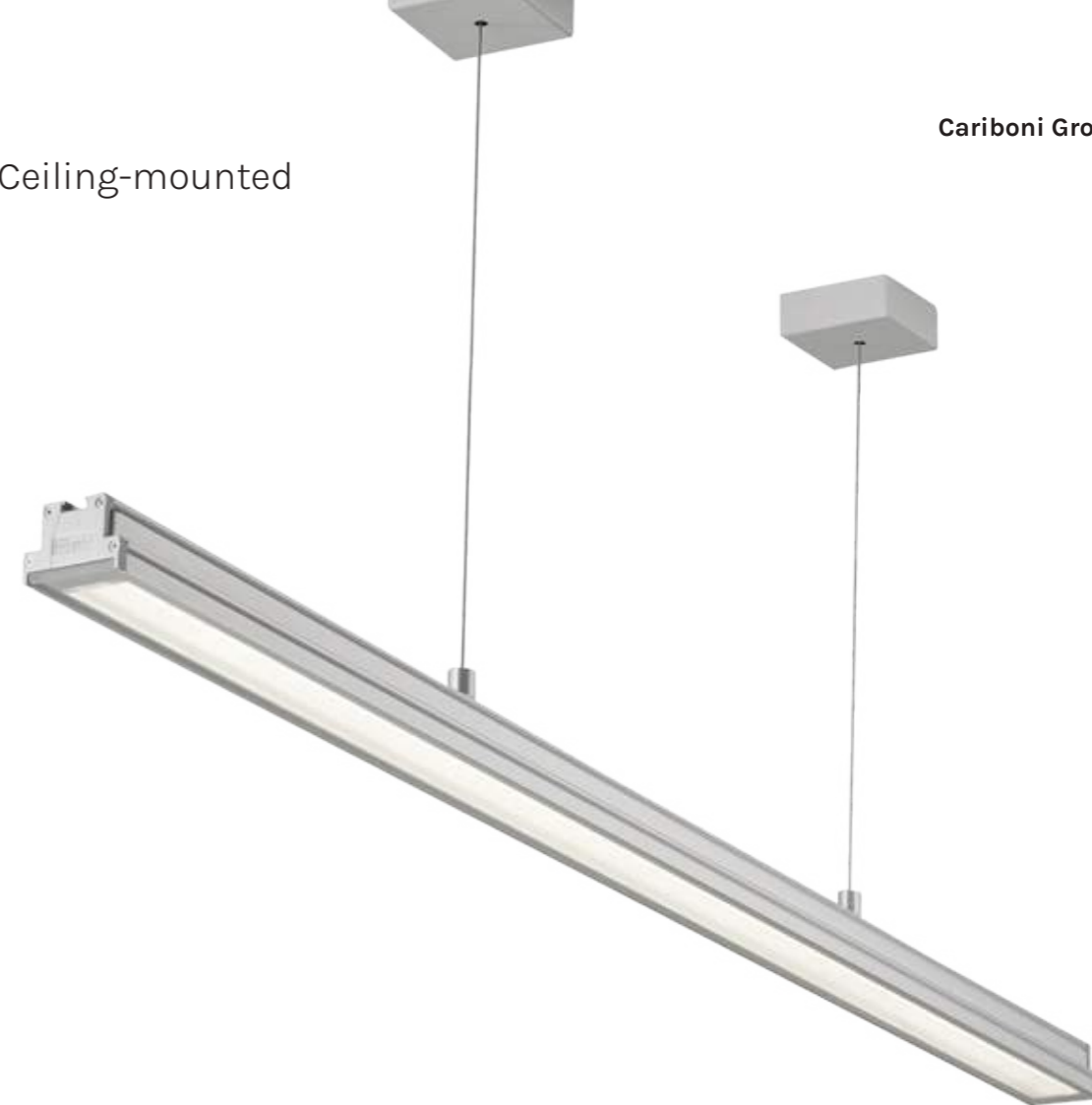

Trail

Soffitto / Ceiling-mounted

ACCESSORI / ACCESSORIES

06TR986A0

Sistema sospensione Trail a soffitto driver remoto

Trail ceiling suspension system remote driver

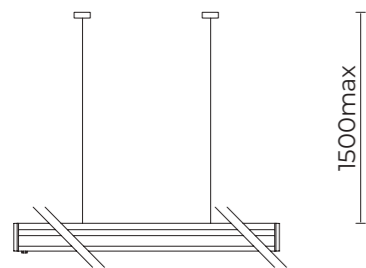

06TR987A0 - RAL9006

Staffe fissaggio Trail plafone driver remoto

Trail ceiling mounting brackets remote driver

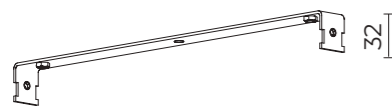

06LL914A0

Driver elettronico 150W 24V IP67

Electronic driver 150W 24V IP67

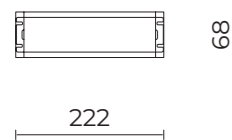

06GC902X0

B165 - Connettore 2 poli IP68

2-pole connector IP68

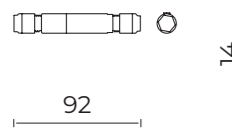

06OT988A0

Box cablato Trail per attacco a parete o a soffitto

IP65 CL II / Wired box Trail for wall or ceiling attachment IP65 CL II

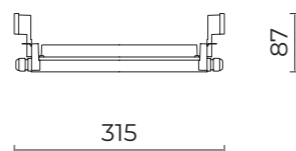

06TA902X0

Driver elettronico 60W 24V IP66

Electronic driver 60W 24V IP66

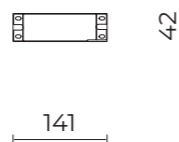

06LL915A0

Driver elettronico DALI 150W 24V IP67

DALI electronic driver 150W 24V IP67

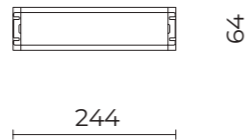

06TR977X0

B220 - Connettore 4 vie IP68

4-way connector IP68

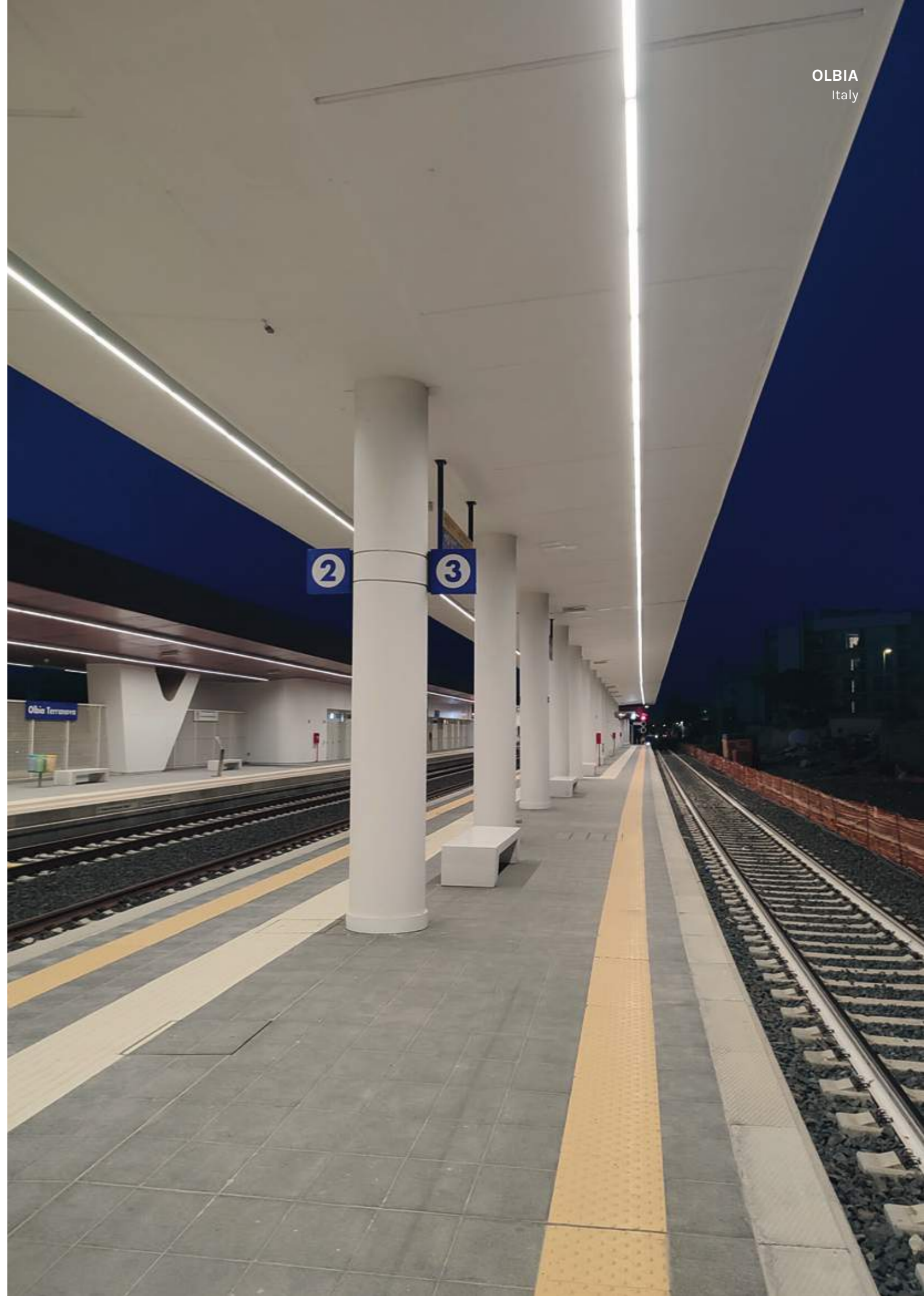
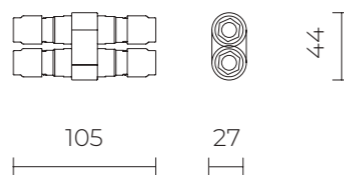

OTTICHE / OPTICS

U-D 80° / 100° Diffused Beam



S 75° / 95° Ultra-Wide Beam



AS $\alpha=13^\circ$ 30° / 75° Asymmetric Beam



Trail

Incasso parete / Wall-recessed

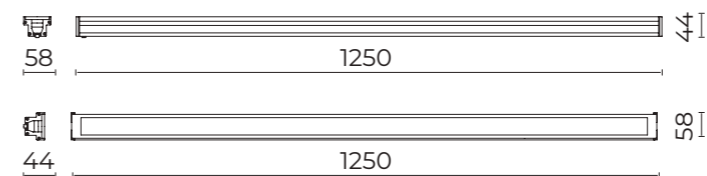
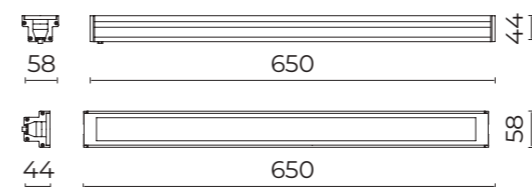

Trail

Trail

Incasso parete / Wall-recessed

ACCESSORI / ACCESSORIES

06TR998JO
Controcassa Trail 650
Recessed housing Trail 650

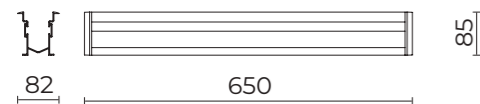

06TR999JO
Controcassa Trail 1250
Recessed housing Trail 1250

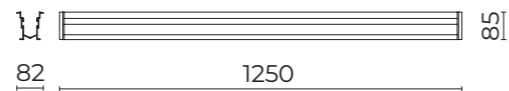

06TA902X0
Driver elettronico 60W 24V IP66
Electronic driver 60W 24V IP66

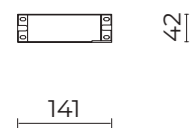

06LL914AB0
Driver elettronico DALI 150W 24V IP67
DALI electronic driver 150W 24V IP67



06LL915AB0
Driver elettronico 240W 24V IP67
Electronic driver 240W 24V IP67

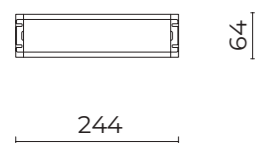

06AK958X0
M3 - Kit entra-esca cavo 2x0,75
Kit in-out cable 2x0,75

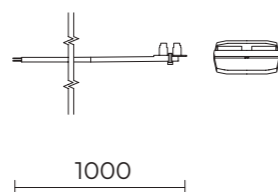

06GC902X0
B165 - Connettore 2 poli IP68
2-pole connector IP68

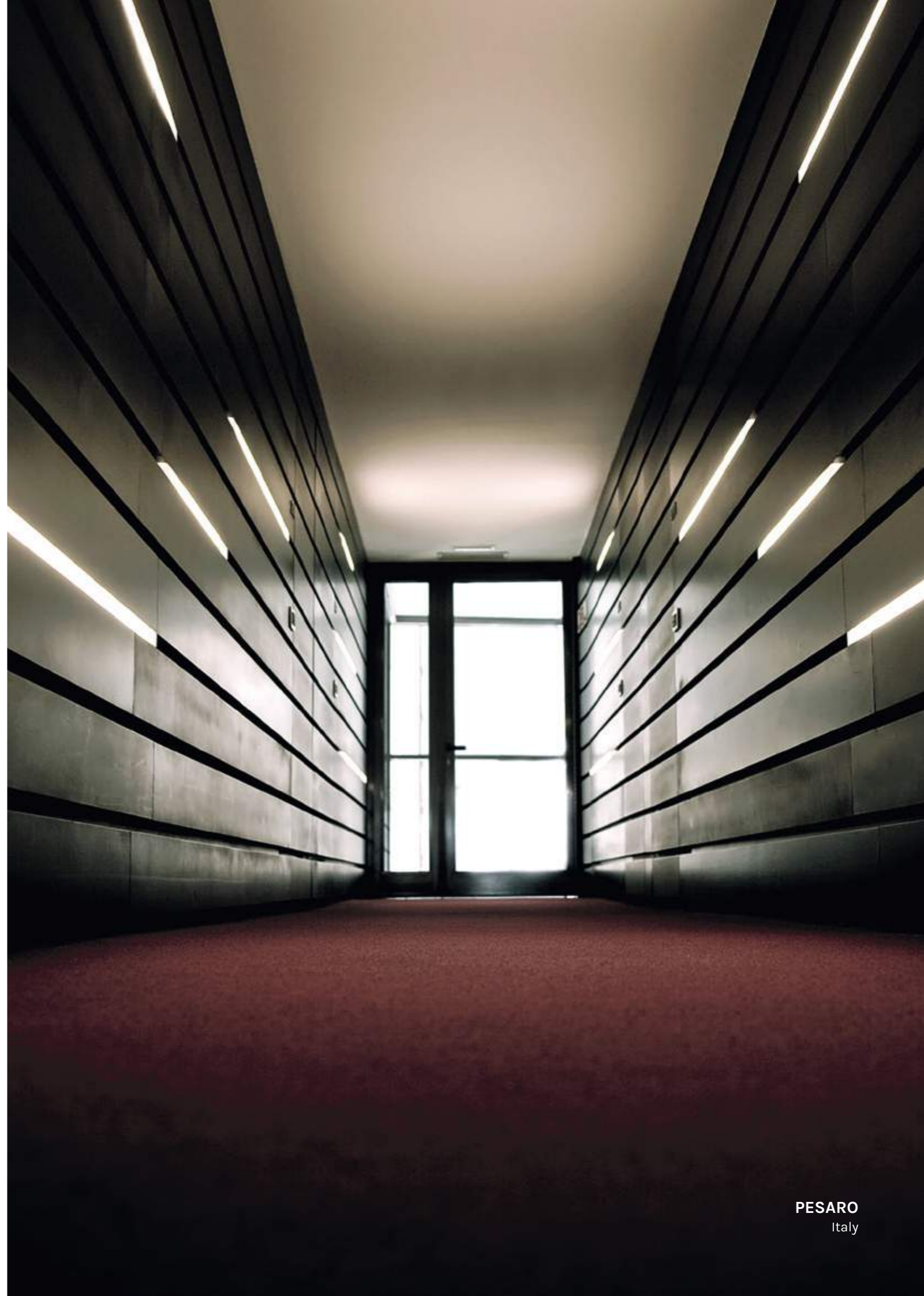
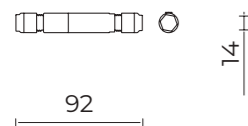

OTTICHE / OPTICS

U-D 80° / 100° Diffused Beam



S 75° / 95° Ultra-Wide Beam



AS $\alpha=13^\circ$ 30° / 75° Asymmetric Beam



Trail

Parete / Wall-mounted

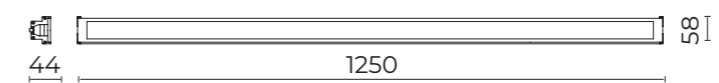
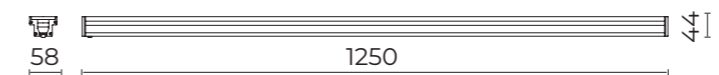
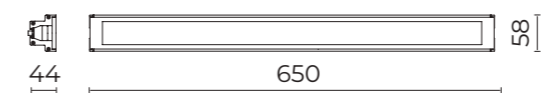
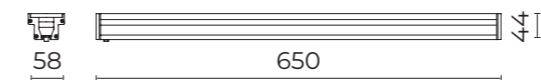



Trail

Parete / Wall-mounted

ACCESSORI / ACCESSORIES

06OT988A0

Box cablato per attacco a parete o a soffitto IP65 CL II
Wired box for wall or ceiling attachment IP65 CL II

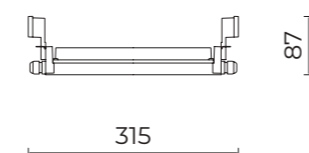

06TR997A0

Staffe fissaggio parete driver remoto
Wall mounting brackets, remote driver



06TA902X0

Driver elettronico 60W 24V IP66
Electronic driver 60W 24V IP66

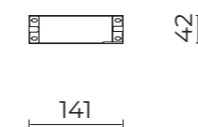

06LL914AB0

Driver elettronico DALI 150W 24V IP67
DALI electronic driver 150W 24V IP67

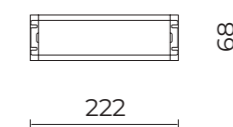

06LL915AB0

Driver elettronico 240W 24V IP67
Electronic driver 240W 24V IP67

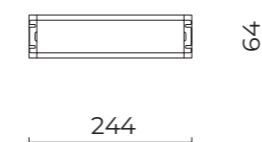

06GC902X0

B165 - Connettore 2 poli IP68
2-pole connector IP68

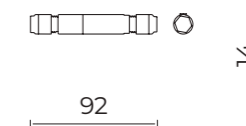

06TR977X0

B220 - Connettore 4 vie IP68
4-way connector IP68

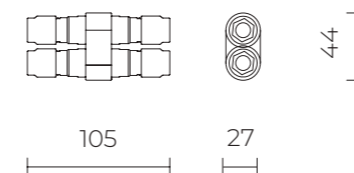

OTTICHE / OPTICS

U-D 80° / 100° Diffused Beam

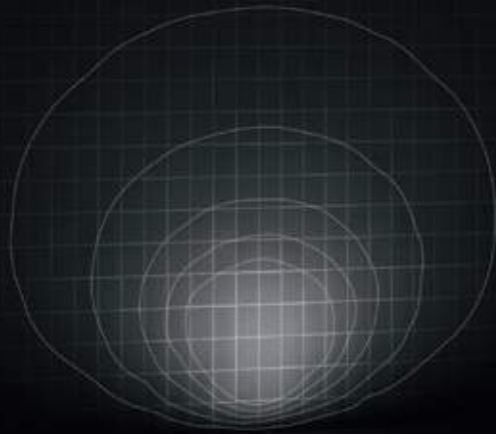

Trail
Solid Line

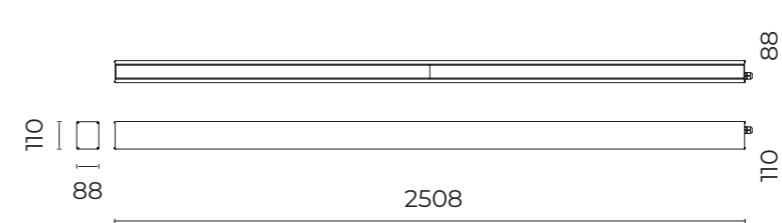

KORE

Up-light, down-light e wall-washer ad incasso,
KORE è ideale per l'illuminazione d'accento o
diffusa di facciate, aree verdi e spazi urbani.

Up-light, down-light and recessed wall-washer,
KORE is ideal for accent and diffuse lighting of
facades, green areas and urban spaces.





DATI PRESTAZIONALI / PERFORMANCE DATA

Flusso apparecchio / Fitting flux:
970 - 1225 lm

Potenza apparecchio / Fitting power:
18 W

Indice di resa cromatica / Colour Rendering Index:
CRI ≥ 90, SDCM ≤ 3

Illuminazione intelligente / Smart lighting:
DALI

TEMPERATURA COLORE COLOUR TEMPERATURE

- 2700 K
- 3000 K
- 4000 K

MATERIALI / MATERIALS

Corpo / Body:
pressofusione di alluminio in lega primaria EN AB 44300
die-cast primary aluminium alloy EN AB 44300

Schermo / Screen:
vetro piano temprato / flat tempered glass

Gruppo ottico / Optical unit:
lenti in tecnopolimero ad alta trasparenza
high-transparency technopolymer lenses

Finitura / Finish:
cornice INOX AISI 316L con finitura sabbiata e micro-
pallinata con sfere di vetro / INOX AISI 316L stainless
steel frame with sandblasted and micro-shot glass-
sphere peened finish

COLORI / COLOURS

- INOX AISI 316L

CARATTERISTICHE / FEATURES

Peso massimo / Max weight:
2 kg

Alimentazione elettronica / Electronic power supply:
remota, da ordinare separatamente / remote, to be
ordered separately

Precablaggio / Pre-wiring:
incluso / included

Installazione / Installation:
terra (carrabile), pavimento flottante, controsoffitto
ground (drive over), floating floor, false ceiling

Sistema ottico orientabile / Orientable optical system:
inclinazione: 0°, -5°, -10°, -15°. Rotazione +359°
inclination: 0°, -5°, -10°, -15°. Rotation +359°



OTTICHE / OPTICS

W-W Wall Washer



U-D 90° Diffused Beam



D 45° Wide Beam



M 25° Medium Beam



C 12° Narrow Beam



Kore

Incasso carrabile / Drive over recessed

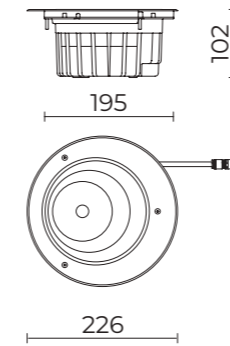

ACCESSORI / ACCESSORIES

06KR901B0
B132 - Controcassa carrabile
 Drive over recessed housing

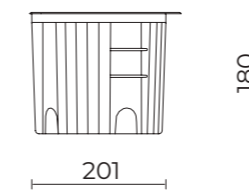

06KR904X0
B149 - Driver elettronico
20W 240V IP67
 Electronic driver 20W 240V IP67

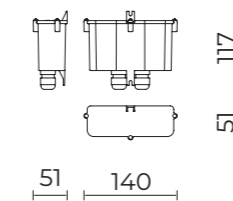

06KR905X0
B150 - Driver elettronico
DALI 20W 240V IP67
 DALI electronic driver
 20W 240V IP67

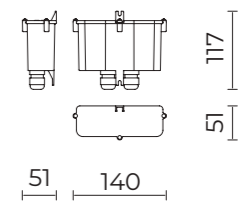

06KS918C0
B137 - Connettore 2 vie IP68
 2-way connector IP68

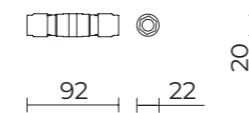

06KS909C0
B89 - Connettore 4 vie IP68
 4-way connector IP68

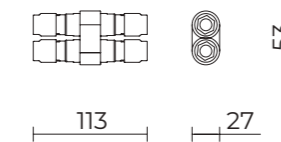

OTTICHE / OPTICS

W-W Wall Washer



U-D 90° Diffused Beam



D 45° Wide Beam



M 25° Medium Beam



C 12° Narrow Beam



Kore

Incasso soffitto / Ceiling recessed

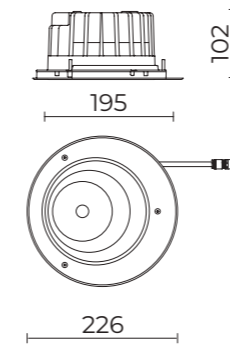

ACCESSORI / ACCESSORIES

06KR903XX0
B134 - Molle per incasso a soffitto
 Springs for ceiling recessed installation

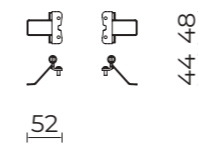

06KR904X0
B149 - Driver elettronico
20W 240V IP67
 Electronic driver 20W 240V IP67

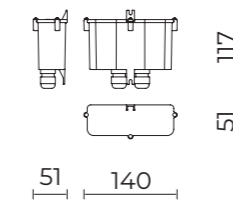

06KR905X0
B150 - Driver elettronico DALI
20W 240V IP67
 DALI electronic driver
 20W 240V IP67

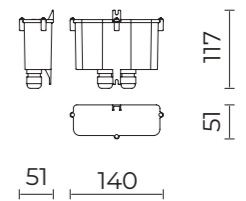

06KS918C0
B137 - Connettore 2 vie IP68
 2-way connector IP68

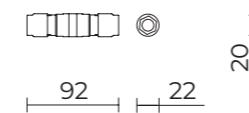

06KS909C0
B89 - Connettore 4 vie IP68
 4-way connector IP68

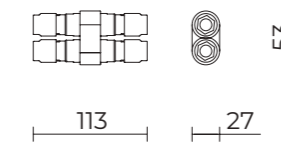

Kore



LACEDONIA
Italy

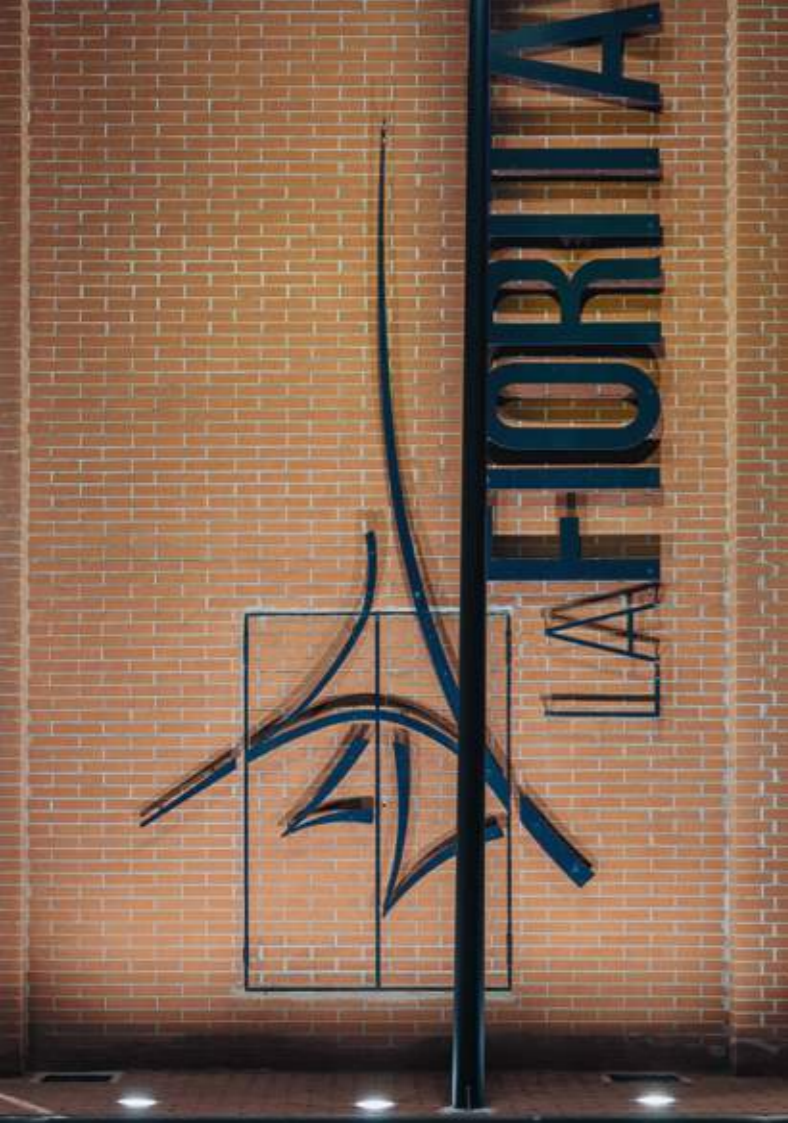

FINALE EMILIA
Italy

BANISTER

BANISTER è un corrimano ed elemento luminoso adatto per l'illuminazione uniforme di camminamenti, scale, corridoi, ponti pedonali.

BANISTER is both a handrail and a light, ideal for evenly lighting walkways, stairs, corridors and pedestrian bridges.







* individual module ** continuous line *** handrail

DATI PRESTAZIONALI / PERFORMANCE DATA

Flusso apparecchio / Fitting flux:
115 - 460 lm

Potenza apparecchio / Fitting power:
2,5 - 10W

Indice di resa cromatica / Colour Rendering Index:
CRI ≥ 80, SDCM ≤ 3

TEMPERATURA COLORE COLOUR TEMPERATURE

 3000 K

MATERIALI / MATERIALS

Corpo / Body:
estrusione di lega d'alluminio UNI6060
extruded aluminium alloy UNI 6060

Staffe / Brackets:
pressofusione di lega d'alluminio UNI EN
AB 47100 (contenuto rame < 1%)
die-cast aluminium alloy UNI EN
AB 47100 (copper content < 1%)

Gruppo ottico / Optical unit:
orientabile su 360° con step da 45°
orientable through 360° in steps of 45°

Finitura / Finish:
fosfocromatazione e verniciatura in polveri
di poliestere realizzata in 16 fasi per la miglior
resistenza agli agenti atmosferici
phospho-chromatation treated and polyester
powder-coated in 16 phases to increase
weather resistance

COLORI / COLOURS

 SABLÉ 100 NOIR

CARATTERISTICHE / FEATURES

Peso massimo / Max weight:
2 kg

Alimentazione elettronica / Electronic power supply:
inclusa (modulo singolo), remota (linea continua)
included (individual module), remote (continuous line)

Resistenza sovratensioni / Surge Protection Device:
MC 6 kV
MD 10 kV

Installazione / Installation:
parete / wall

Fissaggio / Fixing system:
staffa fissa / fixed bracket





Banister Parete / Wall

INDIVIDUAL MODULE driver included

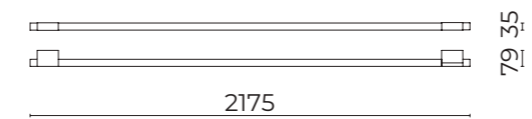
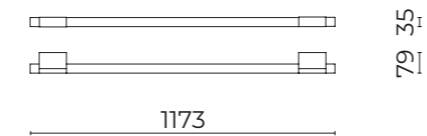
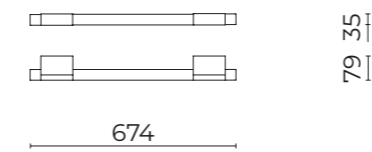

CONTINUOUS LINE

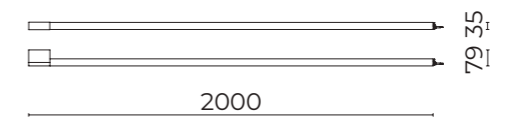
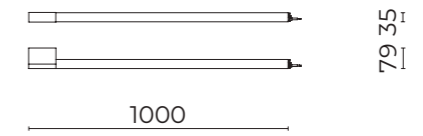
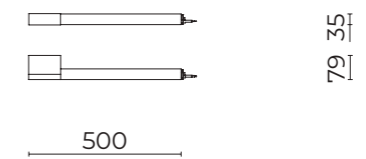

Banister

Parete / Wall

ACCESSORI / ACCESSORIES

06BA900CO
Kit 2 terminali e staffa
Kit with 2 terminal parts and brackets

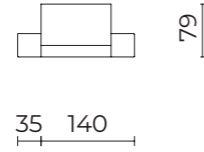

06TA902XO
Driver elettronico 60W 24V IP66
Electronic driver 60W 24V IP66

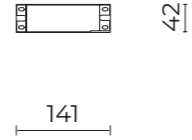

06LL914ABO
Driver elettronico DALI 150W 24V IP67
DALI electronic driver 150W 24V IP67

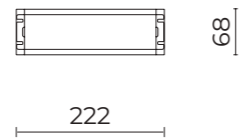

06LL915ABO
Driver elettronico 240W 24V IP67
Electronic driver 240W 24V IP67

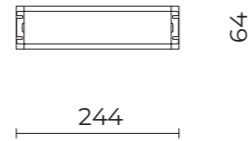

EMI

EMI è stato ideato per l'illuminazione d'accento delle superfici di confine e degli spazi di passaggio tra l'interiorità e l'esteriorità urbana: soglie, muri, nicchie, portici, portali e finestre.

EMI was designed for accent lighting of border surfaces and transit spaces between urban interiors and exteriors: thresholds, walls, niches, arcades, portals and windows.





MILAN
Italy



220 240V	24Vdc DALI	50 60Hz	CL II CL III	IP66	BL IK08 AD IK07	ta -30°C +50°C
-------------	---------------	------------	-----------------	------	--------------------	----------------------



DATI PRESTAZIONALI / PERFORMANCE DATA

Flusso apparecchio / Fitting flux:
135 - 160 lm

Potenza apparecchio / Fitting power:
4 W (versione DALI), 4,7 W (versione ON-OFF)
4 W (DALI version), 4,7 W (ON-OFF version)

Indice di resa cromatica / Colour Rendering Index:
CRI ≥ 80, SDCM ≤ 3

Illuminazione intelligente / Smart lighting:
DALI, driver esterno / DALI, external driver

MATERIALI / MATERIALS

Corpo e cover / Body and cover:
pressofusione di lega d'alluminio UNI EN AB 47100
(contenuto rame < 1%) / die-cast aluminum alloy
UNI EN AB 47100 (copper content < 1%)

Gruppo ottico / Optical unit:
lente PMMA ad alta trasparenza
high-transparency PMMA lenses

Finitura / Finish:
fosfocromatazione e verniciatura in polveri di poliestere
realizzata in 16 fasi per la miglior resistenza agli
agenti atmosferici / phospho-chromatation treated
and polyester powder-coated in 16 phases to increase
weather resistance

CARATTERISTICHE / FEATURES

Peso massimo / Max weight:
0,6 kg



Alimentazione elettronica / Electronic power supply:
versione ON-OFF inclusa, versione DALI esclusa
ON-OFF version included, DALI version external

Precablaggio / Pre-wiring:
incluso, fornito con cavo 1,5 m
included, provided with cable 1,5 m

Installazione / Installation:
parete, soffitto. Accesso cavo posteriore e laterale
wall-mounted, ceiling. Bottom and side access point
for the power cable

Fissaggio / Fastening:
Il sistema di fissaggio consente un'inclinazione in
regolazione continua fino a 5°, per compensare eventuali
pendenze delle superfici di installazione
The fastening system allows a continuously adjustable
inclination of up to 5° to compensate for any sloping
installation surfaces

TEMPERATURA COLORE COLOUR TEMPERATURE

-  2700 K
-  3000 K
-  4000 K



OTTICHE / OPTICS

Blade 5°x180°



Asymmetric Diffused Beam

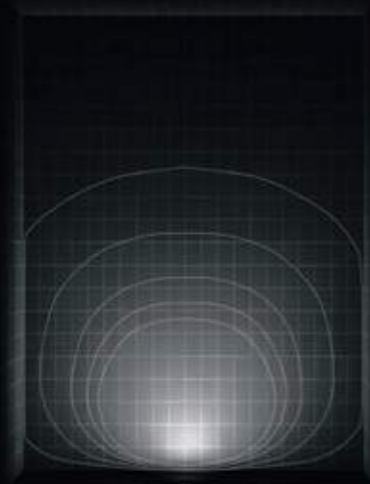

Emi

BL

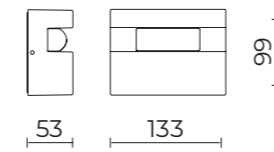

AD

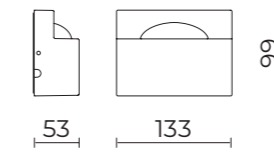

COLORI / COLOURS

- SABLÉ 100 NOIR
- RAL9006
- CORTEN
- RAL9003

ACCESSORI / ACCESSORIES

06EM900X0
D1 - Driver DALI 20W 24V IP20
N. 1 - 4 EMI / DALI driver 20W 24V
 IP20 N. 1 - 4 EMI

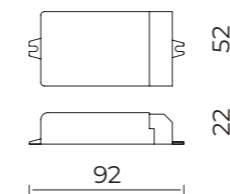

06EM901X0
D2 - Kit driver DALI 20W 24V IP67
N. 1 - 4 EMI / Kit DALI driver 20W
 24V IP67 N. 1 - 4 EMI

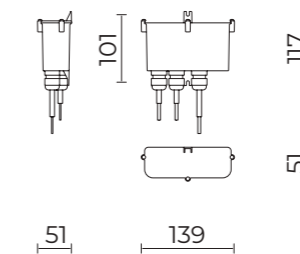

06GC902X0
B165 - Connettore 2 poli IP68
 2-pole connector IP68

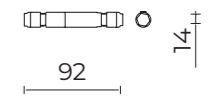

MIKRO



MIKRO è un sistema dedicato all'illuminazione d'accento delle facciate, pensato per disegnare con la luce gli scenari urbani notturni.

MIKRO is a dedicated system for accent lighting of facades and is designed to draw urban night scenes with light.

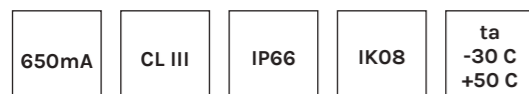

DATI PRESTAZIONALI / PERFORMANCE DATA



Flusso apparecchio / Fitting flux:
135 - 180 lm

Potenza apparecchio / Fitting power:
4 W

Indice di resa cromatica / Colour Rendering Index:
CRI ≥ 80, SDCM ≤ 3

Illuminazione intelligente / Smart lighting:
driver ON-OFF o DALI esterno
external ON-OFF or DALI driver

TEMPERATURA COLORE COLOUR TEMPERATURE

-  2700 K
-  3000 K
-  4000 K

MATERIALI / MATERIALS





Corpo e fissaggio / Body and fastening:
pressofusione di lega d'alluminio UNI EN AB 47100
(contenuto rame < 1%) / die-cast aluminum alloy UNI EN
AB 47100 (copper content < 1%)

Schermo / Screen:
vetro piano temprato
tempered flat glass

Gruppo ottico / Optical unit:
lenti PMMA ad alta trasparenza
high-transparency PMMA lenses

Finitura / Finish:
fosfocromatazione e verniciatura in polveri di poliestere
realizzata in 16 fasi per la miglior resistenza agli
agenti atmosferici / phospho-chromatation treated
and polyester powder-coated in 16 phases to increase
weather resistance

COLORI / COLOURS

-  SABLÉ 100 NOIR
-  RAL9006
-  CORTEN
-  RAL9003

CARATTERISTICHE / FEATURES

Peso massimo / Max weight:
0,5 kg

Alimentazione elettronica / Electronic power supply:
esclusa / excluded

Precablaggio / pre-wiring:
incluso, fornito con cavo 1 m
included, provided with 1 m cable

Inclinazione / Inclination:
Staffa di fissaggio integrata che, se necessario, può
essere regolata per consentire l'inclinazione del prodotto
(-15° ÷ +105°) e l'installazione anche nelle condizioni più
complesse / Built-in fixing bracket that can be adjusted
if necessary to tilt the product (-15° ÷ +105°) and install it
in even the most complex conditions

Installazione / Installation:
terra, parete, soffitto / ground, wall-mounted, ceiling



OTTICHE / OPTICS

Blade 4°x17°

D 50°x20° Wide Beam



M 21°x19° Medium Beam



Mikro

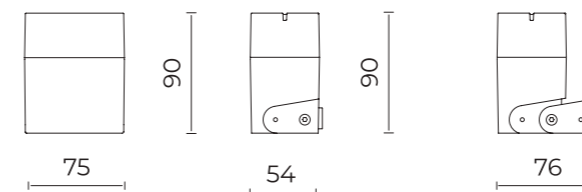

ACCESSORI / ACCESSORIES

06AK957B0
I2 - Picchetto per interramento
 Spike for ground

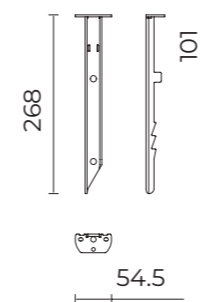

06GC902X0
B165 - Connettore 2 poli
 2 pole connector

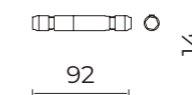

06MK900X0
D3 - Driver 30W 650mA IP20 1 - 6 Mikro
 Driver 30W 650 mA IP20 1 - 6 Mikro



06MK901X0
D4 - Kit driver 650mA IP67 1 - 6 Mikro
 Driver kit 650 mA IP67 1 - 6 Mikro

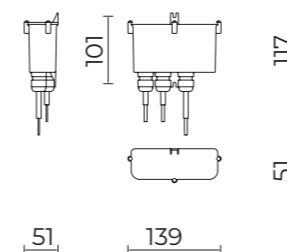

06MK902X0
D5 - Driver DALI 30W 650mA IP68 1 - 6 Mikro
 DALI driver 30W 650 mA IP68 1 - 6 Mikro

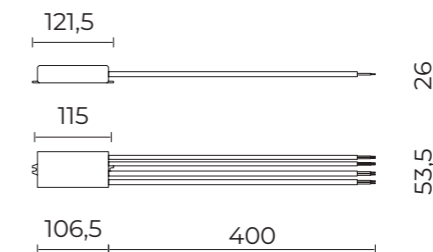



GRAPHO &

GRAPHO
MINI

Soluzioni per l'illuminazione
d'accento delle facciate, pensate per disegnare
con la luce gli scenari urbani notturni.

Solutions for accent lighting of
facades, designed to draw urban night scenes
with light.



VARAZZE
Italy



220 240V	50 60Hz	CL I * CL II **	IP66	IK08	ta -30°C +50°C
-------------	------------	--------------------	------	------	----------------------



* Grapho mini

** Grapho

DATI PRESTAZIONALI / PERFORMANCE DATA

Flusso apparecchio / Fitting flux:
135 - 710 lm

Potenza apparecchio / Fitting power:
4,5 - 17,5 W

Indice di resa cromatica / Colour Rendering Index:
CRI ≥ 80, SDCM ≤ 3

Illuminazione intelligente / Smart lighting:
DALI, incluso / DALI, included

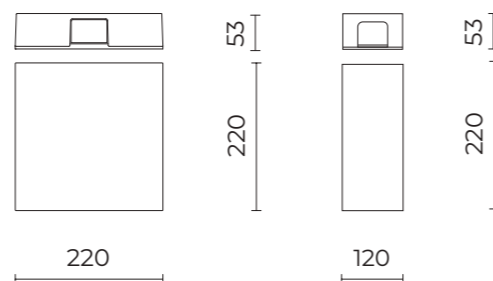

MATERIALI / MATERIALS

Corpo e fissaggio / Body and fastening:
pressofusione di lega di alluminio UNI EN AB 47100
(contenuto rame < 1%) / die-cast aluminum alloy UNI EN
AB 47100 (copper content < 1%)

Schermo / Screen:
tecnopolimero stabilizzato ai raggi UV
UV stabilized technopolymer

Gruppo ottico / Optical unit:
lenti PMMA ad alta trasparenza
high-transparency PMMA lenses

Finitura / Finish:
fosfocromatazione e verniciatura in polveri di poliestere
realizzata in 16 fasi per la miglior resistenza agli
agenti atmosferici / phospho-chromatation treated
and polyester powder-coated in 16 phases to increase
weather resistance

**TEMPERATURA COLORE
COLOUR TEMPERATURE**

- 2700 K
- 3000 K
- 4000 K

COLORI / COLOURS

- SABLÉ 100 NOIR
- RAL9006
- CORTEN
- RAL9003

CARATTERISTICHE / FEATURES

Peso massimo / Max weight:
1 kg (Grapho mini), 1,5 kg (Grapho)

Alimentazione elettronica / Electronic power supply:
inclusa / included

Installazione / Installation:
parete, soffitto. Ingresso cavo posteriore. Predisposizione per
entra-esci (solo Grapho) / wall-mounted, ceiling. Rear cable
entry. Predisposition to in and out setup (only Grapho)

Sistema antivandalismo / Vandal-proof system:
previsti grani antivandalici
anti-vandalism grains provided



2x Blade 4°x17°



4x Blade 4°x17°

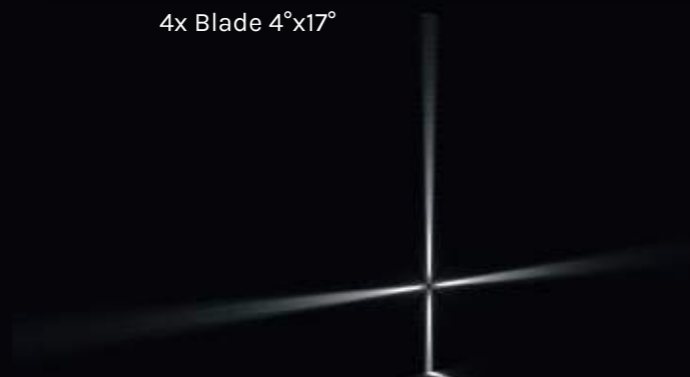

2x D 21°x19° Medium Beam



4x D 21°x19° Medium Beam



2x D 50°x20° Wide Beam



4x D 50°x20° Wide Beam



2x U-D 100°x60° Diffused Beam



U-D 100°x60° Diffused Beam



1x blade 4°x17° + 1x D 21°x19°
Medium Beam



2x blade 4°x17° + 2x D 21°x19°
Medium Beam



1x blade 4°x17° + 1x U-D 100°x60°
Diffused Beam

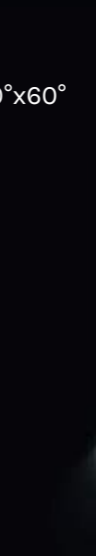

2x blade 4°x17° + 2x U-D 100°x60°
Diffused Beam

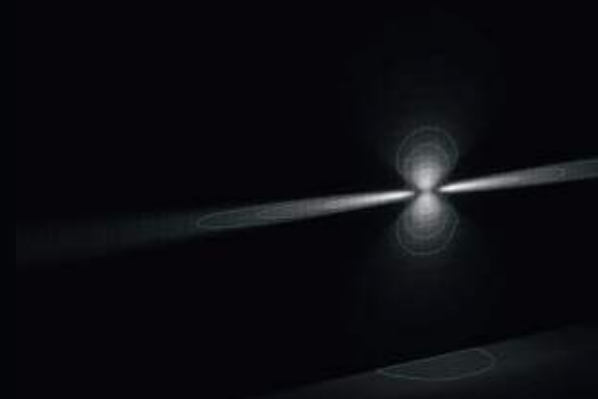

Grapho mini

OTTICHE / OPTICS

1x Blade 4°x17°



2x Blade 4°x17°



1x D 21°x19° Medium Beam



2x D 21°x19° Medium Beam



1x D 50°x20° Wide Beam



2x D 50°x20° Wide Beam



1x U-D 100°x60° Diffused Beam



2x U-D 100°x60° Diffused Beam



1x blade 4°x17° + 1x D 21°x19°
Medium Beam



1x blade 4°x17° + 1x U-D 100°x60°
Diffused Beam





SANS SERIF

SANS SERIF rappresenta il silenzio della forma e l'eloquenza della funzione. Un'illuminazione discreta per camminamenti, scale e rampe, che si inserisce con garbo in ogni contesto.

SANS SERIF represents silence of form and eloquence of function. Discreet lighting for walkways, stairs and ramps, which fits into every context with grace.



BUDAPEST
Hungary



NOLI
Italy

220 240V	50 60Hz	CL I (MQ-MR)	CL III (SQ)	IP66	IK08	ta -30°C +50°C
-------------	------------	-----------------	----------------	------	------	----------------------



DATI PRESTAZIONALI / PERFORMANCE DATA

Flusso apparecchio / Fitting flux:
190 - 290 lm

Potenza apparecchio / Fitting power:
4,5 - 7,5 W

Indice di resa cromatica / Colour Rendering Index:
CRI ≥ 80, SDCM ≤ 3

Illuminazione intelligente / Smart lighting:
DALI su richiesta / DALI on request

MATERIALI / MATERIALS

Corpo e cover / Body and cover:
pressofusione di lega d'alluminio UNI EN AB 47100 (contenuto rame < 1%) / die-cast aluminium alloy UNI EN AB 47100 (copper content < 1%)

Collimatore ottico / Optical collimator:
nylon PA66

Finitura / Finish:
fosfocromatazione e verniciatura in polveri di poliestere realizzata in 16 fasi per la miglior resistenza agli agenti atmosferici / phosphochromatation treated and polyester powder-coated in 16 phases to increase weather resistance

TEMPERATURA COLORE / COLOUR TEMPERATURE

- 2700 K
- 3000 K
- 4000 K

COLORI / COLOURS

- SABLÉ 100 NOIR
- RAL9006
- CORTEN
- RAL9003

CARATTERISTICHE / FEATURES

Peso massimo / Max weight:
0,5 kg (SQ), 2 kg (MQ-MR)

Alimentazione elettronica / Electronic power supply:
esclusa (SQ), inclusa (MQ-MR)
excluded (SQ), included (MQ-MR)

Installazione / Installation:
parete. Ingresso cavo posteriore.
Su richiesta ingresso cavo laterale
wall. Rear cable entry.
Lateral cable entry on request



OTTICHE / OPTICS

AS-D Asymmetric Diffused Beam



Sans Serif

SMALL
QUADRATO
SQUARED

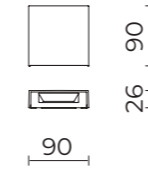

MEDIUM
QUADRATO
SQUARED

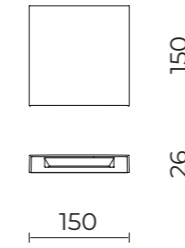

MEDIUM
RETTANGOLARE
RECTANGULAR

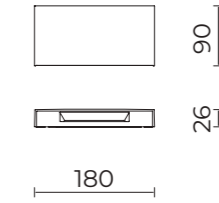

ACCESSORI / ACCESSORIES

06SS900X0
B184 - Driver IP20 350mA 15W,
max 3 SANS SERIF SQ ON-OFF
Driver IP20 350 mA 15 W,
max 3 Sans Serif SQ ON-OFF

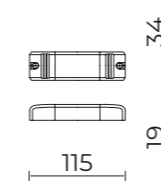

ONE4TWO

Applique da parete, mono-emissione o bi-emissione,
ideale per l'illuminazione d'accento e diffusa di
facciate, portici e ingressi agli edifici.

Wall-mounted, mono-emission or bi-emission
product, ideal for accent and diffuse lighting of
arcades, façades and building entrances.





TORONTO
Canada

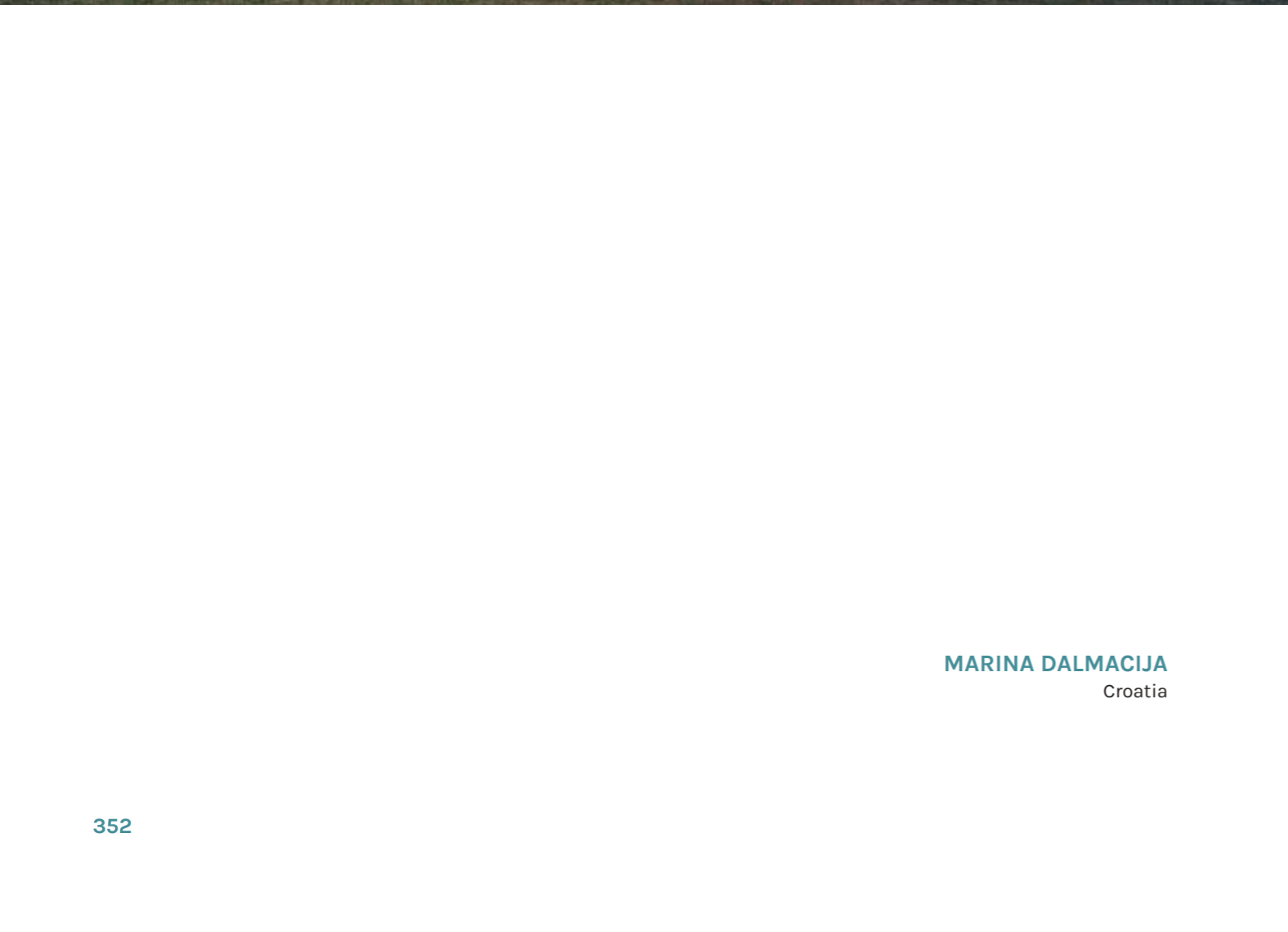

MARINA DALMACIJA
Croatia



220 240V	50 60Hz	CL I	IP65	IK05	ta -30°C +50°C
-------------	------------	------	------	------	----------------------



DATI PRESTAZIONALI / PERFORMANCE DATA

Flusso apparecchio / Fitting flux:
465 - 2200 lm

Potenza apparecchio / Fitting power:
7 - 31 W

Indice di resa cromatica / Colour Rendering Index:
CRI ≥ 80, SDCM ≤ 3

TEMPERATURA COLORE COLOUR TEMPERATURE

-  3000 K
-  4000 K

MATERIALI / MATERIALS

Corpo / Body:
estrusione di lega d'alluminio UNI9006/1
extruded aluminium alloy UNI 9006/1

Schermo / Screen:
vetro piano temprato
tempered flat glass

Gruppo ottico / Optical unit:
lenti PMMA ad alta trasparenza
high-transparency PMMA lenses

Finitura / Finish:
fosfocromatazione e verniciatura in polveri di poliestere
realizzata in 16 fasi per la miglior resistenza agli
agenti atmosferici / phospho-chromatation treated
and polyester powder-coated in 16 phases to increase
weather resistance

COLORI / COLOURS

-  SABLÉ 100 NOIR
-  RAL9006

CARATTERISTICHE / FEATURES

Peso massimo / Max weight:
2 kg (small), 4 kg (medium)

Alimentazione elettronica / Electronic power supply:
inclusa / included

Installazione / Installation:
parete / wall



OTTICHE / OPTICS

C 8° Narrow Beam

D 40° + D 40°



D 40° Wide Beam

C 8° + D 40°



C 8° + C 8°



One4two
Parete / Wall

SMALL

MEDIUM

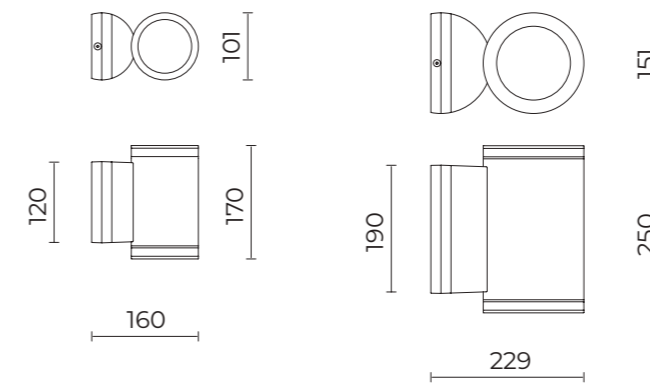

POLI

POLI in greco significa "città"
e lo abbiamo ideato per tutte le città dove
le persone sono più importanti delle cose.
Le città dove passeggiare, fermarsi, incontrarsi.

POLI in Greek means "city", and we have
designed it for all cities where people are more
important than objects.
Cities for walking, stopping, meeting.



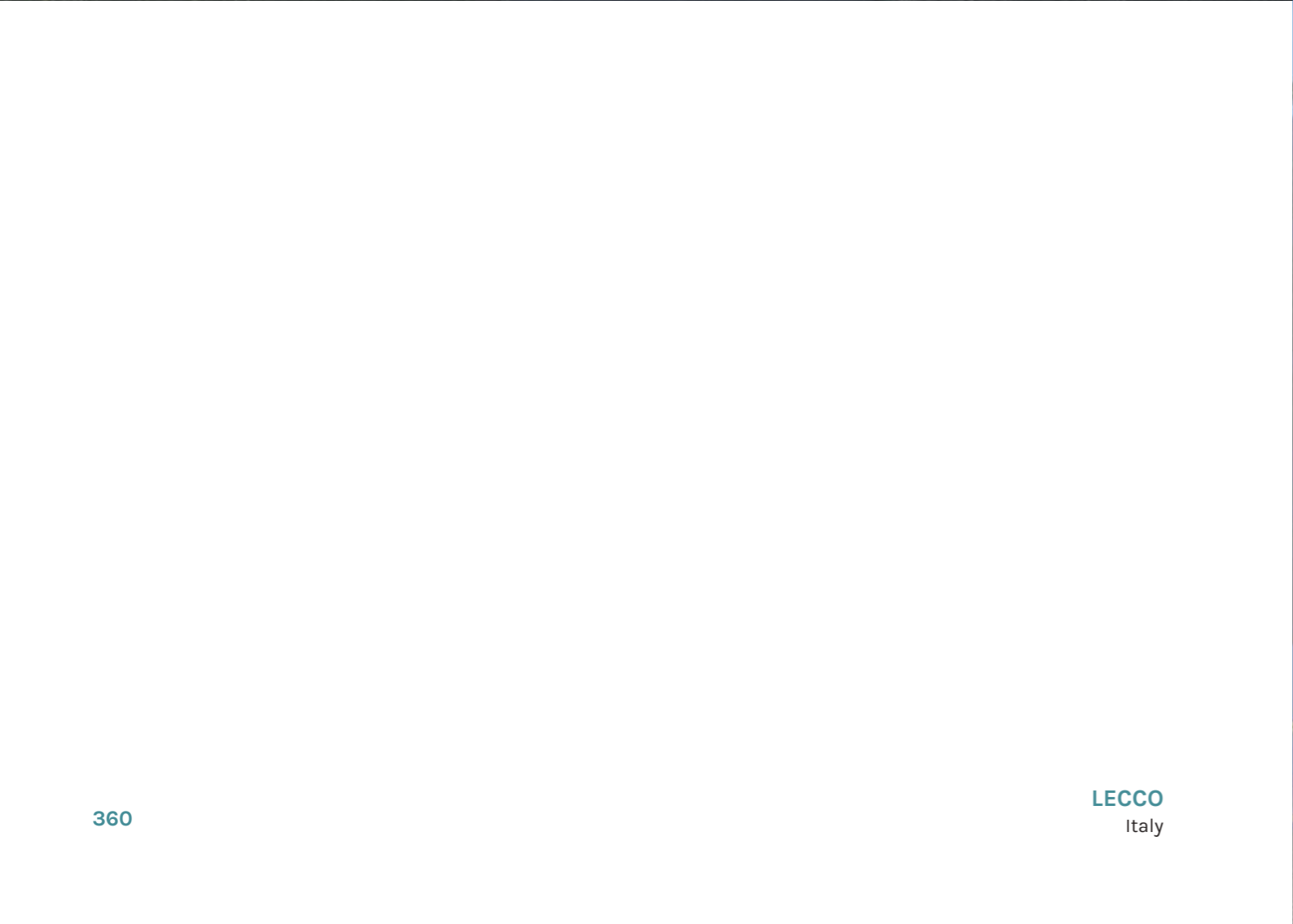
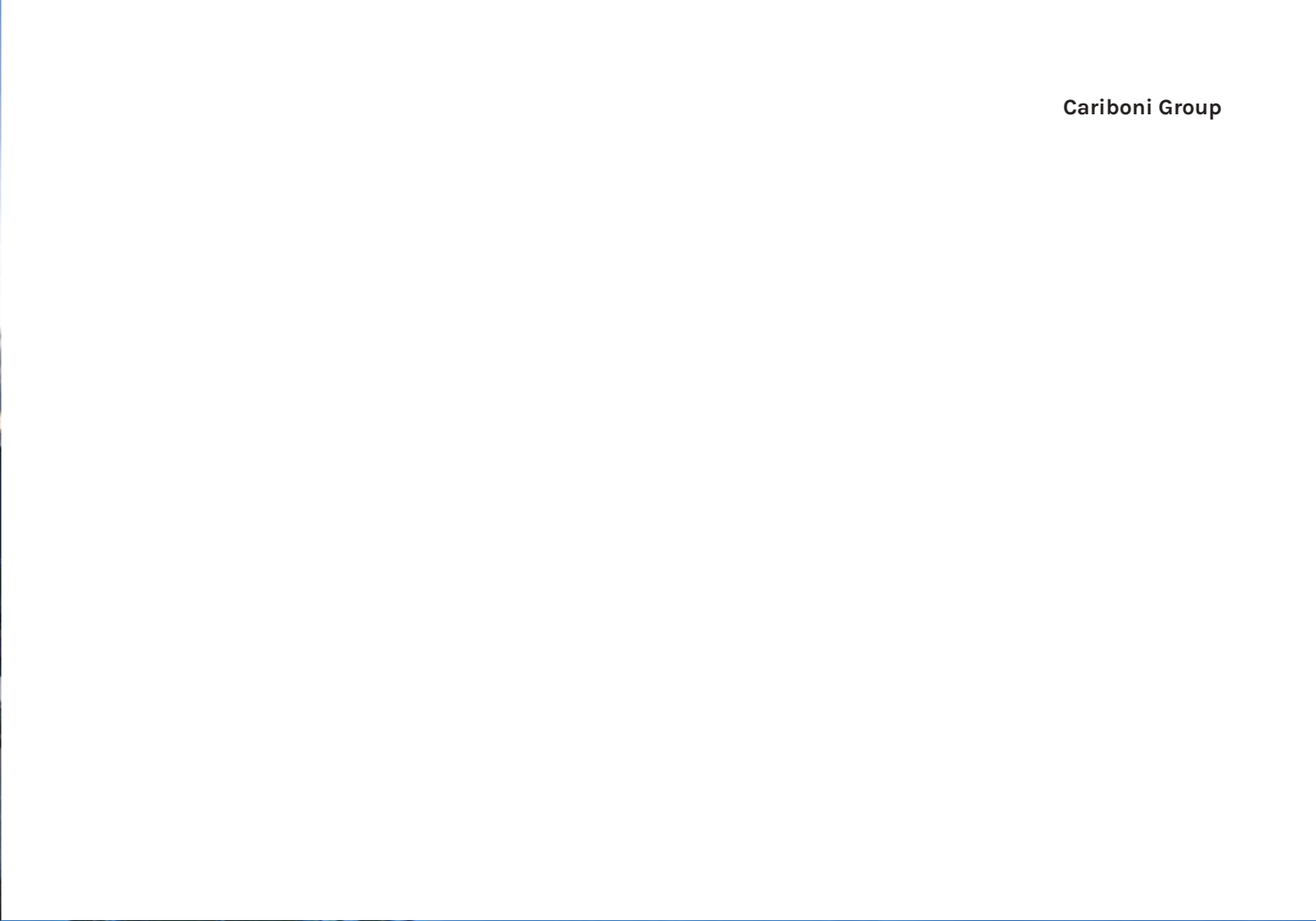

220 240V	50 60Hz	CL II	IP66	IK09	ta -30°C +50°C
-------------	------------	-------	------	------	----------------------



DATI PRESTAZIONALI / PERFORMANCE DATA

Flusso apparecchio / Fitting flux:
1355 (1800 K) - 10835 lm

Potenza apparecchio / Fitting power:
12 - 78 W

Indice di resa cromatica / Colour Rendering Index:
CRI ≥ 70, SDCM ≤ 3

Illuminazione intelligente / Smart lighting:
mezzanotte virtuale. Su richiesta DALI, ZHAGA, CLO
virtual midnight. On request DALI, ZHAGA, CLO

MATERIALI / MATERIALS

Corpo e sistemi di fissaggio / Body and fitting system:
pressofusione di lega d'alluminio UNI EN AB 47100
(contenuto rame < 1%) / die-cast aluminum alloy UNI EN AB
47100 (copper content < 1%)

Schermo / Screen:
vetro piano temprato / tempered flat glass

Gruppo ottico / Optical unit:
lenti PMMA ad alta trasparenza
high-transparency PMMA lenses

Finitura / Finish:
fosfocromatazione e verniciatura in polveri di poliestere
realizzata in 16 fasi per la miglior resistenza agli agenti
atmosferici / phospho-chromatation treated and polyester
powder-coated in 16 phases to increase weather resistance

TEMPERATURA COLORE COLOUR TEMPERATURE

- 2200 K
- 2700 K
- 3000 K
- 4000 K

ECO-CENTRIC LIGHTING (ECL)

(ONLY FOR STREET OPTICS)

BLUE FREE LIGHT:
PC-AMBER 0,7% ΣR ($\lambda < 500\text{NM}$) – CRI 40
1800 K 4,3% ΣR ($\lambda < 500\text{NM}$) – CRI 70

SWITCHABLE WHITE LIGHT:
1800K / 3000K

COLORI / COLOURS

- SABLÉ 100 NOIR

CARATTERISTICHE / FEATURES

Peso massimo / Max weight:
8 kg

Alimentazione elettronica / Electronic power supply:
inclusa / included

Resistenza sovratensioni / Surge Protection Device:
10 kV MC/MD

Precablaggio / Pre-wiring:
prodotto fornito con cavo e connettore
product provided with cable and connector

Installazione / Installation:
pali cima Ø 60 mm innesto H 90 mm
poles with post top Ø 60 mm and fastening part H 90 mm



OTTICHE / OPTICS

LT-C1 Cycle path
L / H = 0,5

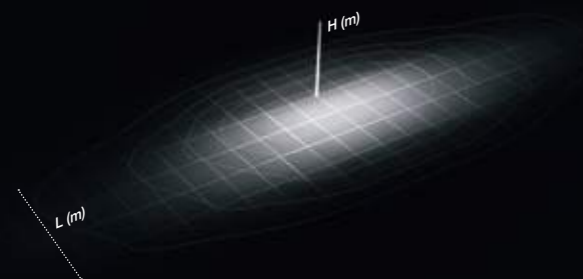

ST-02 Narrow Street
L / H = 0,75

ECL

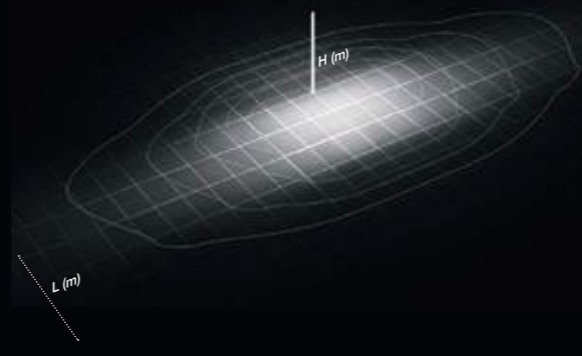

LT-64 Asymmetric Beam with backlight
L / H = 2

ECL

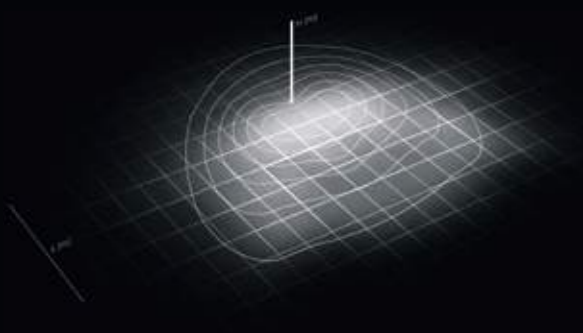

ME-05 Medium Street
L / H = 1

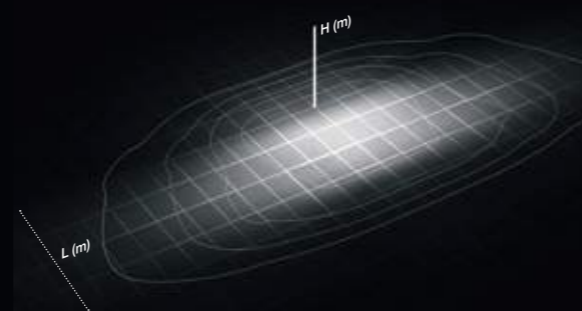

RS-02 Rotosymmetric Beam

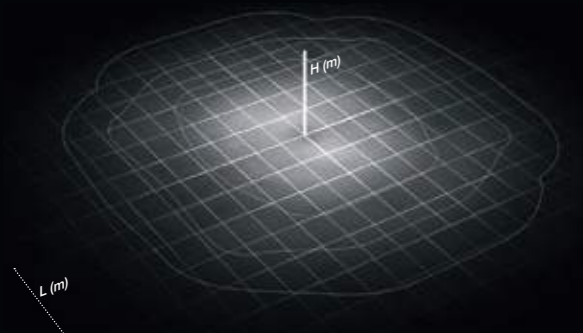

LA-03 Wide Street
L / H = 1,25

ECL

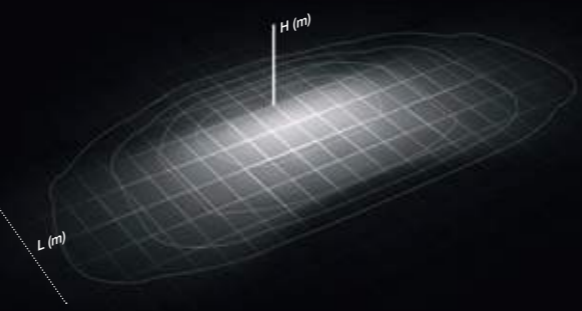

Poli

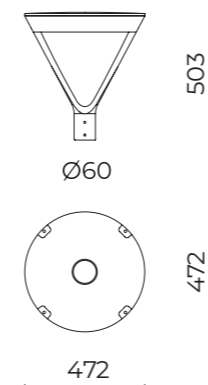

ACCESSORI / ACCESSORIES

- 01PL900C0 - Sablè 100 Noir
- 01PL900U60 - Copper
- 01PL900U50 - Green
- Cappello decorativo
Decorative upper cover

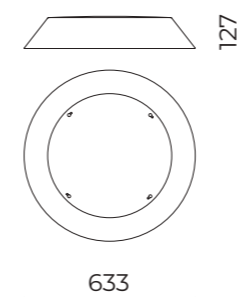

- 01AK980C0
B200 - Adattatore pali
Pole adapter

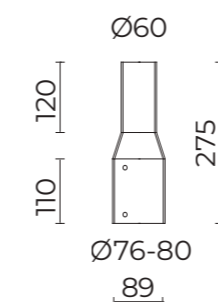

DUAL



Una soluzione intelligente per l'illuminazione di spazi e percorsi urbani. Le linee morbide e le forme eleganti lo rendono adatto ad ogni contesto.

A smart solution for lighting urban spaces and pathways. Its soft lines and elegant shapes make it suitable for any context.



MIAMI
USA



GENOVA
Italy

220 240V	50 60Hz	CL II	IP66	IK08	ta -30°C +50°C
-------------	------------	-------	------	------	----------------------



DATI PRESTAZIONALI / PERFORMANCE DATA

Flusso apparecchio / Fitting flux:
1650 - 10835 lm

Potenza apparecchio / Fitting power:
12 - 78 W

Indice di resa cromatica / Colour Rendering Index:
CRI ≥ 70, SDCM ≤ 3

Illuminazione intelligente / Smart lighting:
mezzanotte virtuale. Su richiesta DALI, ZHAGA, CLO
virtual midnight. On request DALI, ZHAGA, CLO

TEMPERATURA COLORE COLOUR TEMPERATURE

- 2700 K
- 3000 K
- 4000 K

MATERIALI / MATERIALS

Corpo e codolo / Body and fastening part:
pressofusione di lega d'alluminio UNI EN AB 47100
(contenuto rame < 1%) / die-cast aluminium alloy UNI EN
AB 47100 (copper content < 1%)

Schermo / Screen:
policarbonato trasparente stabilizzato agli UV
con fotoincisione / transparent polycarbonate UV
stabilized with photoengraving

Gruppo ottico / Optical unit:
lenti PMMA ad alta trasparenza / high-transparency
PMMA lenses

Finitura / Finish:
fosfocromatazione e verniciatura in polveri di poliestere
realizzata in 16 fasi per la miglior resistenza agli
agenti atmosferici / phospho-chromatation treated
and polyester powder-coated in 16 phases to increase
weather resistance

COLORI / COLOURS

- SABLÉ 100 NOIR

CARATTERISTICHE / FEATURES

Peso massimo / Max weight:
6 kg

Alimentazione elettronica / Electronic power supply:
inclusa / included

Resistenza sovratensioni / Surge Protection Device:
10 kV MC/MD

Precablaggio / Pre-wiring:
incluso, fornito con cavo e connettore
included, provided with cable and connector

Installazione / Installation:
pali cima Ø 60 mm innesto H 70 mm
poles for post top Ø 60 mm and
fastening part H 70 mm



ASIMMETRICO
ASYMMETRICAL



RTOSIMMETRICO
RTOSYMMETRICAL

OTTICHE / OPTICS

LT-C1 Cycle path
L / H = 0,5

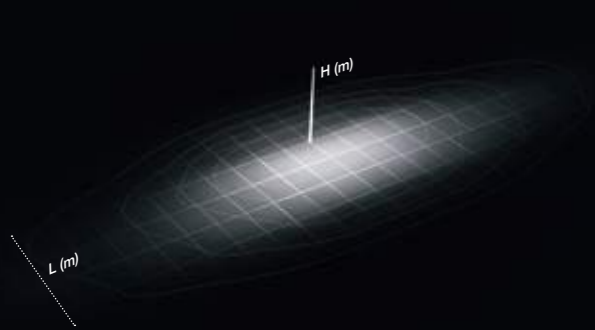

LA-03 Wide Street
L / H = 1,25

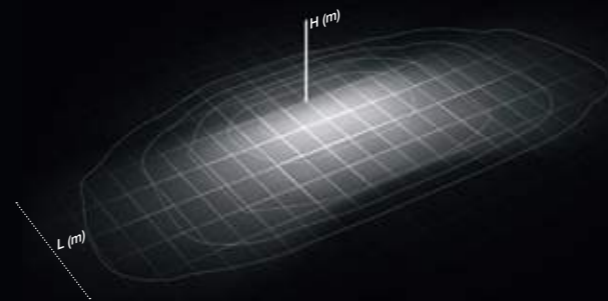

LT-64 Asymmetric Beam with backlight
L / H = 2

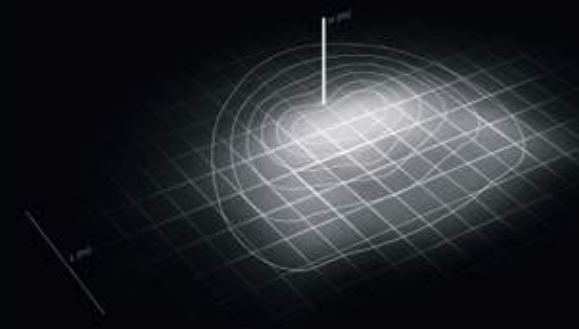

RS-02 Rotosymmetric Beam

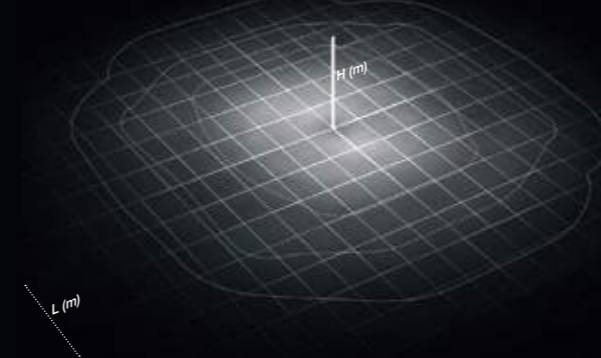

Rotosimmetrico
Rotosymmetrical

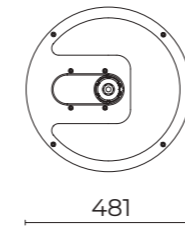
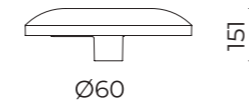

Asimmetrico
Asymmetrical

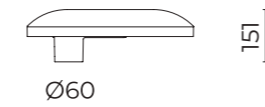

KALOS

Flessibilità d'installazione e prestazioni del sistema ottico rendono KALOS una soluzione efficace per l'illuminazione di spazi e percorsi urbani.

Flexibility of installation and performance of the optical system make KALOS an effective solution of lighting urban spaces and pathways.





220 240V	50 60Hz	CL II	IP66	IK09	ta -30°C +50°C
-------------	------------	-------	------	------	----------------------



DATI PRESTAZIONALI / PERFORMANCE DATA

Flusso apparecchio / Fitting flux:
1610 - 13895 lm

Potenza apparecchio / Fitting power:
13,5 - 103,5 W

Indice di resa cromatica / Colour Rendering Index:
CRI ≥ 70, SDCM ≤ 4

Illuminazione intelligente / Smart lighting:
mezzanotte virtuale. Su richiesta ZHAGA, DALI, CLO, PLC,
telegestione wireless / virtual midnight. On request
ZHAGA, DALI, CLO, PLC, wireless telemanagement

COLORI / COLOURS

● SABLÉ 100 NOIR

TEMPERATURA COLORE COLOUR TEMPERATURE

- 2200 K (TESTA PALO / POST TOP)
- 3000 K
- 4000 K

MATERIALI / MATERIALS

Corpo e codolo / Body and fastening part:
pressofusione di lega d'alluminio UNI EN AB 47100
(contenuto rame < 1%) / die-cast aluminum alloy UNI EN
AB 47100 (copper content < 1%)

Schermo / Screen:
vetro piano temprato / tempered flat glass

Gruppo ottico / Optical unit:
lenti PMMA ad alta trasparenza
high-transparency PMMA lenses

Finitura / Finish:
fosfocromatazione e verniciatura in polveri di poliestere
realizzata in 16 fasi per la miglior resistenza agli
agenti atmosferici / phospho-chromatation treated
and polyester powder-coated in 16 phases to increase
weather resistance

CARATTERISTICHE / FEATURES

Peso massimo / Max weight:
8 kg

Alimentazione elettronica / Electronic power supply:
inclusa / included

Resistenza sovratensioni / Surge Protection Device:
10 kV MC/MD

Installazione / Installation:
testa palo, lato palo, sospensione braccio, sospensione
tesata, parete, sottoportico
post top, pole side, arm suspension, string suspension,
wall, arcade



OTTICHE / OPTICS

ST-01 Narrow Street
L / H = 0,75

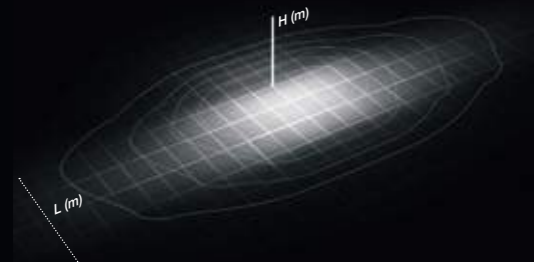

LT-06 Asymmetric Beam
L / H = 2

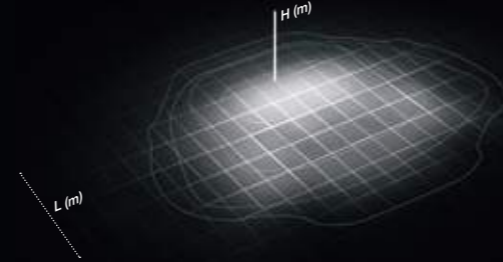

ME-01 Medium Street
L / H = 1

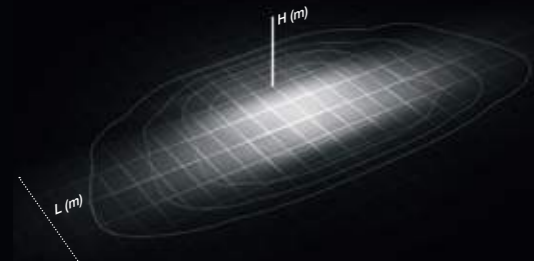

RS-01 Rotosymmetric Beam
L / H = 2

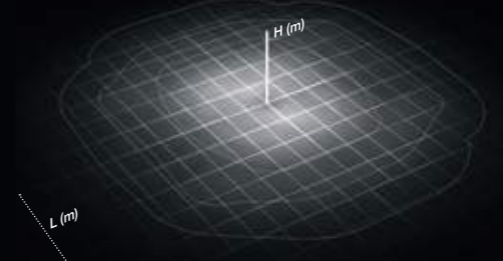

LA-01 Wide Street
L / H = 1,25

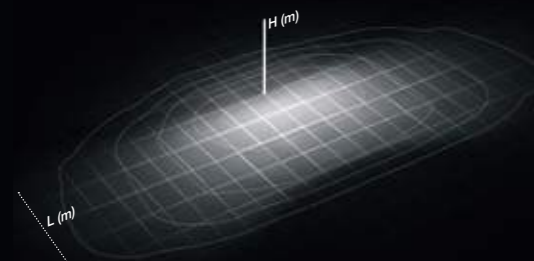

F&B ST-01 + LA-01 Front & Back
L / H = 0,75 + 1,25



Kalos

Testa palo / Post top

DATI TECNICI / TECHNICAL DATA

Installazione / Installations:
pali cima Ø 60 mm innesto H 65 mm
poles for post top Ø 60 mm and fastening part H 65 mm

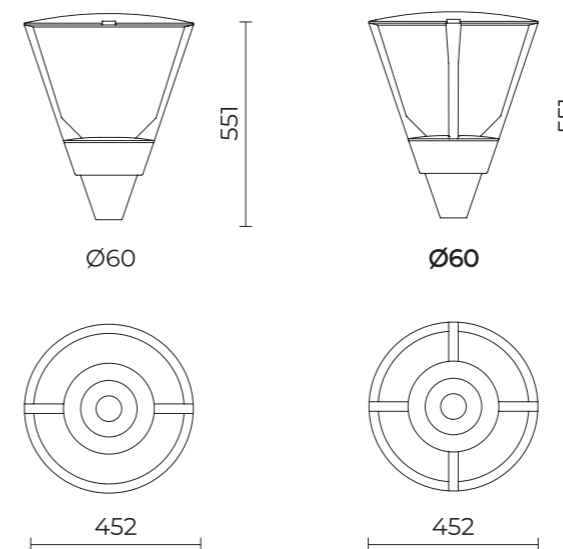

ACCESSORI / ACCESSORIES

01SC913C0
Riduzione codolo
Reduction fastening part

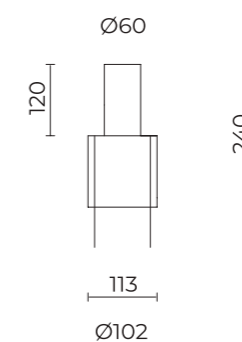

01KA901C0
Cappello per Kalos 4 chele testa
palo o su braccio portato
Cover for Kalos 4 post top arms
or on arm for upwards installation

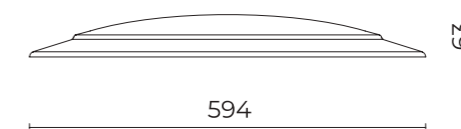

OTTICHE / OPTICS

ST-01 Narrow Street
L / H = 0,75

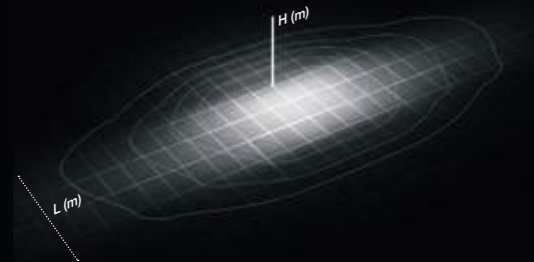

LT-06 Asymmetric Beam
L / H = 2

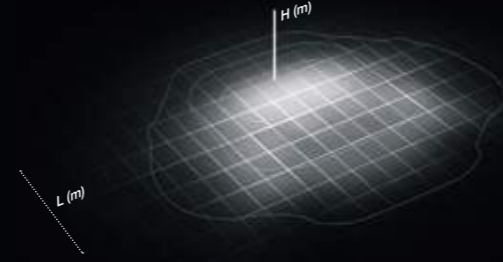

ME-01 Medium Street
L / H = 1

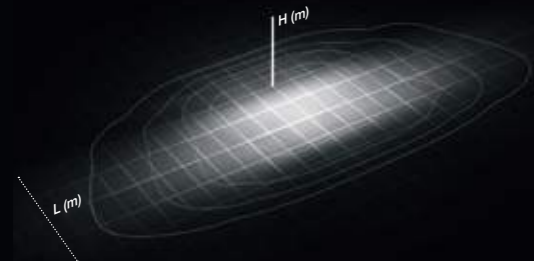

F&B ST-01 + LA-01 Front & Back
L / H = 0,75 + 1,25

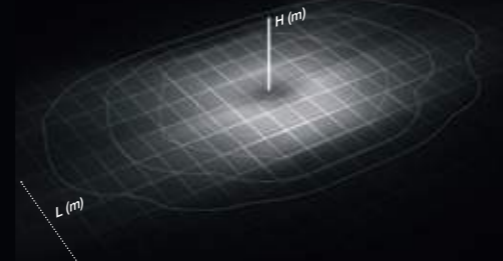

LA-01 Wide Street
L / H = 1,25

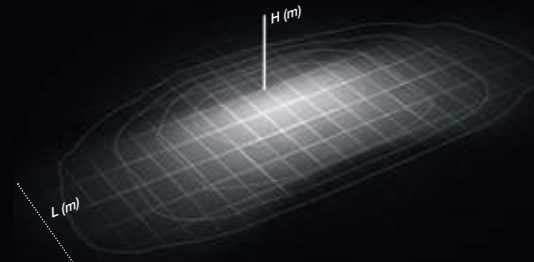

Kalos
Lato palo / Pole side

DATI TECNICI / TECHNICAL DATA

Installazione / Installations:
su bracci con attacco Ø 60 mm per pali Ø 102 mm
on arms with Ø 60 mm fastening for poles Ø 102 mm

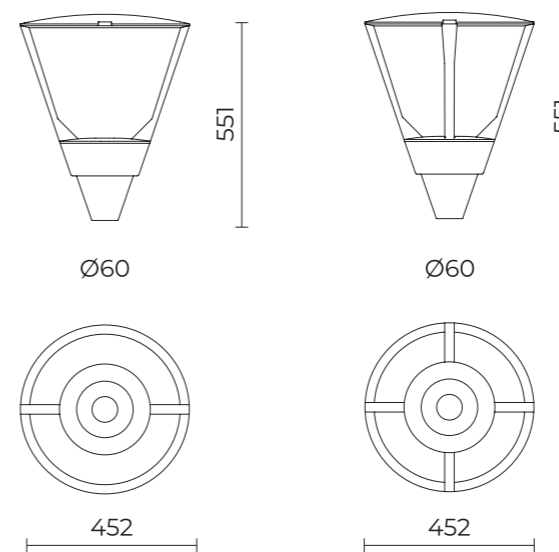

Kalos

Lato palo / Pole side

BRACCI / ARMS

01KA902C0
B35 - Braccio per pali con codolo
 Ø 60 mm H 120 mm
 Arm for poles with fastening part
 Ø 60 mm H 120 mm

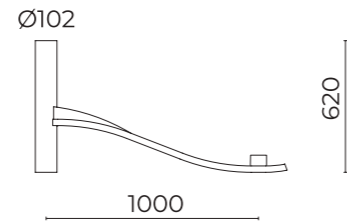

01KA903C0
B36 - Braccio doppio per pali con codolo
 Ø 60 mm H 120 mm
 Double arm for poles with fastening part
 Ø 60 mm H 120 mm

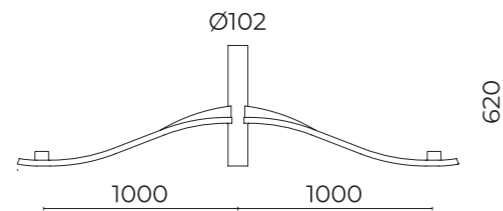

01KA904C0
B37 - Braccio per pali con codolo
 Ø 60 mm H 120 mm
 Arm for poles with fastening part
 Ø 60 mm H 120 mm

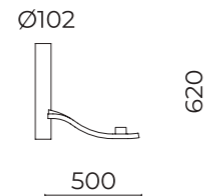

01KA905C0
B38 - Braccio doppio per pali con codolo
 Ø 60 mm H 120 mm
 Double arm for poles with fastening part
 Ø 60 mm H 120 mm

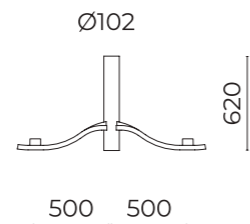

01KA906C0
B39 - Braccio per pali
 Arm for poles

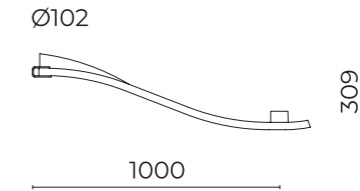

01KA907C0
B44 - Braccio doppio per pali
 Double arm for poles

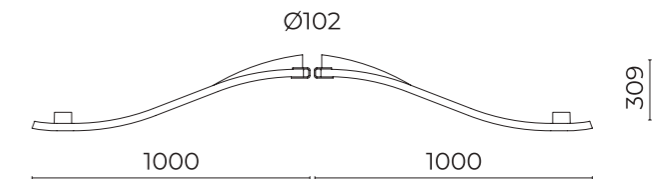

01KA908C0
B45 - Braccio per pali
 Arm for poles

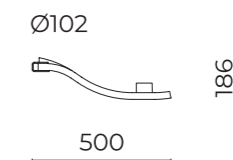

01KA909C0
B46 - Braccio doppio per pali
 Double arm for polespoles

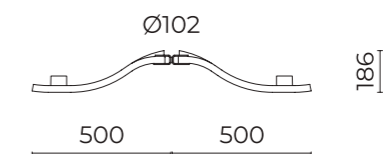



VILNIUS
Lithuania



MILANO
Italy



LOHJA
Finland

OMEGNA
Italy



OTTICHE / OPTICS

ME-01 Medium Street
L / H = 1

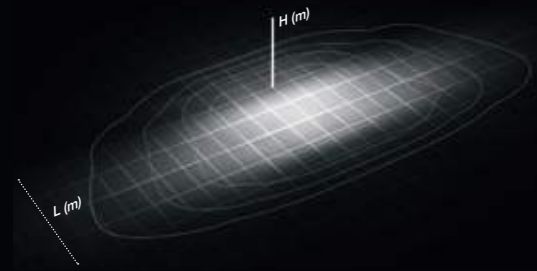

LT-06 Asymmetric Beam
L / H = 2

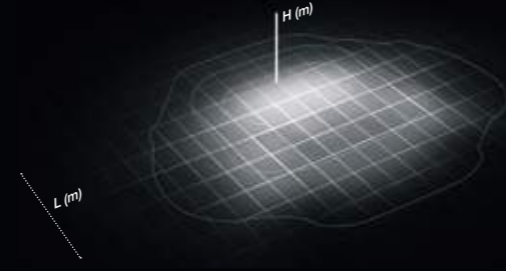

LA-01 Wide Street
L / H = 1,25

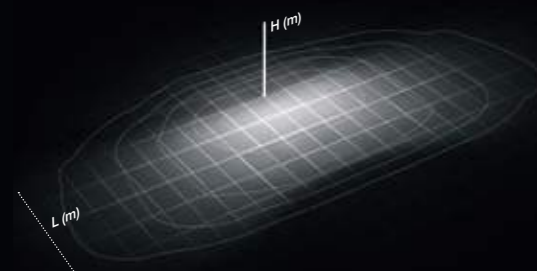

Kalos

Sospensione braccio / Arm suspension

DATI TECNICI / TECHNICAL DATA

Installazione / Installations:

su bracci con attacco Ø 60 mm per pali Ø 102 mm
on arms with Ø 60 mm fastening for poles Ø 102 mm

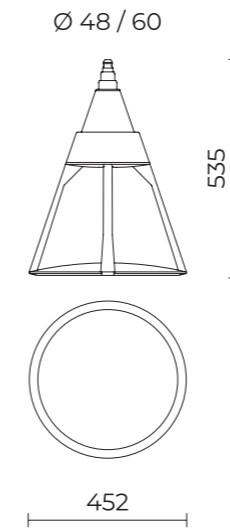

Kalos

Sospensione braccio / Arm suspension

BRACCI / ARMS

01AK935C0
B15 - Braccio pastorale per pali
 Curved arm for poles

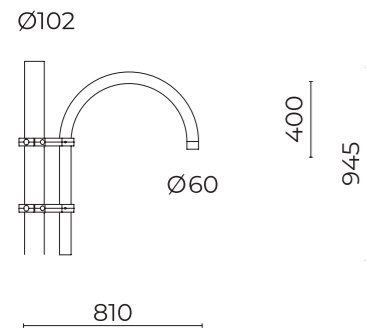

01AK936C0
B16 - Braccio pastorale doppio per pali
 Double curved arm for poles

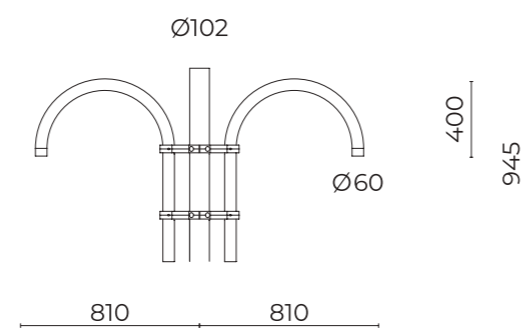

01KA906C0
B39 - Braccio per pali
 Arm for poles

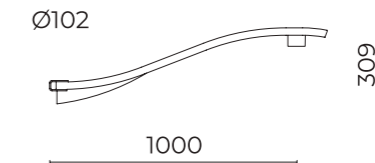

01KA907C0
B44 - Braccio doppio per pali
 Double arm for poles

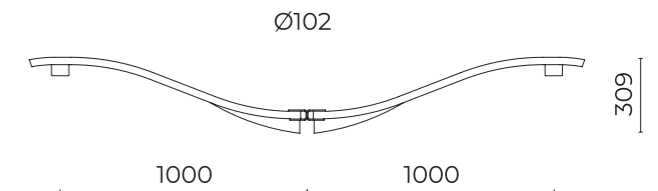

01KA902C0
B35 - Braccio per pali con codolo
 Ø 60 mm H 120 mm / Arm for poles with fastening part Ø 60 mm H 120 mm

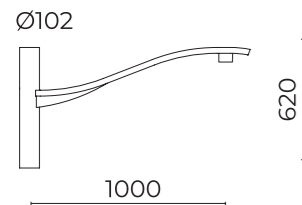

01KA903C0
B36 - Braccio doppio per pali con codolo
 Ø 60 mm H 120 mm / Double arm for poles with fastening part Ø 60 mm H 120 mm

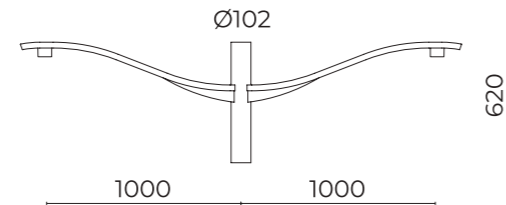

01KA908C0
B45 - Braccio per pali
 Arm for poles

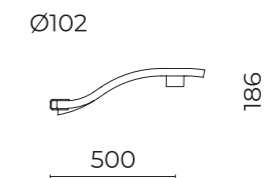

01KA909C0
B46 - Braccio doppio per pali
 Double arm for poles

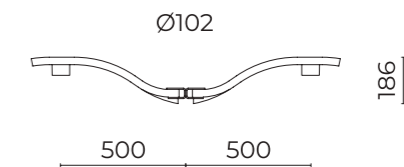

01KA904C0
B37 - Braccio per pali con codolo Ø 60 mm
 H 120 mm / Arm for poles with fastening part Ø 60 mm H 120 mm

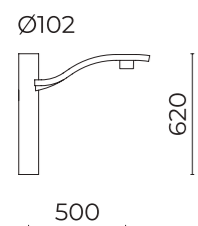

01KA905C0
B38 - Braccio doppio per pali con codolo Ø 60 mm
 H 120 mm / Double arm for poles with fastening part Ø 60 mm H 120 mm

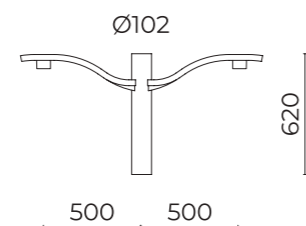

01AK907C0
L16 - Kit sospensione maschio
 Male suspension kit



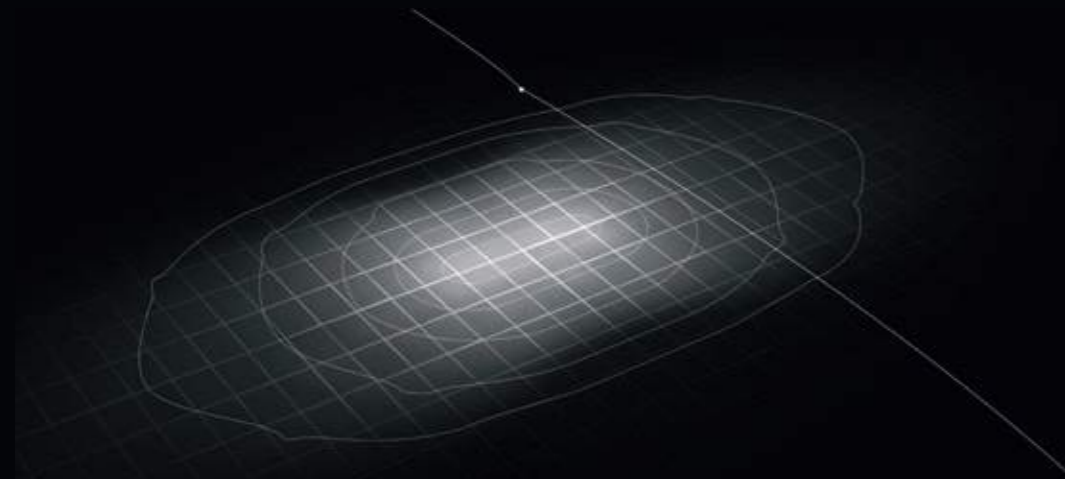

Kalos

Sospensione tesata / String suspension

DATI TECNICI / TECHNICAL DATA

Installazione / Installations:
fune tesata / string suspension

Orientabilità / Adjustability:
0° ÷ 360°

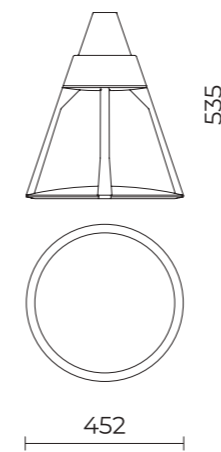

ACCESSORI / ACCESSORIES

01KA925CO

Kit sospensione fune tesata Ø 6 ÷ 12 mm

Suspension kit for string Ø 6 ÷ 12 mm

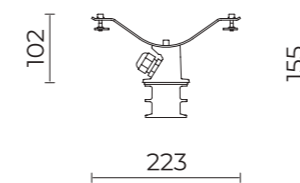

OTTICHE / OPTICS

ST-01 Narrow Street
L / H = 0,75



LA-01 Wide Street
L / H = 1,25



ME-01 Medium Street
L / H = 1



LT-06 Asymmetric Beam
L / H = 2



Kalos
Parete / Wall

DATI TECNICI / TECHNICAL DATA

Installazione / Installations:
su bracci a parete / on wall-mounted arms

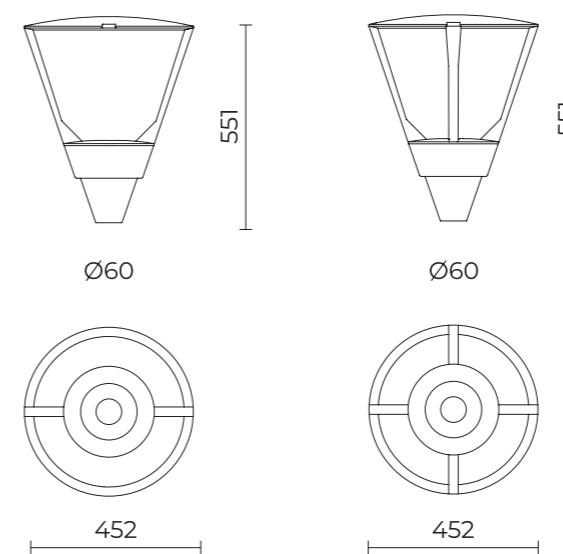

Kalos

Parete / Wall

BRACCI / ARMS

01KA910CO
B39-P - Braccio parete DOWN
Arm wall-mounted DOWN

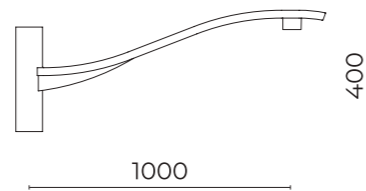

01KA911CO
B45-P - Braccio parete DOWN
Arm wall-mounted DOWN

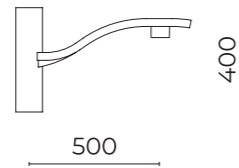

01KA910CO
B39-P - Braccio parete UP
Arm wall-mounted UP

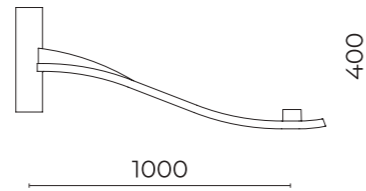

01KA911CO
B45-P - Braccio parete UP
Arm wall-mounted UP

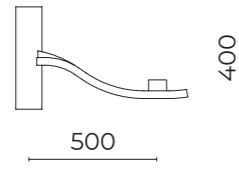

01AK950CO
B15-P - Braccio pastorale parete
Curved arm for wall

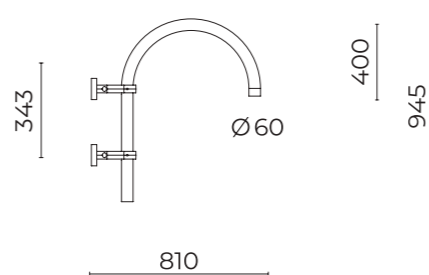

KOSMOS

KOSMOS è un sistema completo e flessibile per l'illuminazione di vuoti e pieni urbani: percorsi, spazi e architetture.

KOSMOS is a complete flexible system for lighting empty and full urban locations: pathways, spaces and architecture.





220 240V	50 60Hz	CL II	IP66	IK09	ta -30°C +50°C
-------------	------------	-------	------	------	----------------------



DATI PRESTAZIONALI / PERFORMANCE DATA

Flusso apparecchio / Fitting flux:
1355 (1800 K) - 16150 lm

Potenza apparecchio / Fitting power:
12 - 108 W

Indice di resa cromatica / Colour Rendering Index:
CRI ≥ 70, SDCM ≤ 3

Illuminazione intelligente / Smart Lighting:
mezzanotte virtuale. Su richiesta DALI, ZHAGA, CLO, PLC, telegestione wireless
virtual midnight. On request DALI, ZHAGA, CLO, PLC, wireless telemanagement

MATERIALI / MATERIALS

Corpo e sistemi di fissaggio / Body and fitting system:
pressofusione di lega d'alluminio UNI EN AB 47100 (contenuto rame < 1%) / die-cast aluminum alloy UNI EN AB 47100 (copper content < 1%)

Schermo / Screen:
vetro piano temprato / tempered flat glass

Gruppo ottico / Optical unit:
lenti PMMA ad alta trasparenza
high-transparency PMMA lenses

Finitura / Finish:
fosfocromatazione e verniciatura in polveri di poliestere realizzata in 16 fasi per la miglior resistenza agli agenti atmosferici / phospho-chromatation treated and polyester powder-coated in 16 phases to increase weather resistance

COLORI / COLOURS

● SABLÉ 100 NOIR

ECO-CENTRIC LIGHTING (ECL)

(ONLY FOR STREET OPTICS)

BLUE FREE LIGHT:

PC-AMBER 0,7% ΣR ($\lambda < 500\text{NM}$) – CRI 40
1800 K 4,3% ΣR ($\lambda < 500\text{NM}$) – CRI 70

SWITCHABLE WHITE LIGHT:

1800K / 3000K

CARATTERISTICHE / FEATURES

Peso massimo / Max weight:
3,5 kg (small), 7,5 kg (medium)

Alimentazione elettronica / Electronic power supply:
inclusa / included

Resistenza sovratensioni / Surge Protection Device:
10 kV MC/MD

Precablaggio / Pre-wiring:
prodotto pre-cablato con cavo e connettore
pre-wired product with cable and connector

Installazione / Installation:
testa palo, lato palo, sospensione braccio, sospensione tesata, parete, sottoportico
post top, pole side, suspension arm, string suspension, wall, arcade





ODENA
Spain



KIEV
Ukraine



NERVI
Italy

CAPACCIO PAESTUM
Italy



OTTICHE / OPTICS

LT-C1 Cycle Path
L / H = 0,5

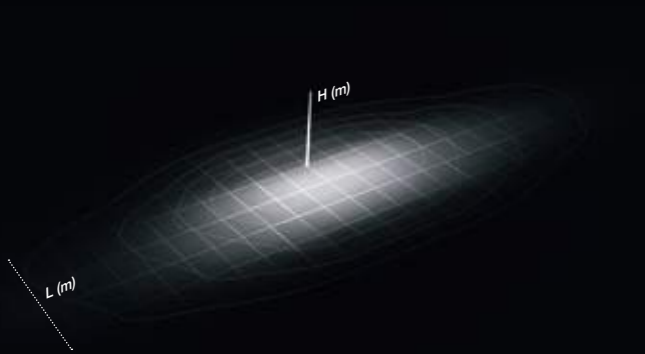

LA-03 Wide Street
L / H = 1,25

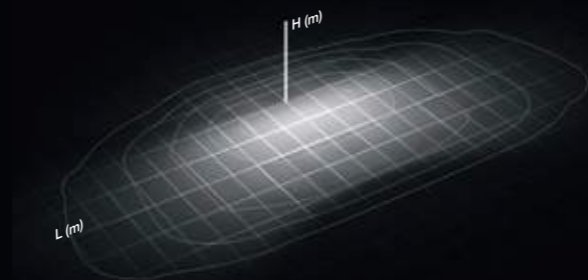

ECL

ST-02 Narrow Street
L / H = 0,75

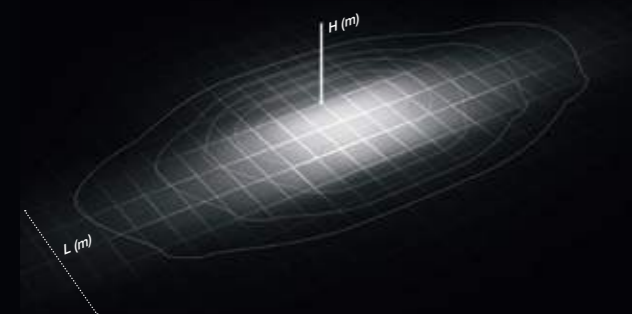

ECL

LT-64 Asymmetric Beam with backlight
L / H = 2

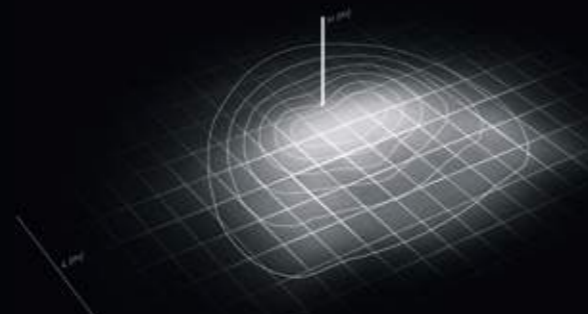

ECL

ME-05 Medium Street
L / H = 1

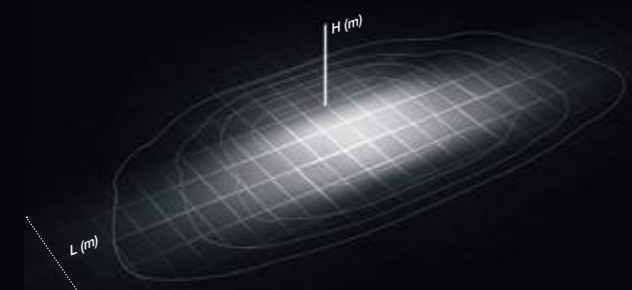

ECL

RS-02 Rotosymmetric Beam
L / H = 2

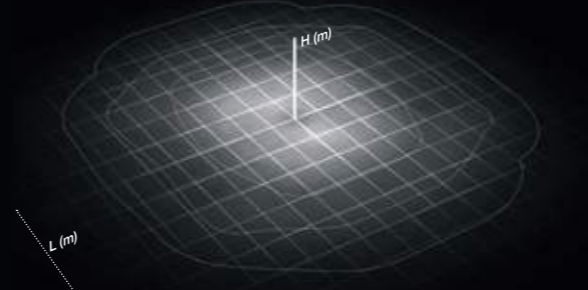

Kosmos
Testa palo / Post top

DATI TECNICI / TECHNICAL DATA

Installazione / Installations:
con accessorio 06KS901C0 su pali Ø 76 mm, con riduzione Ø 60 mm / with accessory 06KS901C0 on poles Ø 76 mm, with reduction Ø 60 mm

MEDIUM

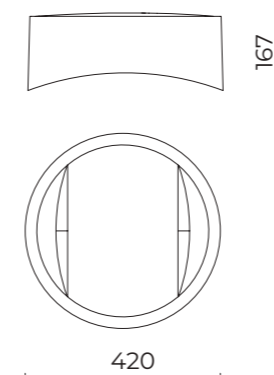

TEMPERATURA COLORE / COLOUR TEMPERATURE

- 2200 K
- 2700 K
- 3000 K
- 4000 K

ACCESSORI / ACCESSORIES

06KS901C0
B81 - Chela testa palo, innesto
H 90 mm / Arm for post top,
fastening part H 90 mm

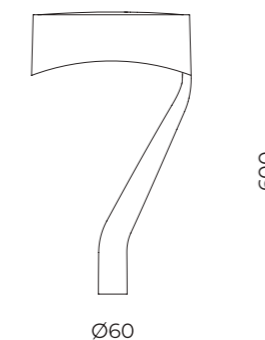

OTTICHE / OPTICS

LT-C1 Cycle Path
L / H = 0,5

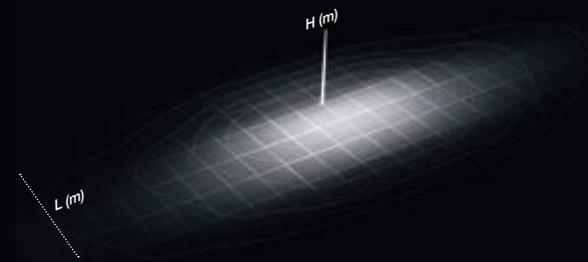

PB-01 Low Pole
L / H = 2

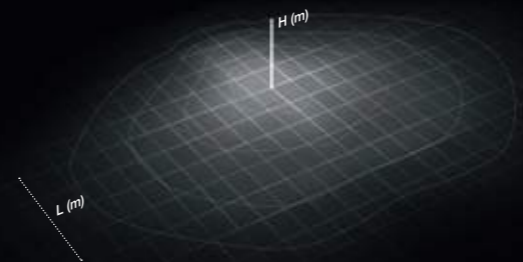

ST-02 Narrow Street
L / H = 0,75

ECL

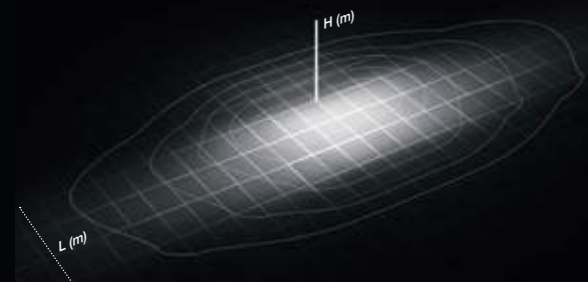

AP-D2 Pedestrian Crossing

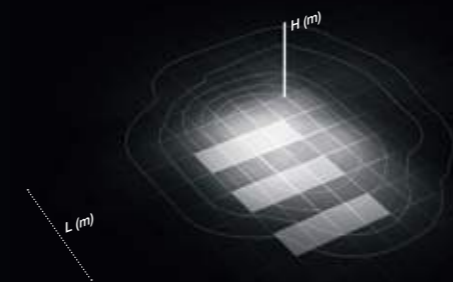

ME-05 Medium Street
L / H = 1

ECL

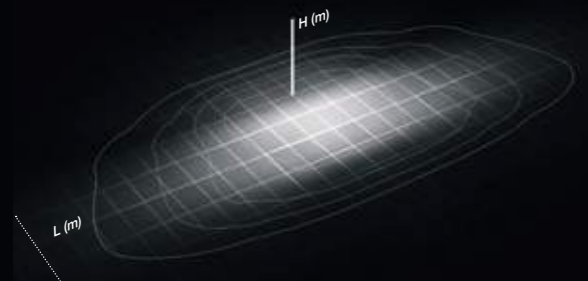

AP-S2 Pedestrian Crossing

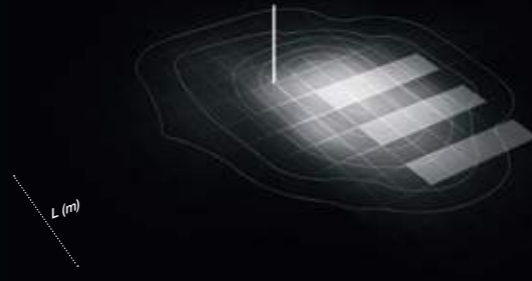

LA-03 Wide Street
L / H = 1,25

ECL

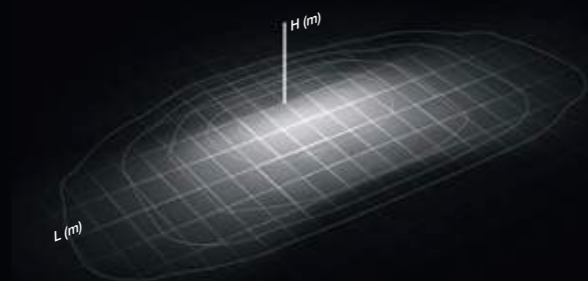

LT-64 Asymmetric Beam with backlight
L / H = 2

ECL

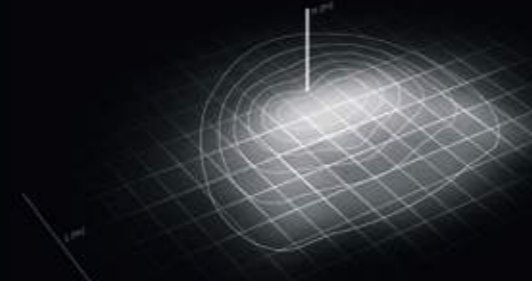

Lato palo / Pole side



DATI TECNICI / TECHNICAL DATA

Installazione / Installation:
con accessori, su pali Ø 60 - 76 - 102 mm
with accessories, on poles Ø 60 - 76 - 102 mm

Inclinazione / Inclination:
regolazione continua -10° ÷ +190° (in step da 5°)
continuous adjustment -10° ÷ +190° (step 5°)

SMALL

MEDIUM

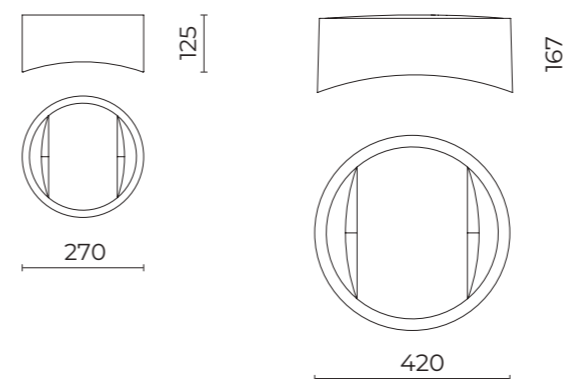

TEMPERATURA COLORE
COLOUR TEMPERATURE

- 2200 K
- 2700 K
- 3000 K
- 4000 K



Kosmos
Lato palo / Pole side

ACCESSORI / ACCESSORIES

KOSMOS SMALL

06ND901Y0
Diffusore policarbonato trasparente
Transparent polycarbonate diffuser

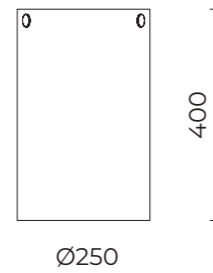

KOSMOS SMALL - MEDIUM

06KS904C0
B84 - Snodo per bracci
Joint for arms

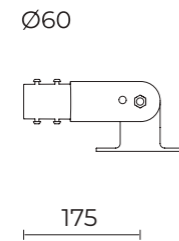

06KS906C0
B86 - Giunto testa palo, codolo H 90 mm
Joint for post top, fastening part H 90 mm

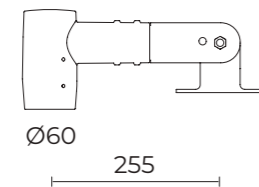

06KS907C0
B87 - Braccio per pali
Arm for poles

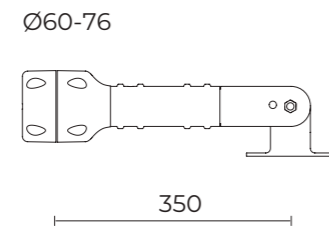

06KS912C0
B92 - Braccio per pali
Arm for poles

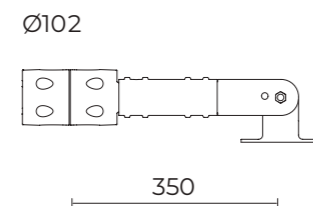

KOSMOS SMALL - MEDIUM

06KS908C0
B88 - Braccio per pali
Arm for poles

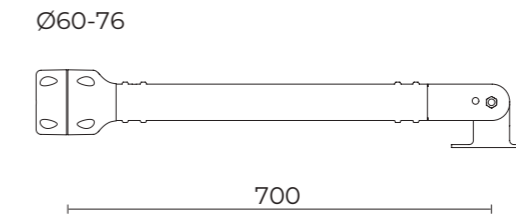

06KS913C0
B93 - Braccio per pali
Arm for poles

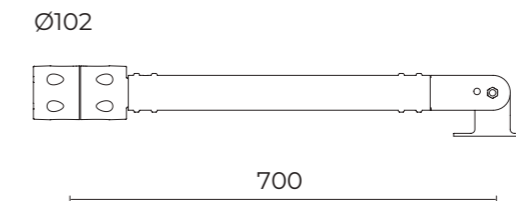

06KS910C0
B90 - Braccio doppio per pali
Double arm for poles

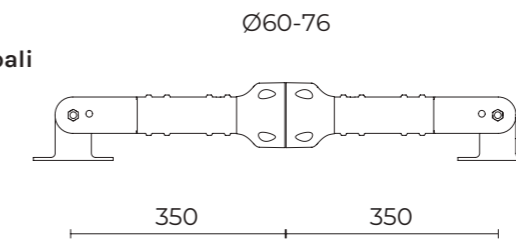

06KS914C0
B94 - Braccio doppio per pali
Double arm for poles

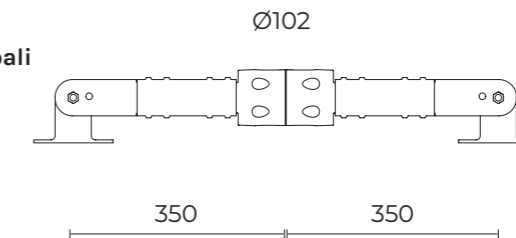

06KS911C0
B91 - Braccio doppio per pali
Double arm for poles

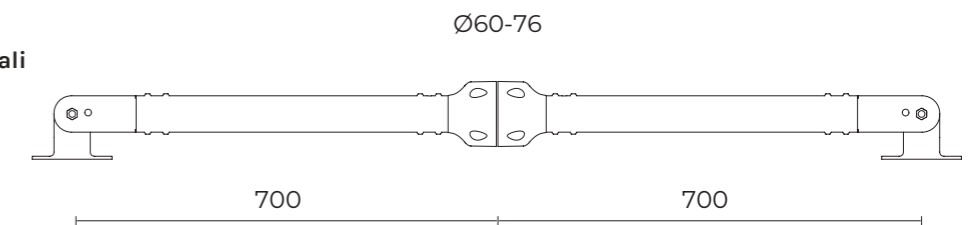

06KS915C0
B95 - Braccio doppio per pali
Double arm for poles

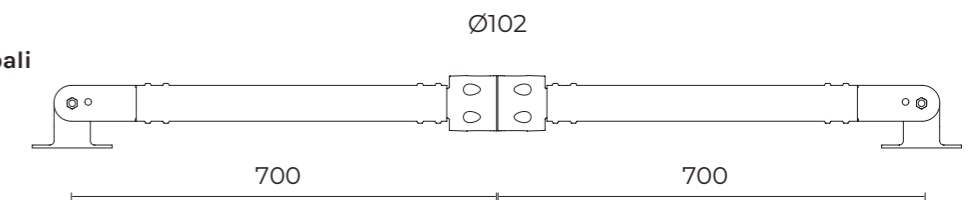



OTTICHE / OPTICS

LT-C1 Cycle Path
L / H = 0,5

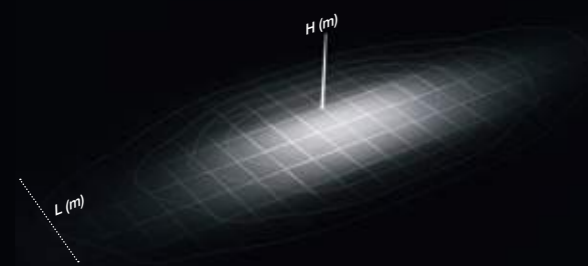

PB-01 Low Pole
L / H = 2

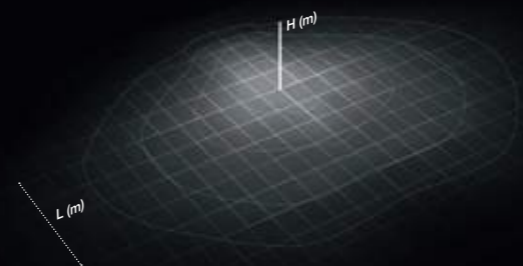

ST-02 Narrow Street
L / H = 0,75

ECL

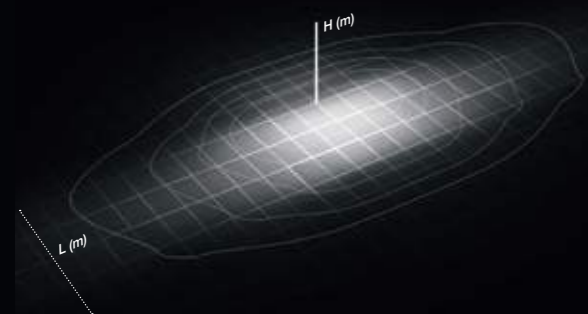

AP-D2 Pedestrian Crossing

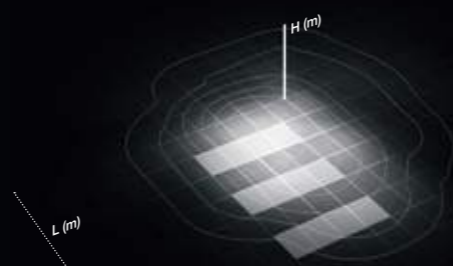

ME-05 Medium Street
L / H = 1

ECL

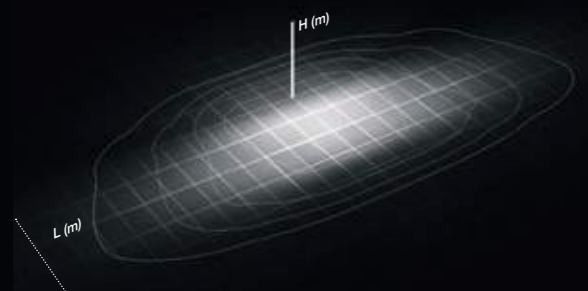

AP-S2 Pedestrian Crossing

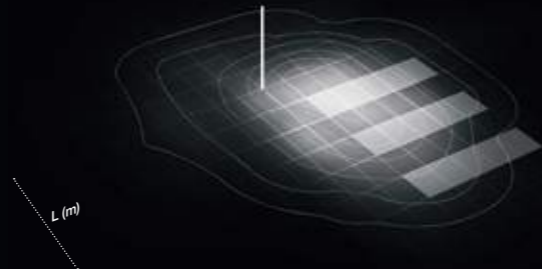

LA-03 Wide Street
L / H = 1,25

ECL

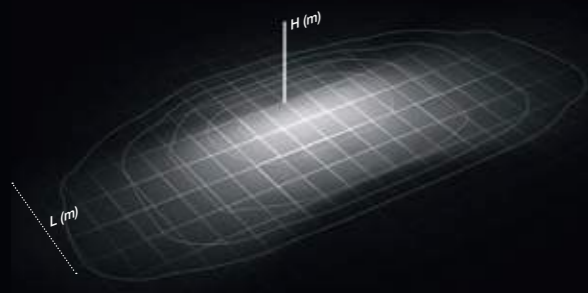

LT-64 Asymmetric Beam with backlight
L / H = 2

ECL

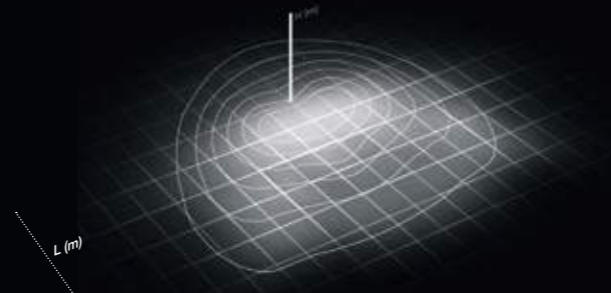

Sospensione braccio / Arm suspension

DATI TECNICI / TECHNICAL DATA

Installazione / Installation:
con accessorio 06KS903C0 su bracci
per pali Ø 102 mm
with accessory 06KS903C0 on arms
for poles Ø 102 mm



SMALL

MEDIUM

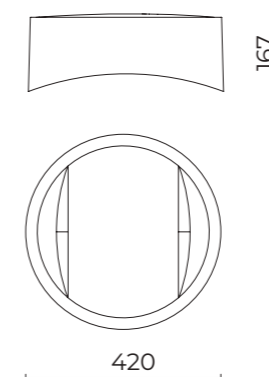
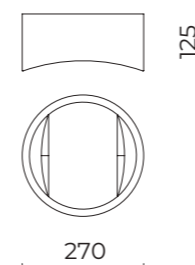

TEMPERATURA COLORE
COLOUR TEMPERATURE

- 2200 K
- 2700 K
- 3000 K
- 4000 K



Kosmos

Sospensione braccio / Arm suspension

ACCESSORI / ACCESSORIES

06KS903C0
B79 - Kit fissaggio su bracci pastorali
Fastening kit on curved arms

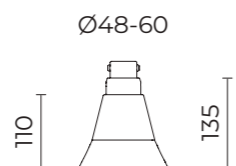

01AK935C0
B15 - Braccio pastorale per pali
Curved arm for poles

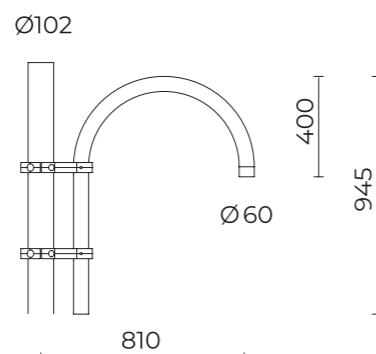

01AK936C0
B16 - Braccio pastorale doppio per pali
Double curved arm for poles

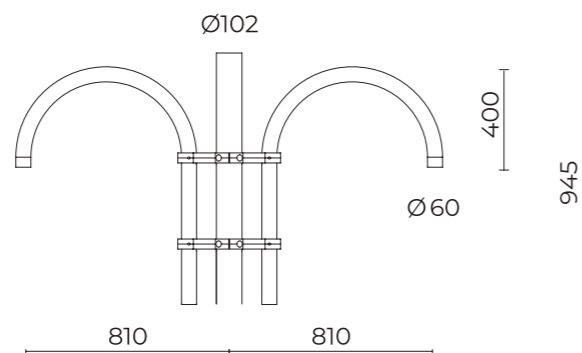

01AK950C0
B1-P - Braccio pastorale parete
Curved arm for wall

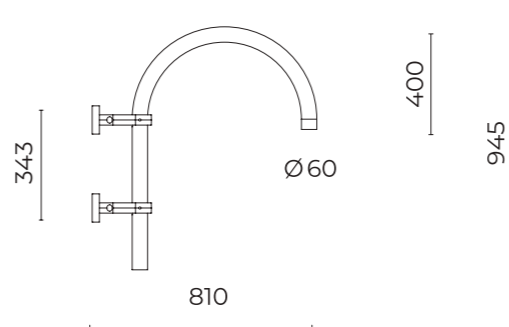

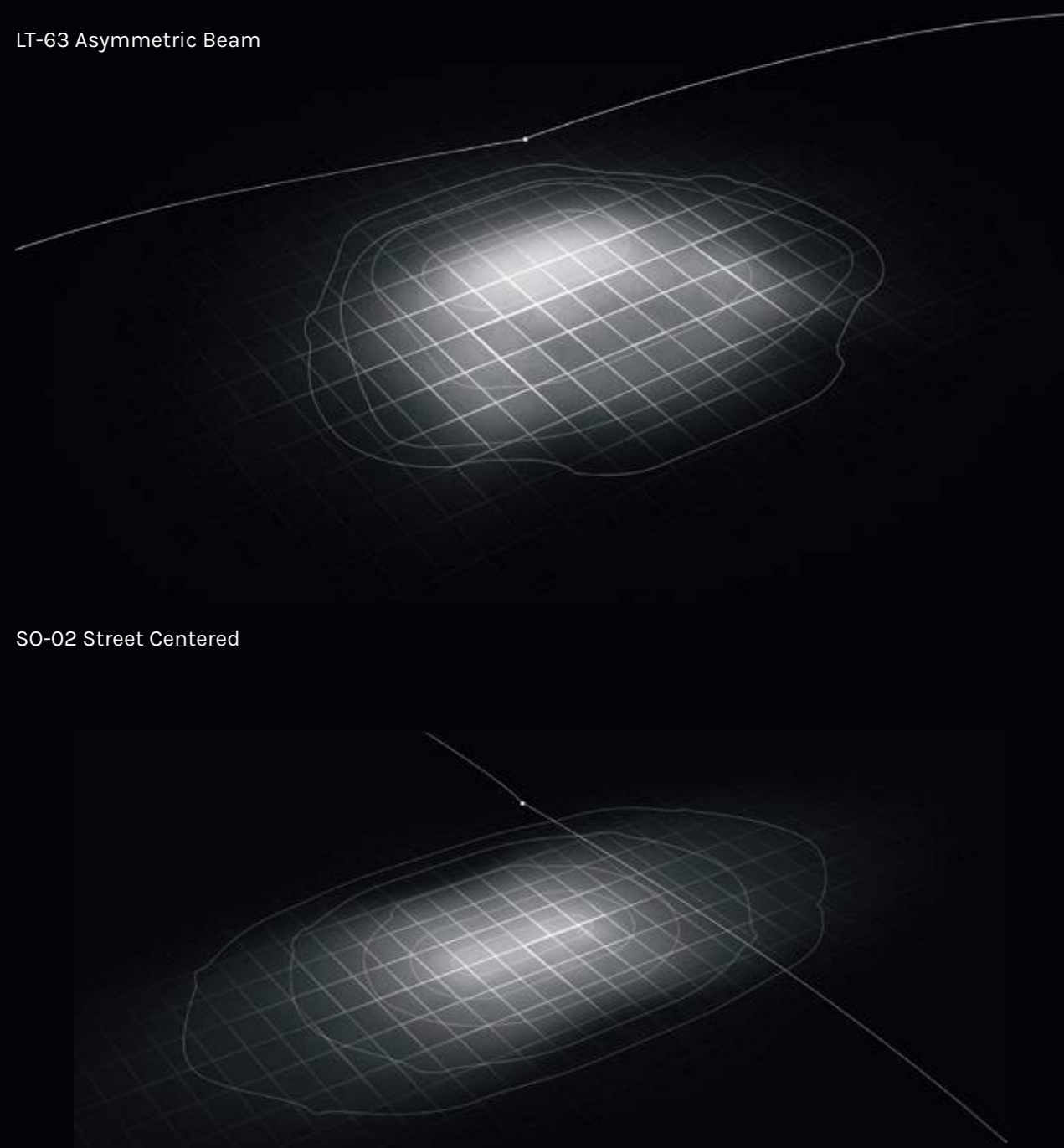

Kosmos
Sospensione tesata
String suspension

DATI TECNICI / TECHNICAL DATA

Installazione / Installation:
sospensione tesata / string suspension

Inclinazione / Inclination:
orizzontale $\pm 15^\circ$ / horizontal $\pm 15^\circ$

Orientabilità / Adjustability:
 $0^\circ + 360^\circ$

**TEMPERATURA COLORE
COLOUR TEMPERATURE**

- 2200 K
- 3000 K
- 4000 K

SMALL

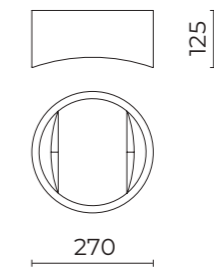

MEDIUM

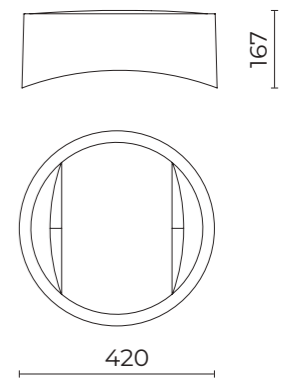

ACCESSORI / ACCESSORIES

06KS902C0
B80 - Kit sospensione su
fune tesata $\varnothing 6 \div 12$ mm
Suspension kit for string $\varnothing 6 \div 12$ mm

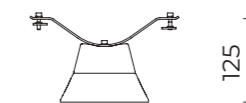

06ND901Y0
Diffusore policarbonato trasparente
Kosmos small
Transparent polycarbonate diffuser
Kosmos small

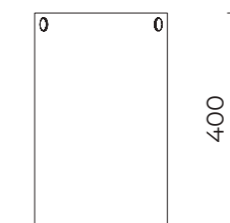

$\varnothing 250$



OTTICHE / OPTICS

LT-C1 Cycle Path
L / H = 0,5

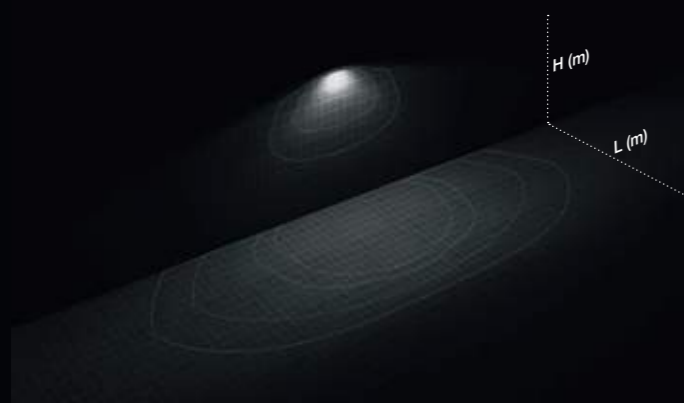

LA-03 Wide Street
L / H = 1,25

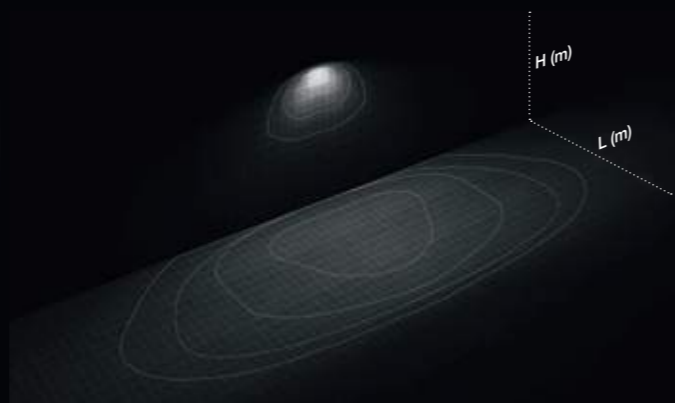

ST-02 Narrow Street
L / H = 0,75

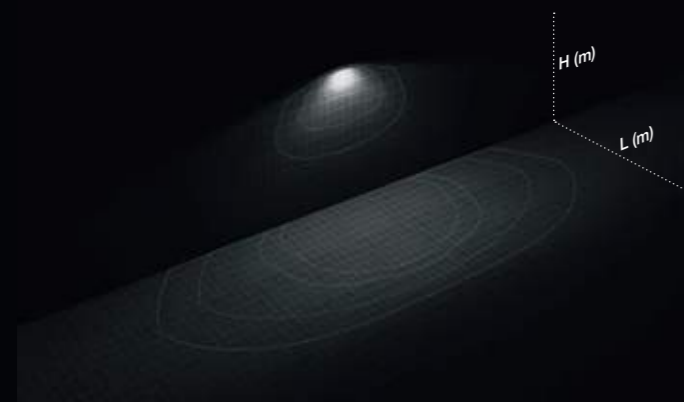

PB-01 Low Pole
L / H = 2

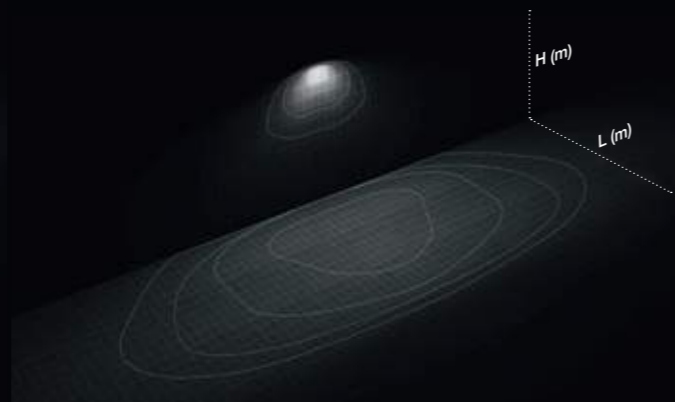

ME-05 Medium Street
L / H = 1

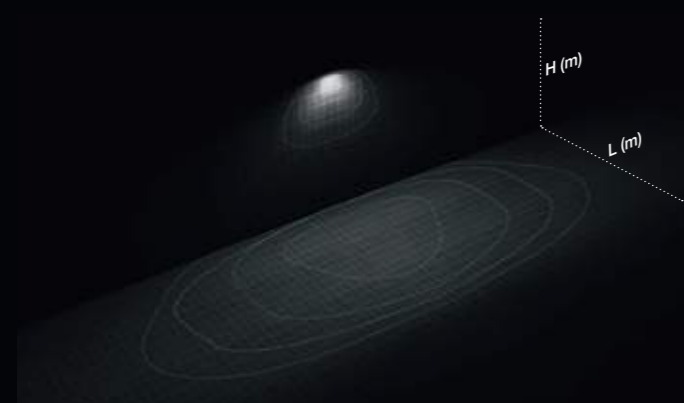

LT-63 Asymmetric Beam
L / H = 2

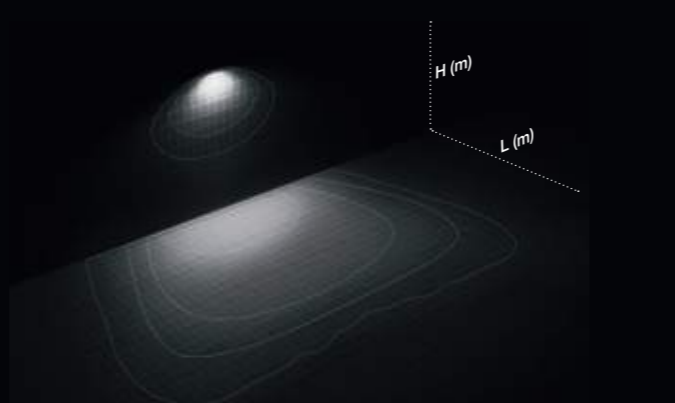

Kosmos
Parete / Wall

DATI TECNICI / TECHNICAL DATA

Installazione / Installation:
su bracci a parete / on wall-mounted arms

Inclinazione / Inclination:
regolazione -10° ÷ +190° (in step da 5°)
adjustment -10° ÷ +190° (step 5°)



TEMPERATURA COLORE
COLOUR TEMPERATURE

- 3000 K
- 4000 K

SMALL

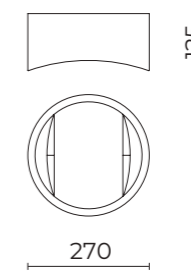

MEDIUM

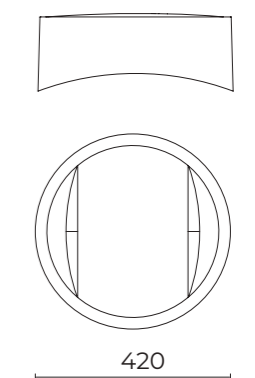

ACCESSORI / ACCESSORIES

06KS905C0
B85-P - Braccio parete
Arm for wall-mounting

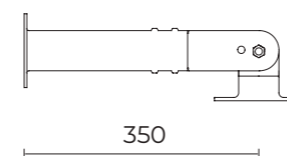

06KS904C0
B84 - Snodo per bracci
Joint for arms

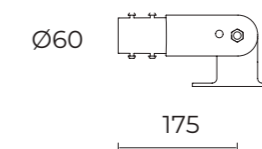

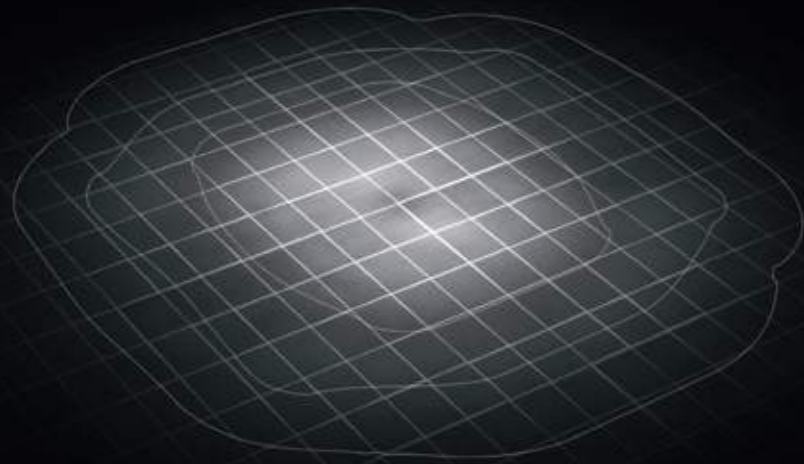

Kosmos
Soffitto / Ceiling

Cariboni Group

DATI TECNICI / TECHNICAL DATA

Installazione / Installation:
soffitto, sottoportico
ceiling, arcade

Inclinazione / Inclination:
regolazione -10° ÷ +190° (in step da 5°)
adjustment -10° ÷ +190° (step 5°)



TEMPERATURA COLORE
COLOUR TEMPERATURE

● 3000 K

○ 4000 K

SMALL

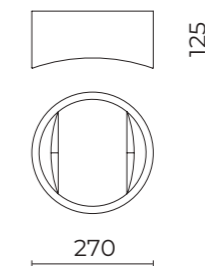

MEDIUM

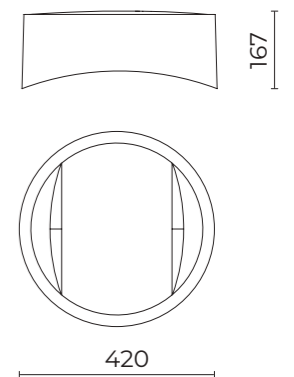

ACCESSORI / ACCESSORIES

06KS905C0
B85-P - Attacco soffitto, sottoportico
Ceiling or arcade mounted

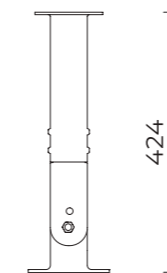

06ND901Y0
Diffusore policarbonato trasparente Kosmos small
Transparent polycarbonate diffuser Kosmos small

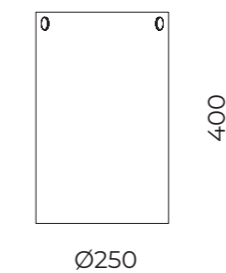

LT-63 Asymmetric Beam
L / H = 2

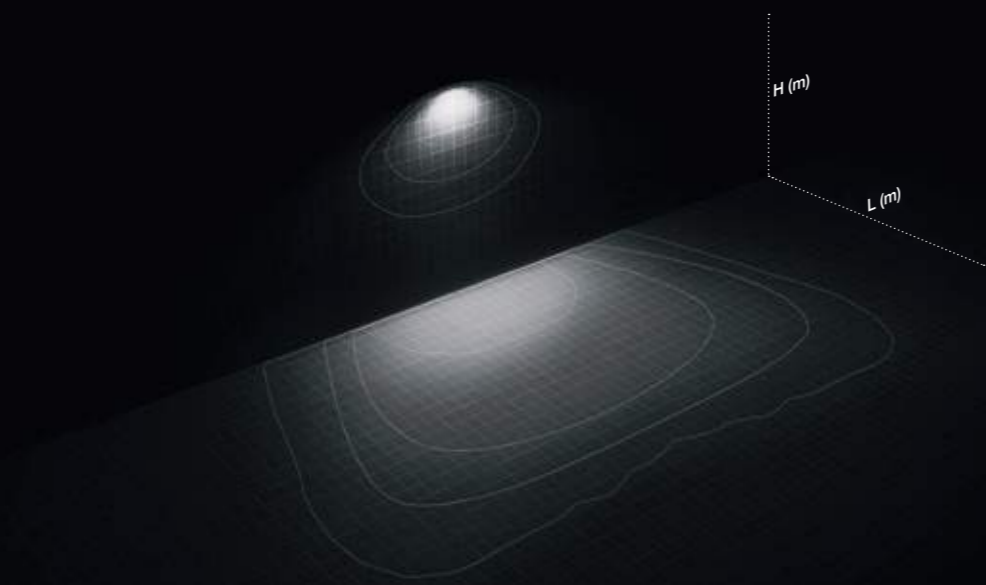

LR-20 Medium Beam

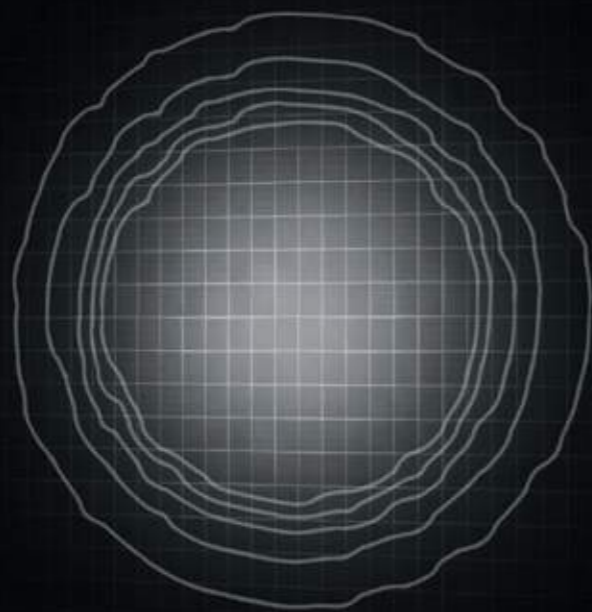

Kosmos Flood

DATI TECNICI / TECHNICAL DATA

Peso massimo / Max weight:
4,2 kg (small), 9,2 kg (medium)

Installazione / Installation:
superfici orizzontali e verticali
horizontal and vertical surfaces

Inclinazione / Inclination:
regolazione continua -25° ÷ +205°
continuous adjustment -25° ÷ +205°

SMALL

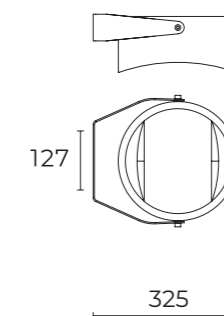

MEDIUM

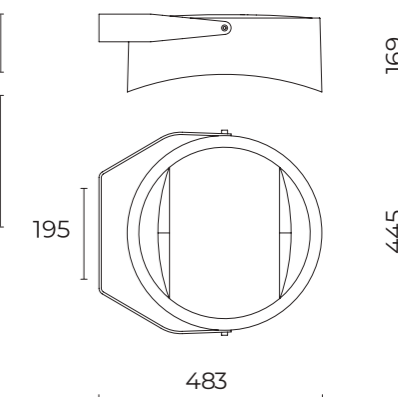

TEMPERATURA COLORE COLOUR TEMPERATURE

- 2200 K
- 3000 K
- 4000 K



LT-63 Asymmetric Beam
L / H = 2

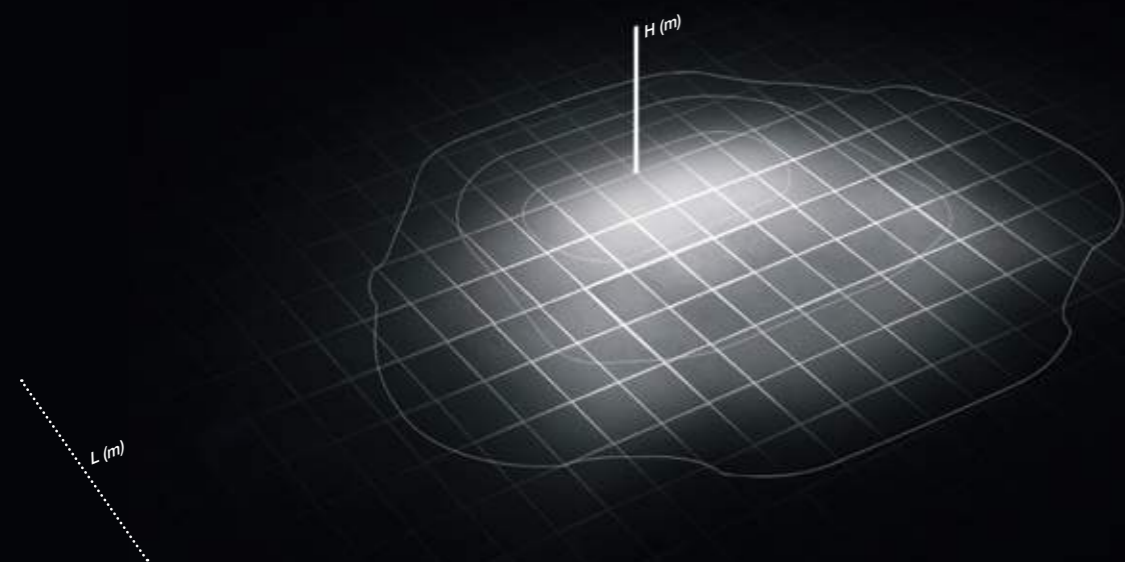

LR-20 Medium Beam

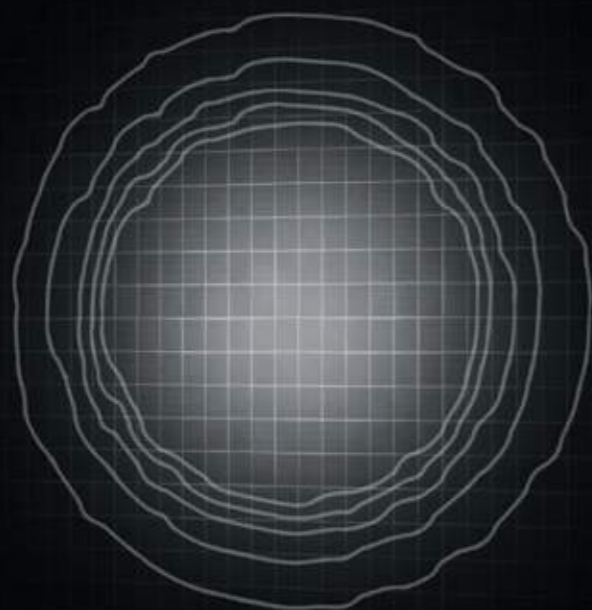

Kosmos
Flood

DATI TECNICI / TECHNICAL DATA

Installazione / Installation:
con accessori su pali Ø 60 - 76 - 102 mm
with accessories on poles Ø 60 - 76 - 102 mm

Inclinazione / Inclination:
regolazione continua -25° ÷ +205°
continuous adjustment -25° ÷ +205°

TEMPERATURA COLORE
COLOUR TEMPERATURE

- 2200 K
- 3000 K
- 4000 K

ACCESSORI / ACCESSORIES

06KS916C0
B78 - Kit attacco staffa-palo
Attachment kit for bracket-pole

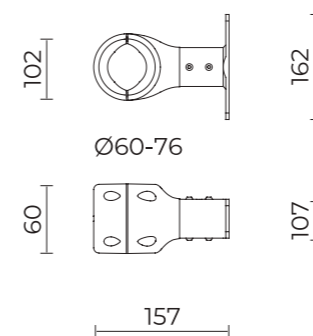

06KS917C0
B97 - Kit attacco staffa-palo
Attachment kit for bracket-pole

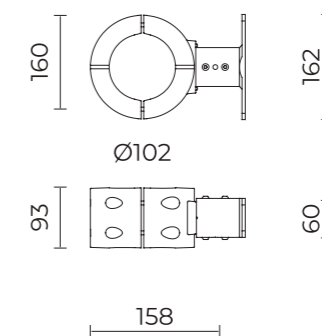

AGATHOS



AGATHOS è una lanterna dalle forme tradizionali ma progettata specificatamente per alloggiare la più innovativa tecnologia LED.

AGHATOS is a lantern with traditional shapes but specifically designed to house the most innovative led technology.



MONZA
Italy



PORTO VENERE
Italy



BUSSETO
Italy



TURKU
Finland

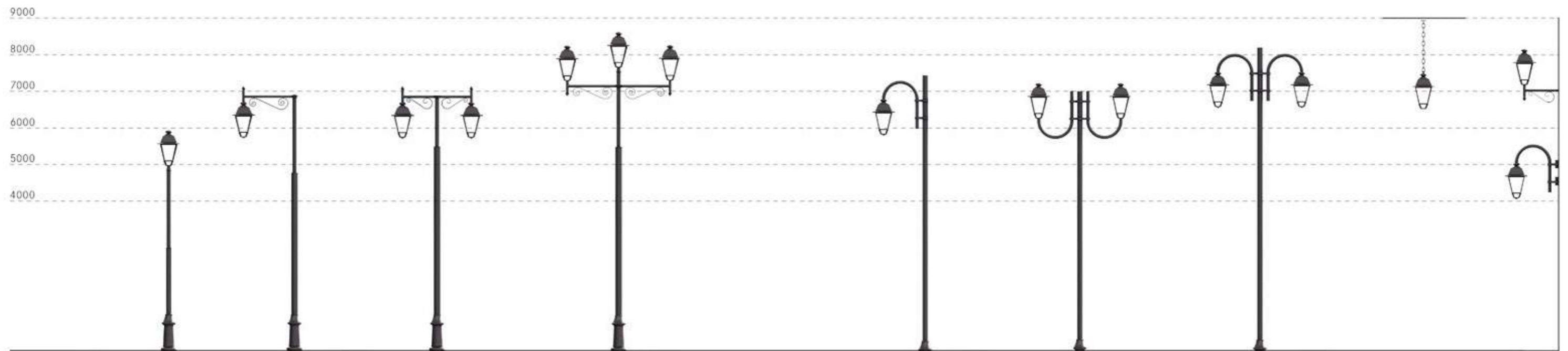



DATI PRESTAZIONALI / PERFORMANCE DATA

Flusso apparecchio / Fitting flux:
1355 (1800 K) - 10835 lm

Potenza apparecchio / Fitting power:
12 - 78 W

Indice di resa cromatica / Colour Rendering Index:
CRI ≥ 70, SDCM ≤ 3

Illuminazione intelligente / Smart Lighting:
mezzanotte virtuale. Su richiesta DALI, CLO, PLC,
telegestione wireless
virtual midnight. On request DALI, CLO, PLC,
wireless telemanagement

MATERIALI / MATERIALS

Corpo e sistemi di fissaggio / Body and fitting system:
pressofusione di lega d'alluminio UNI EN AB 47100
(contenuto rame < 1%) / die-cast aluminum alloy UNI EN
AB 47100 (copper content < 1%)

Schermo / Screen:
vetro piano temprato / tempered flat glass

Gruppo ottico / Optical unit:
lenti PMMA ad alta trasparenza
high-transparency PMMA lenses

Finitura / Finish:
fosfocromatazione e verniciatura in polveri di poliestere
realizzata in 16 fasi per la miglior resistenza agli
agenti atmosferici / phospho-chromatation treated
and polyester powder-coated in 16 phases to increase
weather resistance

TEMPERATURA COLORE COLOUR TEMPERATURE

- 2200 K
- 2700 K
- 3000 K
- 4000 K

ECO-CENTRIC LIGHTING (ECL) (ONLY FOR STREET OPTICS)

BLUE FREE LIGHT:
PC-AMBER 0,7% ΣR ($\lambda < 500\text{NM}$) – CRI 40
1800 K 4,3% ΣR ($\lambda < 500\text{NM}$) – CRI 70

SWITCHABLE WHITE LIGHT:
1800K / 3000K

COLORI / COLOURS

- SABLÉ 100 NOIR

CARATTERISTICHE / FEATURES

Peso massimo / Max weight:
8 kg

Alimentazione elettronica / Electronic power supply:
inclusa / included

Resistenza sovratensioni / Surge Protection Device:
10 kV MC/MD

Installazione / Installation:
testa palo, lato palo, sospensione braccio, parete,
sottoportico / post top, pole side, arm suspension,
wall, arcade



OTTICHE / OPTICS

LT-C1 Cycle Path
L / H = 0,5

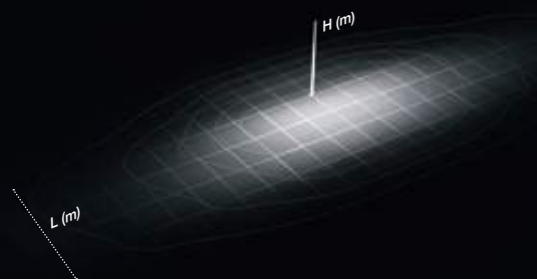

LT-64 Asymmetric Beam with backlight ECL
L / H = 2

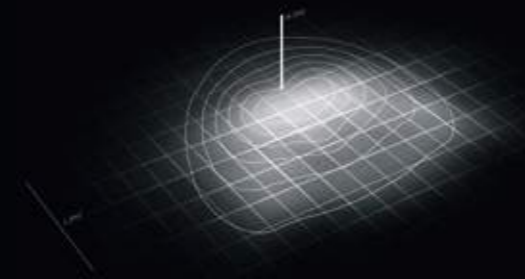

ST-02 Narrow Street ECL
L / H = 0,75

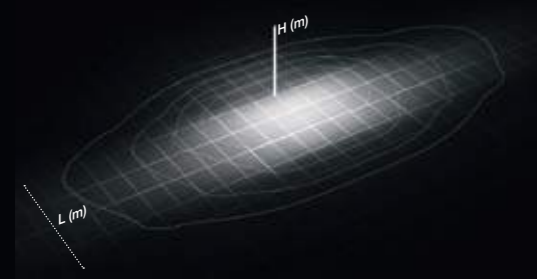

F&B ST-02 + LA-03 Front & Back
L / H = 0,75 + 1,25

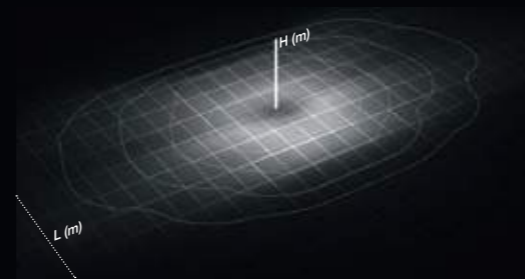

LA-03 Wide Street
L / H = 1,25

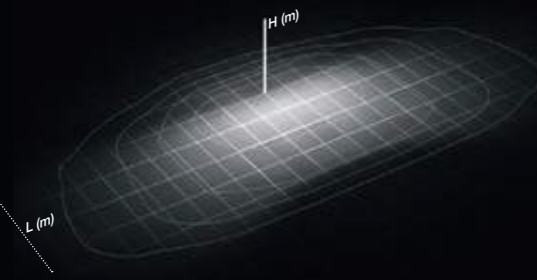

RS-02 Rotosymmetric Beam ECL
L / H = 2

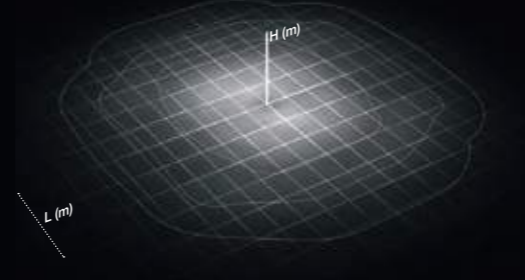

Agathos
Testa palo / Post top

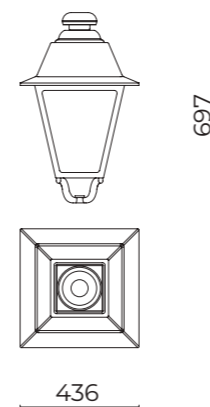

DATI TECNICI / TECHNICAL DATA

Installazione / Installation:
pali con attacco 3/4" GAS maschio, pali cima Ø 60 mm
innesto H 90 mm con accessorio 01AG901CO / poles with
male 3/4" GAS connection, poles with post top Ø 60 mm and
fastening part H 90 mm with accessory 01AG901CO

ACCESSORI / ACCESSORIES

01AG900CO
Kit fissaggio per pali con
attacco 3/4" GAS femmina
Fastening kit on poles with
female 3/4" GAS

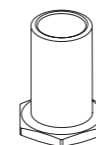

01AG901CO
Kit testa palo codolo H 90 mm
Fastening kit post top H 90 mm



Ø60



OTTICHE / OPTICS

ST-02 Narrow Street
L / H = 0,75

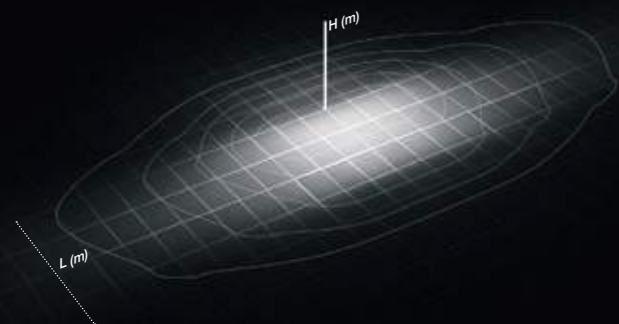

LT-64 Asymmetric Beam with backlight
L / H = 2

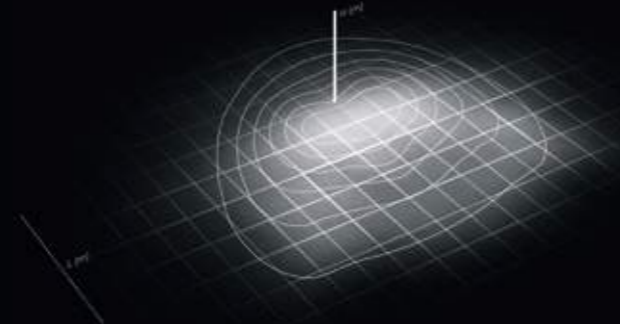

LA-03 Wide Street
L / H = 1,25

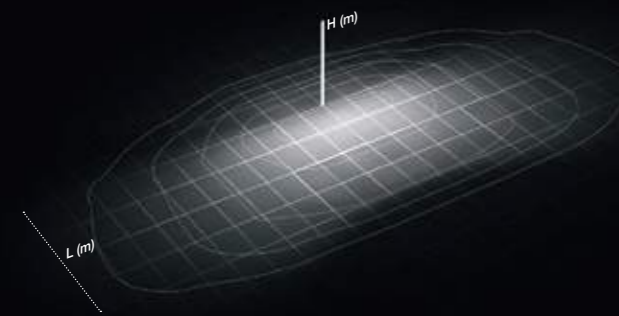

Agathos

Lato palo / Pole side

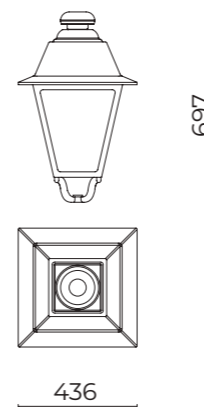

DATI TECNICI / TECHNICAL DATA

Installazione / Installation:
su bracci con attacco 3/4" GAS maschio
on arms with male 3/4" GAS connection

ACCESSORI / ACCESSORIES

01AG900CO
Kit fissaggio per bracci UP con attacco 3/4" GAS femmina
Fastening kit on UP arms with female 3/4" GAS

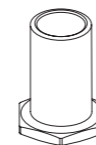

Agathos

Lato palo / Pole side

BRACCI / ARMS

01AG910CO
B60 - Braccio pastorale UP
Curved arm UP

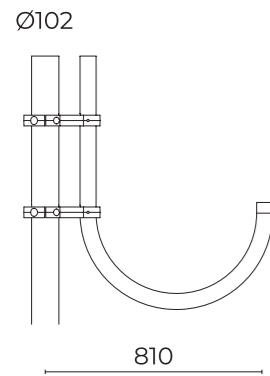

01AG911CO
B61 - Braccio pastorale doppio UP
Double curved arm UP

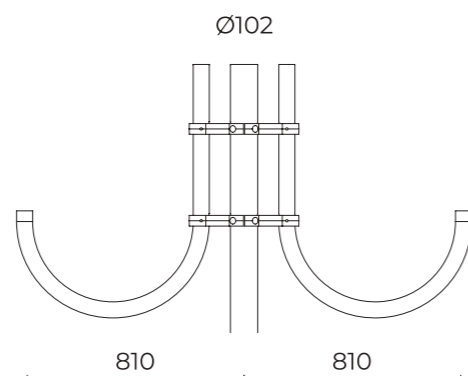

01AG914CO
B64 - Braccio UP
Arm UP

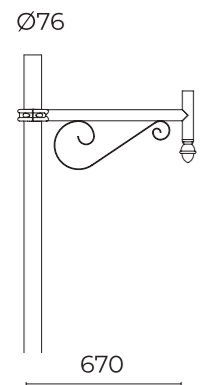

01AG918CO
B68 - Braccio doppio UP
Double arm UP

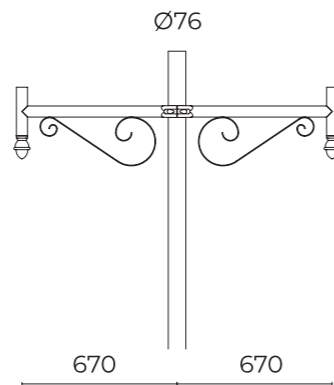

01AG915CO
B65 - Braccio UP
Arm UP

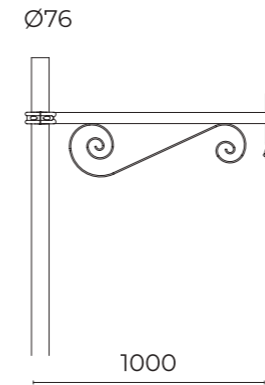

01AG919CO
B69 - Braccio doppio UP
Double arm UP

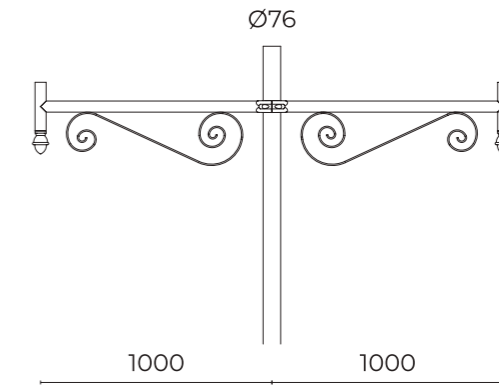

ACCESSORI / ACCESSORIES

01AK970CO
Collarino per palo
Collar for pole

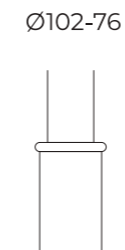

01AK971CO
Collarino per palo
Collar for pole

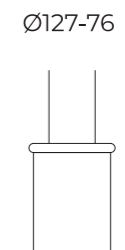

01AK972CO
Basamento basso
Low base

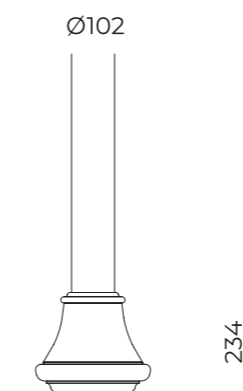

01AK973CO
Basamento alto
High base

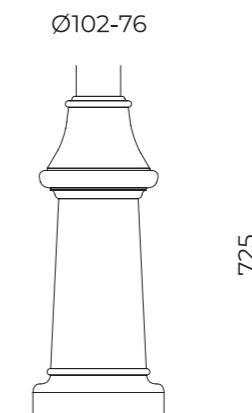

01AK974CO
Basamento alto
High base

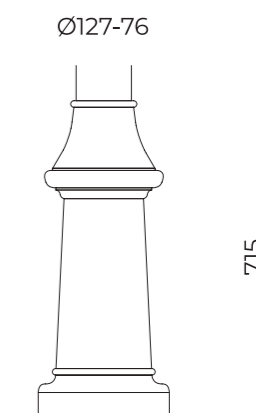

ST-02 Narrow Street
L / H = 0,75

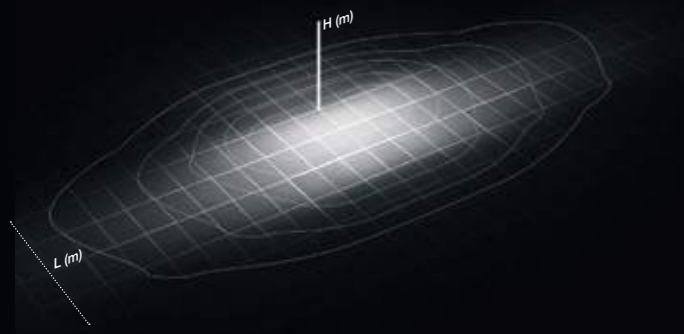

LT-64 Asymmetric Beam with backlight
L / H = 2

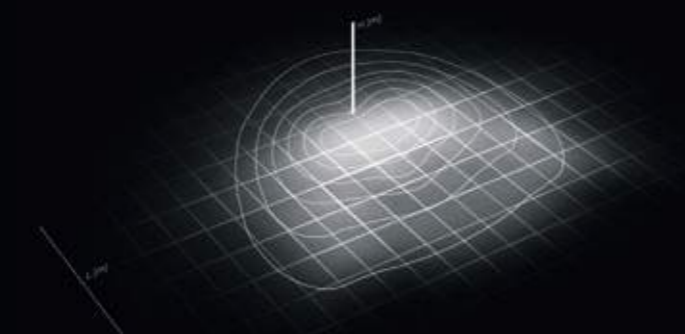

LA-03 Wide Street
L / H = 1,25

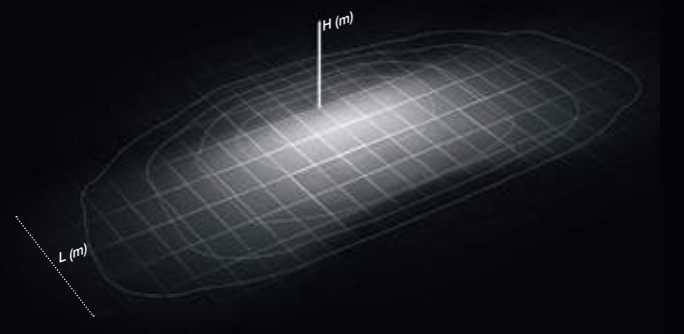

Agathos
Sospensione braccio
Arm suspension

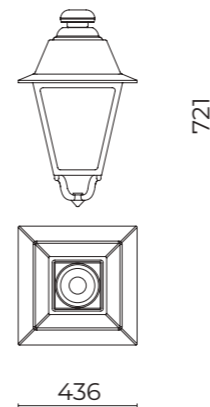

DATI TECNICI / TECHNICAL DATA

Installazione / Installation:
su bracci con attacco 3/4" GAS femmina
on arms with female 3/4" GAS connection



Agathos

Sospensione braccio / Arm suspension

BRACCI / ARMS

01AG910CO
B62 - Braccio pastorale DOWN
 Curved arm DOWN

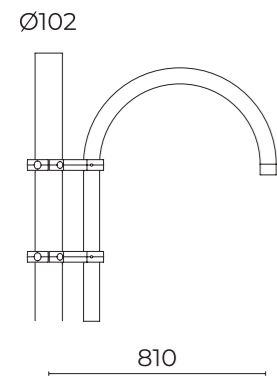

01AG911CO
B63 - Braccio pastorale doppio DOWN
 Double curved arm DOWN

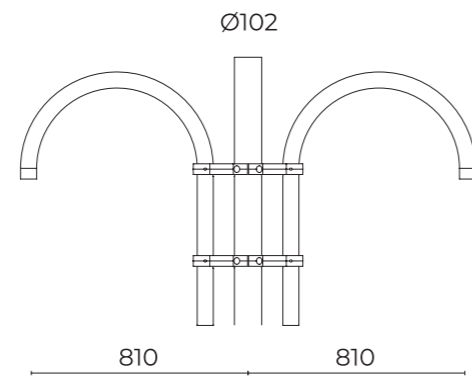

01AG914CO
B66 - Braccio DOWN
 Arm DOWN

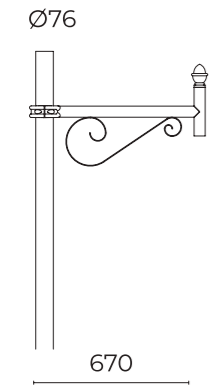

01AG918CO
B70 - Braccio doppio DOWN
 Double arm DOWN

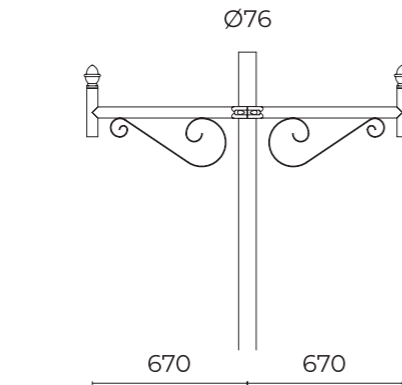

01AG915CO
B67 - Braccio DOWN
 Arm DOWN

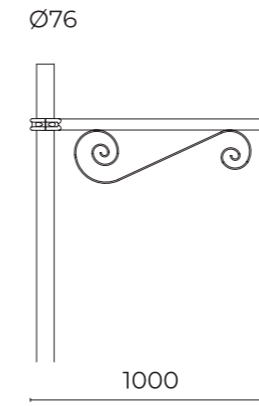

01AG919CO
B71 - Braccio doppio DOWN
 Double arm DOWN

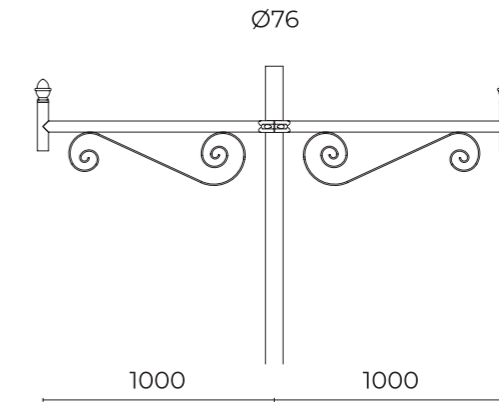

ACCESSORI / ACCESSORIES

01AK970CO
Collarino per palo
 Collar for pole

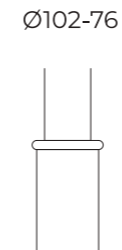

01AK971CO
Collarino per palo
 Collar for pole

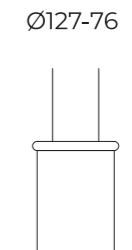

01AK972CO
Basamento basso
 Low base

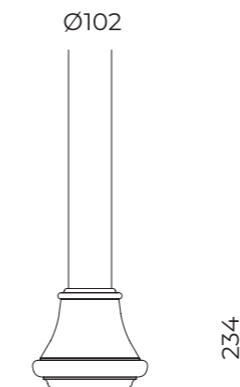

01AK973CO
Basamento alto
 High base

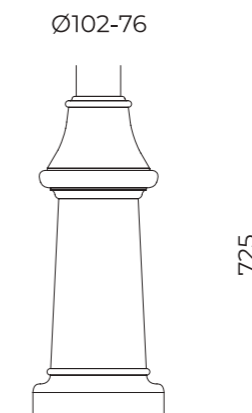

01AK974CO
Basamento alto
 High base

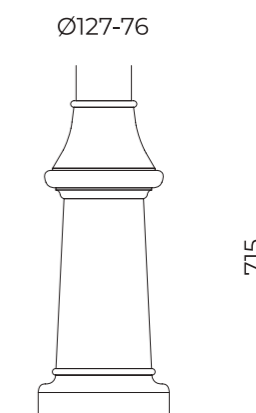

OTTICHE / OPTICS

ST-02 Narrow Street
L / H = 0,75

LT-63 Asymmetric Beam
L / H = 2

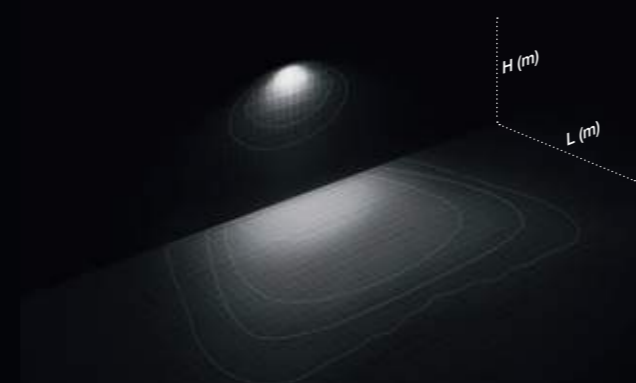
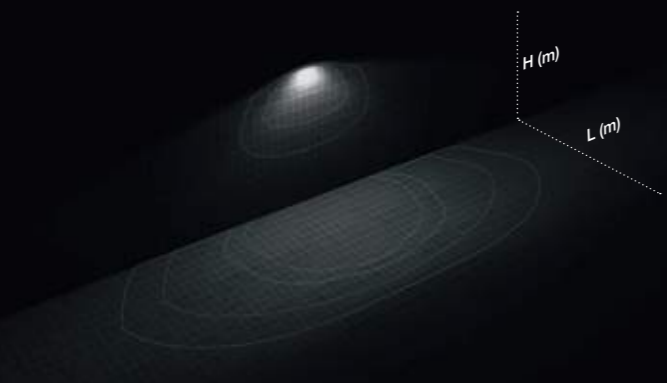

LA-03 Wide Street
L / H = 1,25

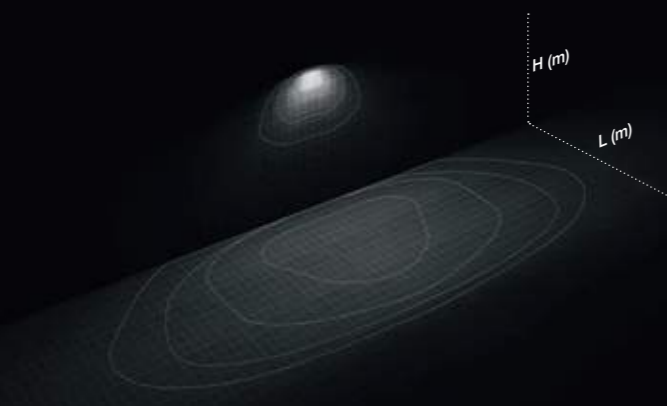

Agathos
Parete / Wall

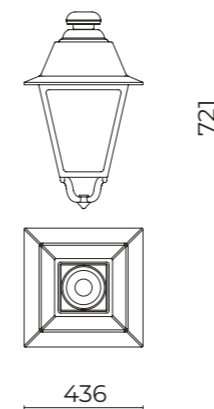

DATI TECNICI / TECHNICAL DATA

Installazione / Installation:
su bracci a parete / on wall-mounted arms

ACCESSORI / ACCESSORIES

01AG900CO
Kit fissaggio per bracci UP con attacco 3/4" GAS femmina
Fastening kit on UP arms with female 3/4" GAS

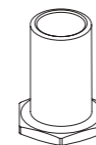

Agathos
Parete / Wall

BRACCI / ARMS

01AG922CO
B60-P - Braccio
pastorale UP
Bracket UP

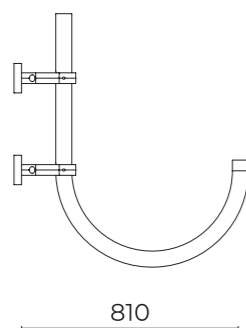

01AG923CO
B62-P - Braccio
pastorale DOWN
Bracket DOWN

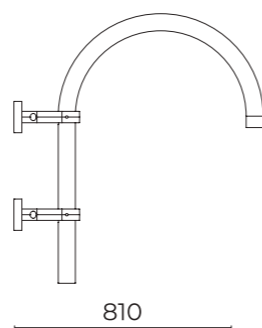

01AG924CO
B64-P - Braccio UP
Bracket UP

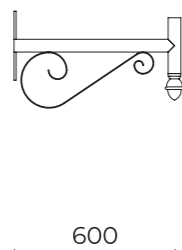

01AG925CO
B65-P - Braccio UP
Bracket UP

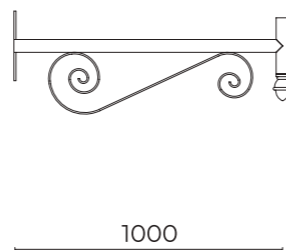

01AG926CO
B66-P - Braccio DOWN
Bracket DOWN

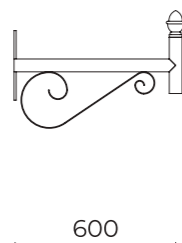

01AG927CO
B67-P - Braccio DOWN
Bracket DOWN

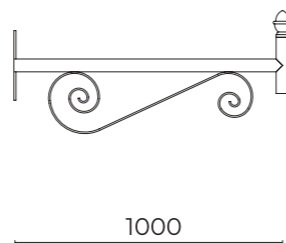

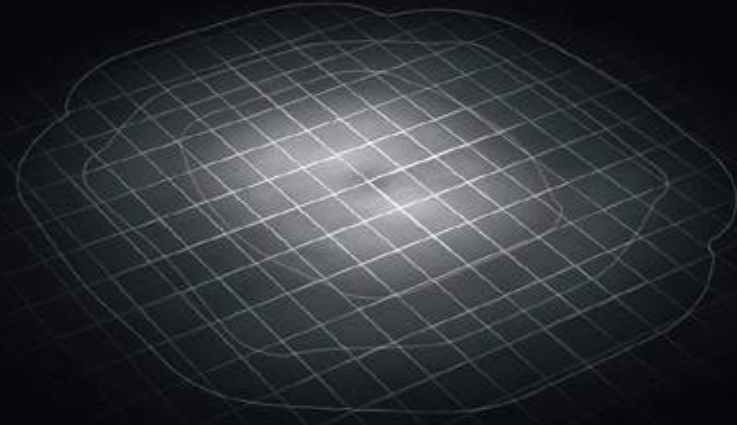

Agathos
Sottoportico / Arcade

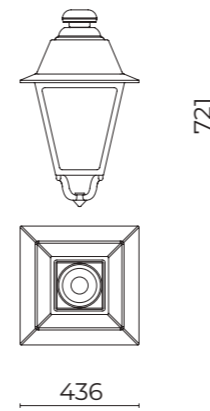

ACCESSORI / ACCESSORIES

01AG903CO
Gancio per sospensione su catena (non compresa)
Suspension hook on chain (not included)

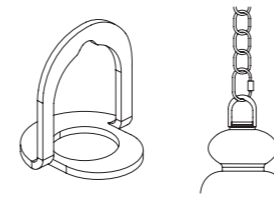

YPSILON

Flessibile all'installazione sia a testa-palo che su braccio, YPSILON è un sistema ideale per l'illuminazione di spazi e percorsi urbani. Design by Silvio De Ponte.

Flexible installation on either a post top or arm makes YPSILON ideal for lighting urban spaces and pathways. Design by Silvio De Ponte.





220 240V	50 60Hz	CL II	IP66	IK08	ta -30°C +50°C
-------------	------------	-------	------	------	----------------------



DATI PRESTAZIONALI / PERFORMANCE DATA

Flusso apparecchio / Fitting flux:
1880 - 13230 lm

Potenza apparecchio / Fitting power:
13,5 - 103,5 W

Indice di resa cromatica / Colour Rendering Index:
CRI ≥ 70, SDCM ≤ 4

Illuminazione intelligente / Smart lighting:
mezzanotte virtuale. Su richiesta ZHAGA, DALI, CLO, PLC,
telegestione wireless / virtual midnight. On request
ZHAGA, DALI, CLO, PLC, wireless telemanagement

MATERIALI / MATERIALS

Corpo e sistemi di fissaggio
Body and fitting system:
pressofusione di lega d'alluminio UNI EN AB 47100
(contenuto rame < 1%) / die-cast aluminum alloy UNI EN
AB 47100 (copper content < 1%)

Copertura / Upper dome:
tornitura di lastra di alluminio
aluminium plate turning

Schermo / Screen:
vetro piano temprato
tempered flat glass

Gruppo ottico / Optical unit:
lenti PMMA ad alta trasparenza
high-transparency PMMA lenses

Finitura / Finish:
fosfocromatazione e verniciatura in polveri di poliestere
realizzata in 16 fasi per la miglior resistenza agli
agenti atmosferici / phospho-chromatation treated
and polyester powder-coated in 16 phases to increase
weather resistance

TEMPERATURA COLORE COLOUR TEMPERATURE

- 3000 K
- 4000 K

COLORI / COLOURS

- SABLÉ 100 NOIR



CARATTERISTICHE / FEATURES

Peso massimo / Max weight:
16 kg

Alimentazione elettronica / Electronic power supply:
inclusa / included

Resistenza sovratensioni / Surge Protection Device:
10 kV CM/DM

Precablaggio / Pre-wiring:
prodotto pre-cablato con cavo e connettore
pre-wired product with cable and connector

Installazione / Installation:
testa palo, lato palo / post top, pole side

OTTICHE / OPTICS

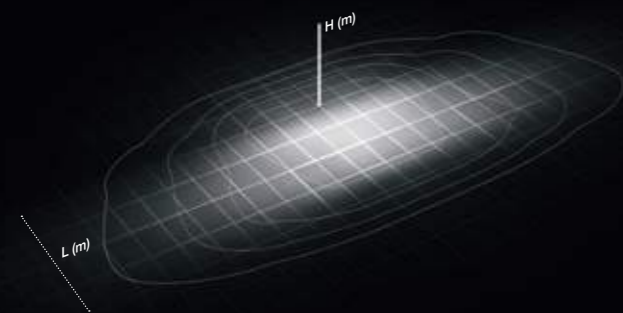
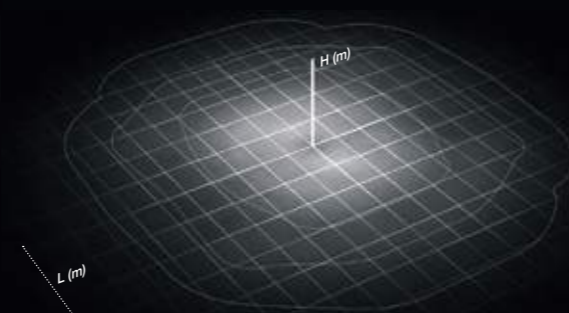
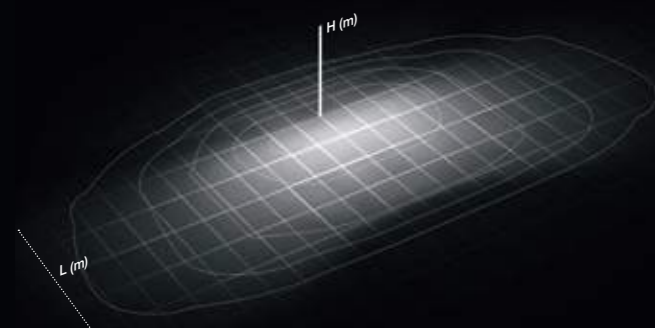
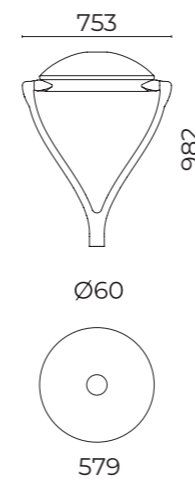
ME-01 Medium Street
L / H = 1RS-01 Rotosymmetric Beam
L / H = 2LA-01 Wide Street
L / H = 1,25Ypsilon
Testa palo / Post top

DATI TECNICI / TECHNICAL DATA

Installazione / Installation:
pali Ø 76 mm con cima Ø 60 mm e innesto
H 90 mm / poles Ø 76 mm with post top Ø 60
and fastening part H 90 mm

ACCESSORI / ACCESSORIES

01AY904C0
L7 - Riduzione per pali
Reduction for poles

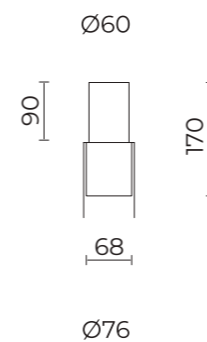

ME-01 Medium Street
L / H = 1

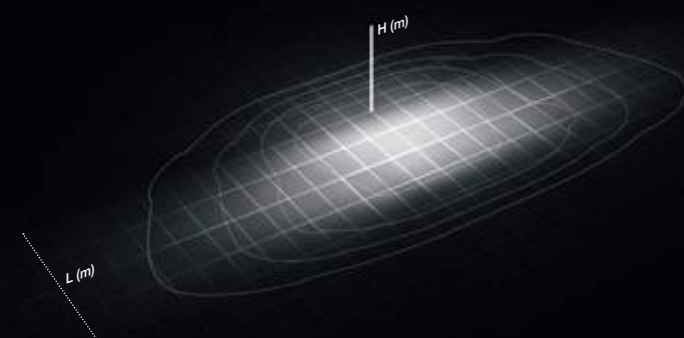

LA-01 Wide Street
L / H = 1,25

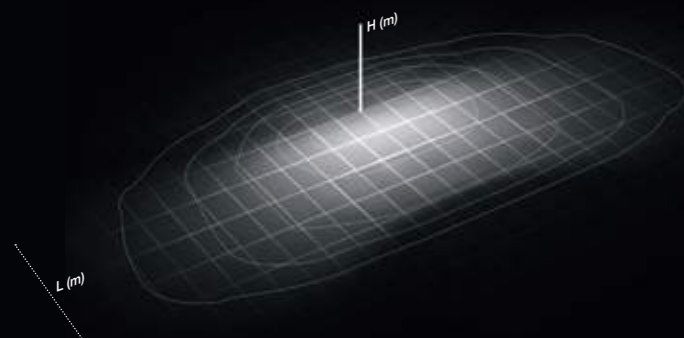

Ypsilon
Lato palo / Pole side

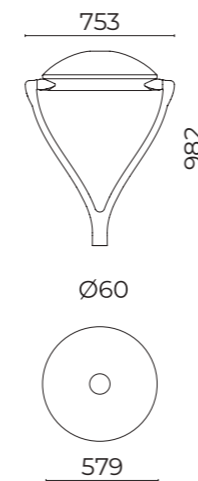

DATI TECNICI / TECHNICAL DATA

Installazione / Installation:
con accessori su pali Ø 102 - 114 mm
with accessories on poles Ø 102 - 114 mm

ACCESSORI / ACCESSORIES

01AY901CO
L6 - Giunto per palo, braccio
inclinato 15° / Coupling for poles,
15° inclined arm

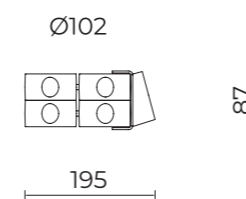

01AY902CO
B25 - Esagono per palo, braccio
inclinato 15° con puntale
Hexagon for poles, 15° inclined arm
with decorative metal point

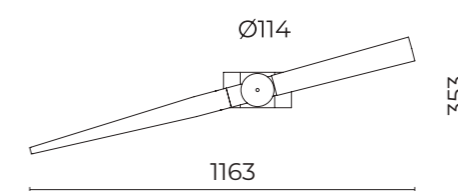

01AY905CO
B27 - Esagono per palo, 2 bracci
inclinati 15° con puntale
Hexagon for poles, 15° inclined double
arms with decorative metal point

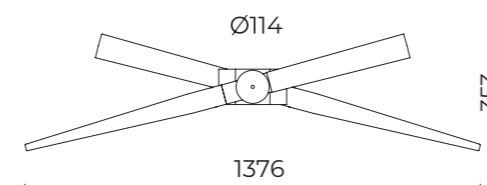

LIT

LIT è un sistema completo e flessibile per l'illuminazione di vuoti e pieni urbani con una forma essenziale, moderna ed elegante.

LIT is a complete flexible system with a clean, modern and elegant shape for lighting empty and full urban locations.





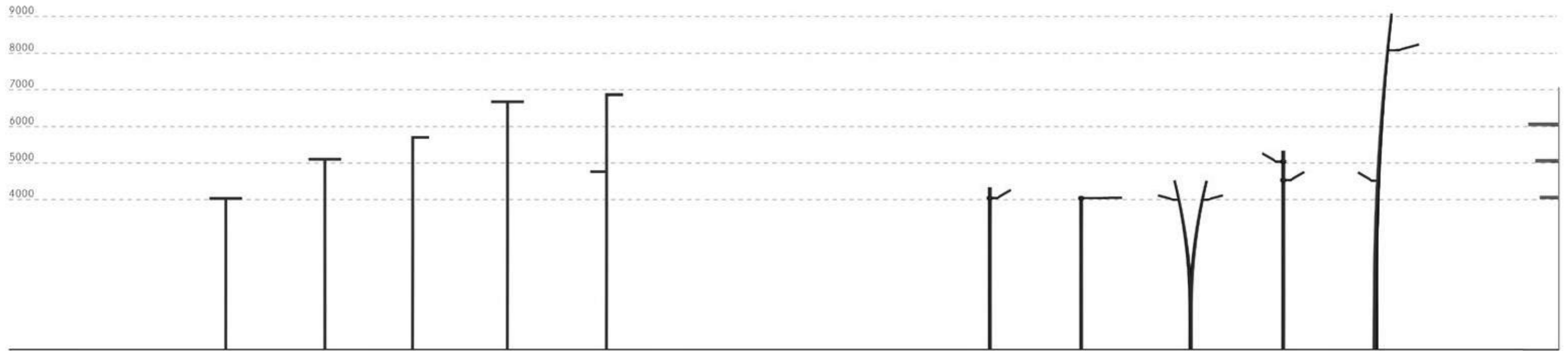

220 240V	50 60Hz	CL II	IP66	IK10	ta -30°C +50°C
-------------	------------	-------	------	------	----------------------



DATI PRESTAZIONALI / PERFORMANCE DATA

Flusso apparecchio / Fitting flux:
2330 - 17055 lm

Potenza apparecchio / Fitting power:
18,5 - 138,5 W

Indice di resa cromatica / Colour Rendering Index:
CRI ≥ 70, SDCM ≤ 3

Illuminazione intelligente / Smart lighting:
mezzanotte virtuale. Su richiesta ZHAGA, DALI, CLO
virtual midnight. On request ZHAGA, DALI, CLO

MATERIALI / MATERIALS

Corpo e sistemi di fissaggio / Body and fastening system:
pressofusione di lega di alluminio UNI EN AB 47100
(contenuto rame < 1%) / die-cast aluminum alloy
UNI EN AB 47100 (copper content < 1%)

Schermo / Screen:
vetro piano temprato
tempered flat glass

Gruppo ottico / Optical unit:
lenti PMMA ad alta trasparenza
high-transparency PMMA lenses

Finitura / Finish:
fosfocromatazione e verniciatura in polveri di poliestere
realizzata in 16 fasi per la miglior resistenza agli agenti
atmosferici / phospho-chromatation treated and polyester
powder-coated in 16 phases to increase weather resistance

TEMPERATURA COLORE COLOUR TEMPERATURE

- 3000 K
- 4000 K

COLORI / COLOURS

- SABLÉ 100 NOIR



CARATTERISTICHE / FEATURES

Peso massimo / Max weight:
4 kg (small), 6 kg (medium), 8 kg (large)

Alimentazione elettronica / Electronic power supply:
inclusa / included

Resistenza sovratensioni / Surge Protection Device:
10 kV MC / MD

Precablaggio / pre-wiring:
prodotto pre-cablato con cavo e connettore
pre-wired product with cable and connector

Installazione / Installation:
parete, soffitto, terra, palo
wall, ceiling, ground, pole

OTTICHE / OPTICS

ME-03 Medium Street
L / H = 1,1LT-62 Asymmetric Beam
L / H = 2LA-02 Wide Street
L / H = 1,25Lit
Flood 1

DATI TECNICI / TECHNICAL DATA

Installazione / Installation:
parete, soffitto, terra
wall-mounted, ceiling, ground

Orientabilità / Orientability:
con giunto inclinazione $+35^\circ + -90^\circ$, rotazione $\pm 30^\circ$
with joint tilt $+35^\circ + -90^\circ$, rotation $\pm 30^\circ$

SMALL

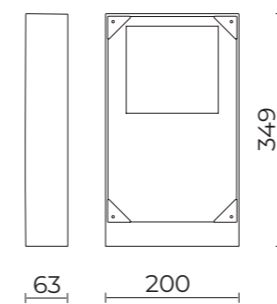

MEDIUM

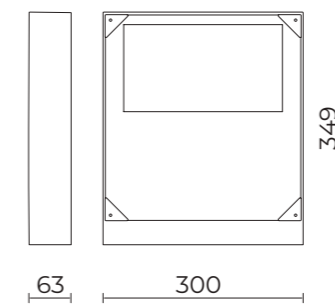

LARGE

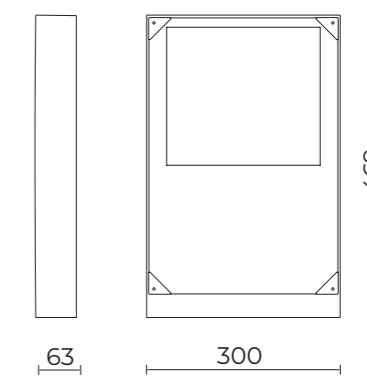

Lit

Lit

Flood 1

ACCESSORI / ACCESSORIES

LIT SMALL

06LT901CO

B110 - Giunto orientabile

Adjustable joint

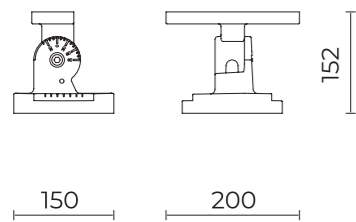

06LT903CO

B112 - Giunto orientabile per braccio e picchetto

Adjustable joint for bracket and spike

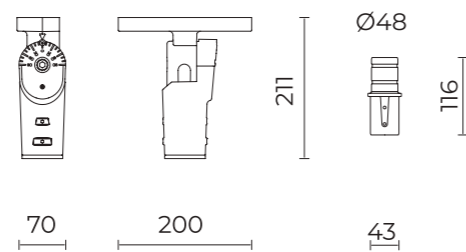

LIT MEDIUM - LARGE

06LT902CO

B111 - Giunto orientabile

Adjustable joint

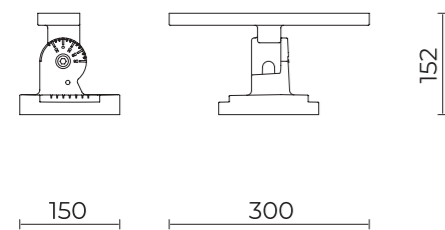

06LT904CO

B114 - Giunto orientabile per braccio e picchetto

Adjustable joint for bracket and spike

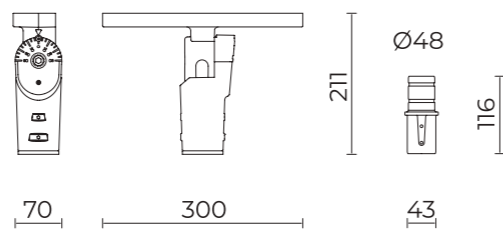

06LT909JO

B118 - Ancore per calcestruzzo

Anchor for concrete

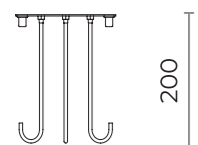

06LT908CO

B117 - Picchetto per interrimento

Spike for ground installation

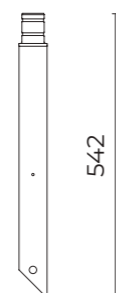

OTTICHE / OPTICS

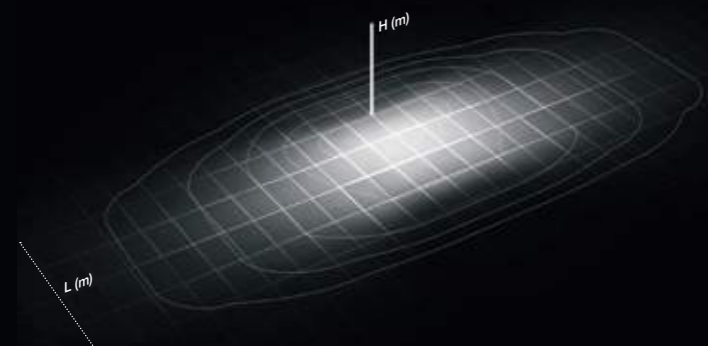
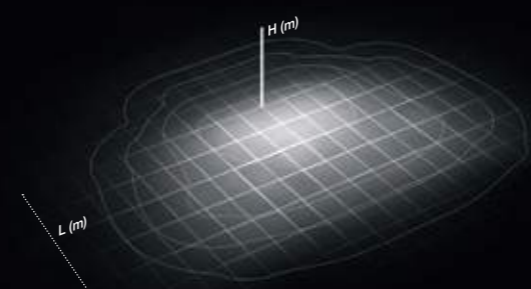
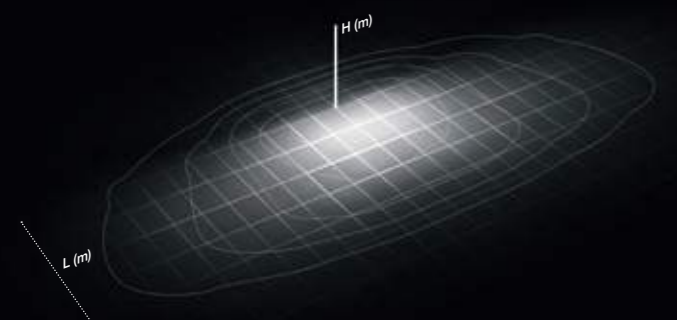
ME-03 Medium Street
L / H = 1,1LT-62 Asymmetric Beam
L / H = 2LA-02 Wide Street
L / H = 1,25Lit
System

DATI TECNICI / TECHNICAL DATA

Installazione / Installation:
palo rettangolare H 4 m, 6 m
rectangular pole H 4 m, 6 m

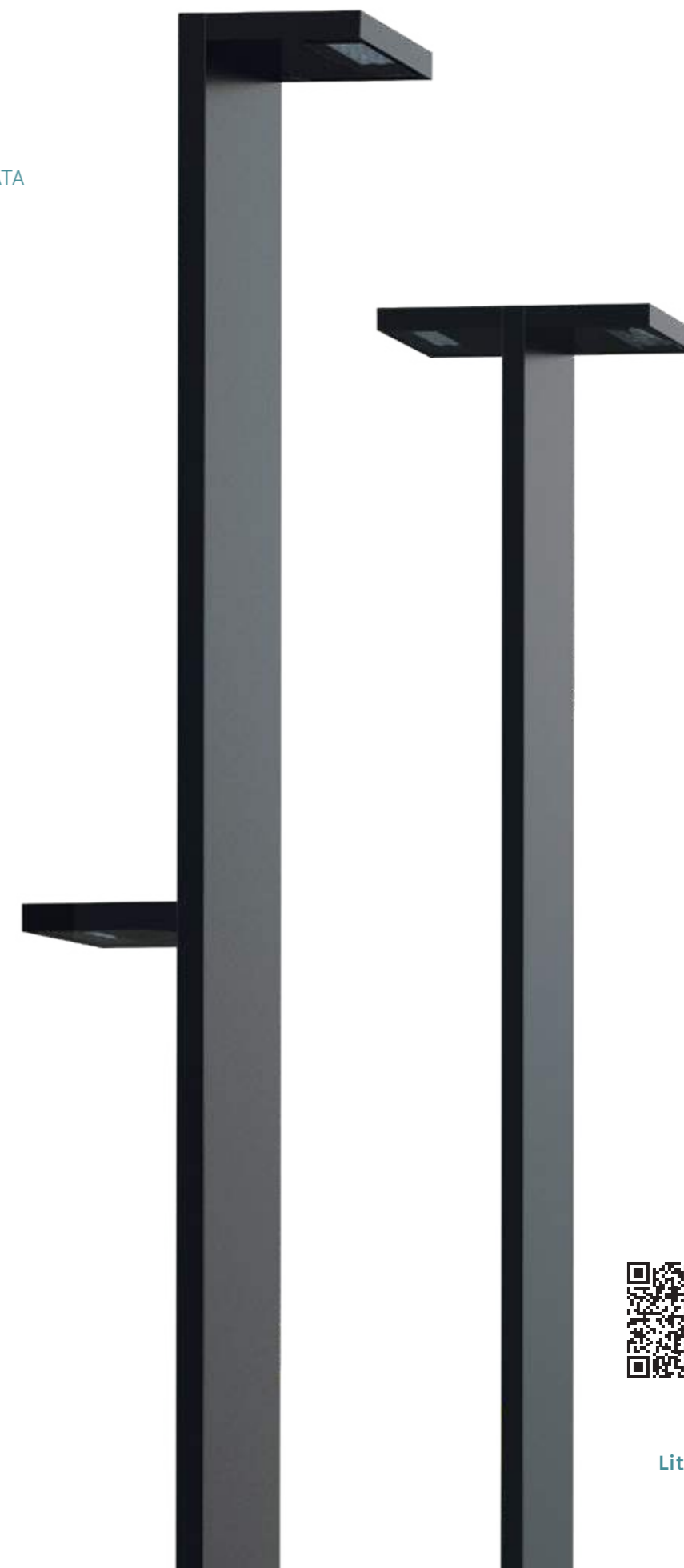

Lit
System

PALI / POLES

LIT SMALL

06LT914CO
B123 - Palo in alluminio estruso H 4 m (Lit small)
 Aluminium extruded pole H 4 m (Lit small)

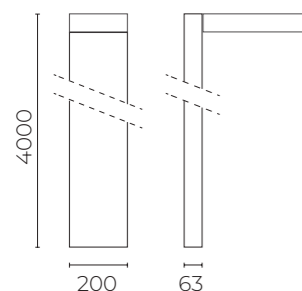

06LT926CO
B160 - Palo in alluminio estruso H 4 m (2 Lit small)
 Aluminium extruded pole H 4 m (2 Lit small)

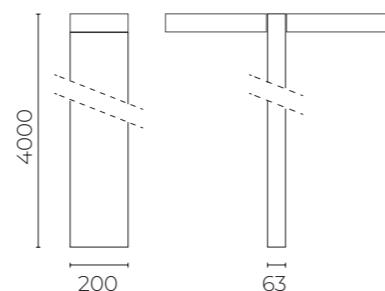

LIT MEDIUM - LARGE

06LT915CO
B124 - Palo in alluminio estruso H 6 m (Lit medium/large)
 Aluminium extruded pole H 6 m (Lit medium/large)

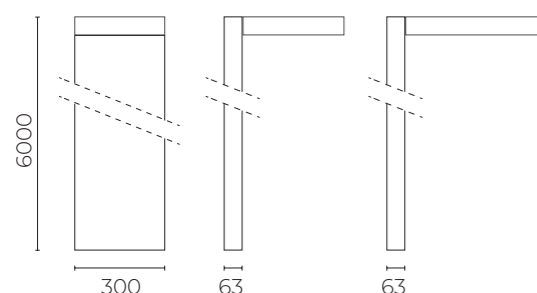

06LT927CO
B161 - Palo in alluminio estruso H 6 m (2 Lit medium/large)
 Aluminium extruded pole H 6 m (2 Lit medium/large)

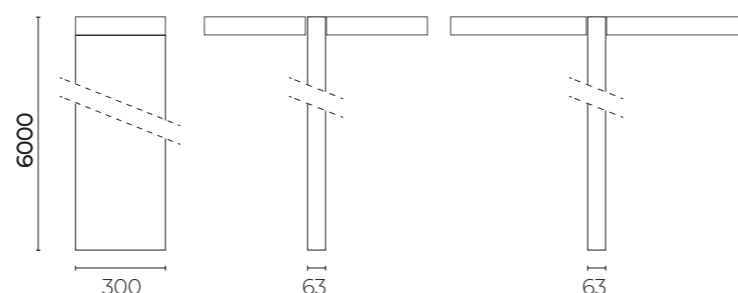

06LT928CO
B162 - Palo in alluminio estruso H 6 m per 2 Lit medium / large (H 4 m e H 6 m)
 Aluminium extruded pole H 6 m for 2 Lit medium / large (H 4 m and H 6 m)

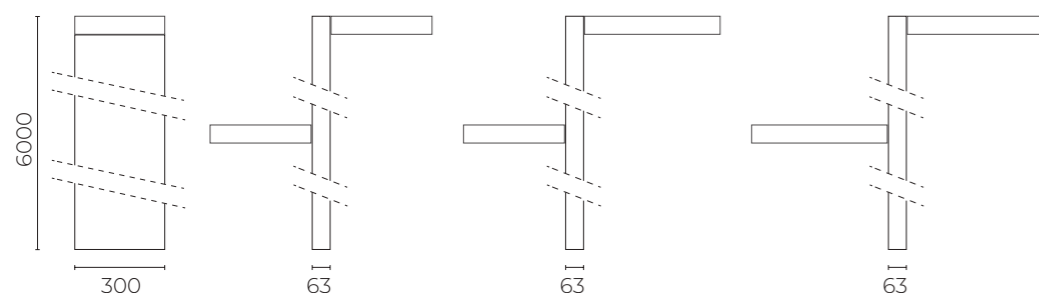

OTTICHE / OPTICS

ME-03 Medium Street
L / H = 1,1

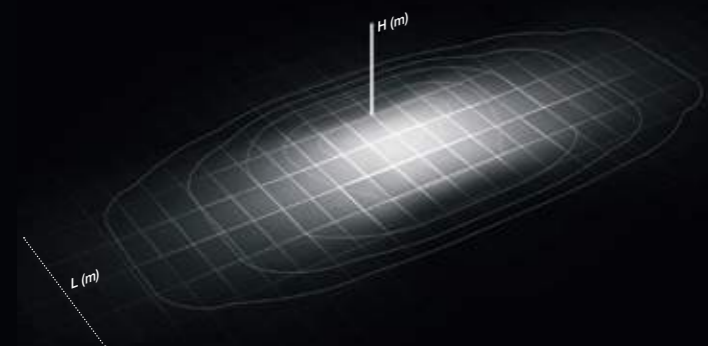

LT-62 Asymmetric Beam
L / H = 2

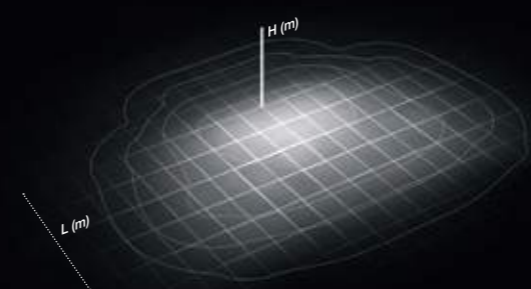

LA-02 Wide Street
L / H = 1,25

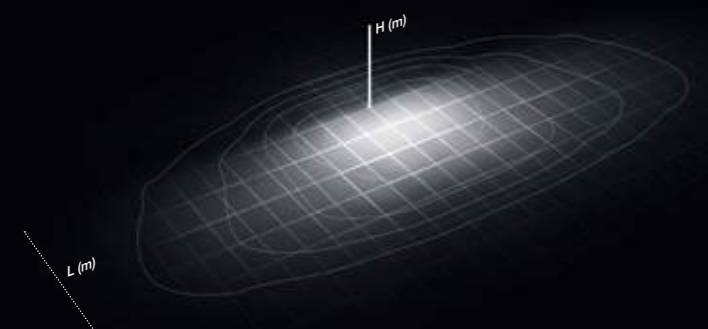

Lit
Poles

DATI TECNICI / TECHNICAL DATA

Installazione / Installation:
con collare su pali Ø 60 - 76 - 102 mm
with collar on poles Ø 60 - 76 - 102 mm



Lit

Poles

ACCESSORI / ACCESSORIES

LIT SMALL

06LT929C0
B166 - Collare singolo per pali
Ø 60 mm / Single collar for
poles Ø 60 mm

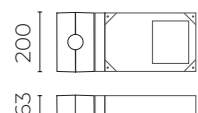

06LT930C0
B167 - Collare doppio per pali
Ø 60 mm / Double collar for
poles Ø 60 mm

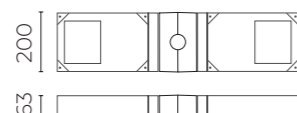

06LT910C0
B119 - Collare singolo
per pali Ø 76 mm / Single
collar for poles Ø 76 mm

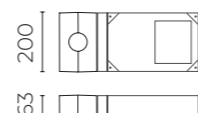

06LT937C0
B174 - Collare singolo per pali
Ø 76 mm / Single collar for
poles Ø 76 mm

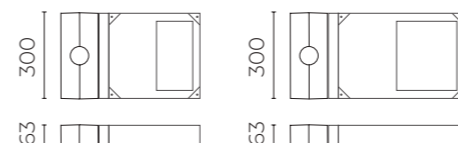

06LT938C0
B175 - Collare doppio per pali Ø 76 mm
Double collar for poles Ø 76 mm

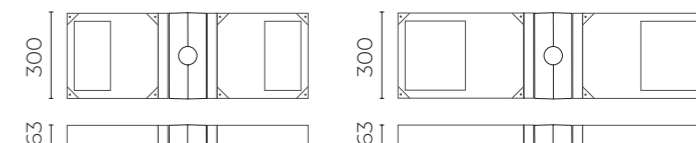

06LT911C
B120 - Collare doppio per pali
Ø 76 mm / Double collar for
poles Ø 76 mm

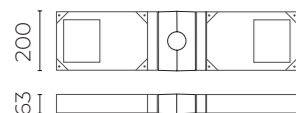

06LT933C0
B170 - Collare singolo per pali
Ø 102 mm / Single collar for
poles Ø102 mm

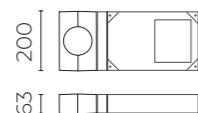

06LT934C0
B171 - Collare doppio per
pali Ø 102 mm / Double
collar for poles Ø102 mm

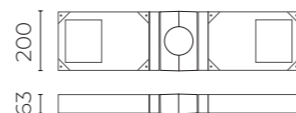

06LT912C0
B121 - Collare singolo per pali
Ø 102 mm / Single collar for
poles Ø 102 mm

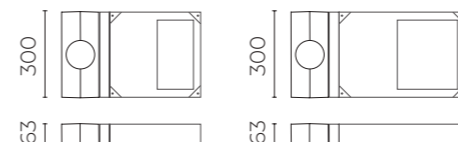

06LT913C0
B122 - Collare doppio per pali Ø 102 mm
Double collar for poles Ø 102 mm

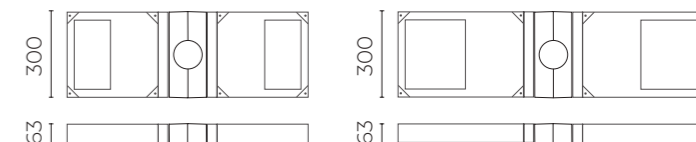

LIT MEDIUM - LARGE

06LT935C0
B172 - Collare singolo per pali Ø 60 mm
Single collar for poles Ø 60 mm

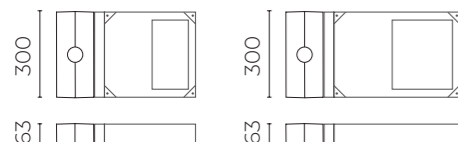

06LT936C0
B173 - Collare doppio per pali Ø 60 mm
Double collar for poles Ø 60 mm

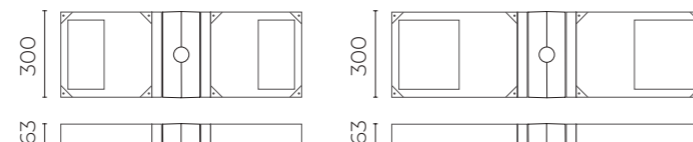



MILAN
Italy



GENOVA
Italy

ATHENS
Greece

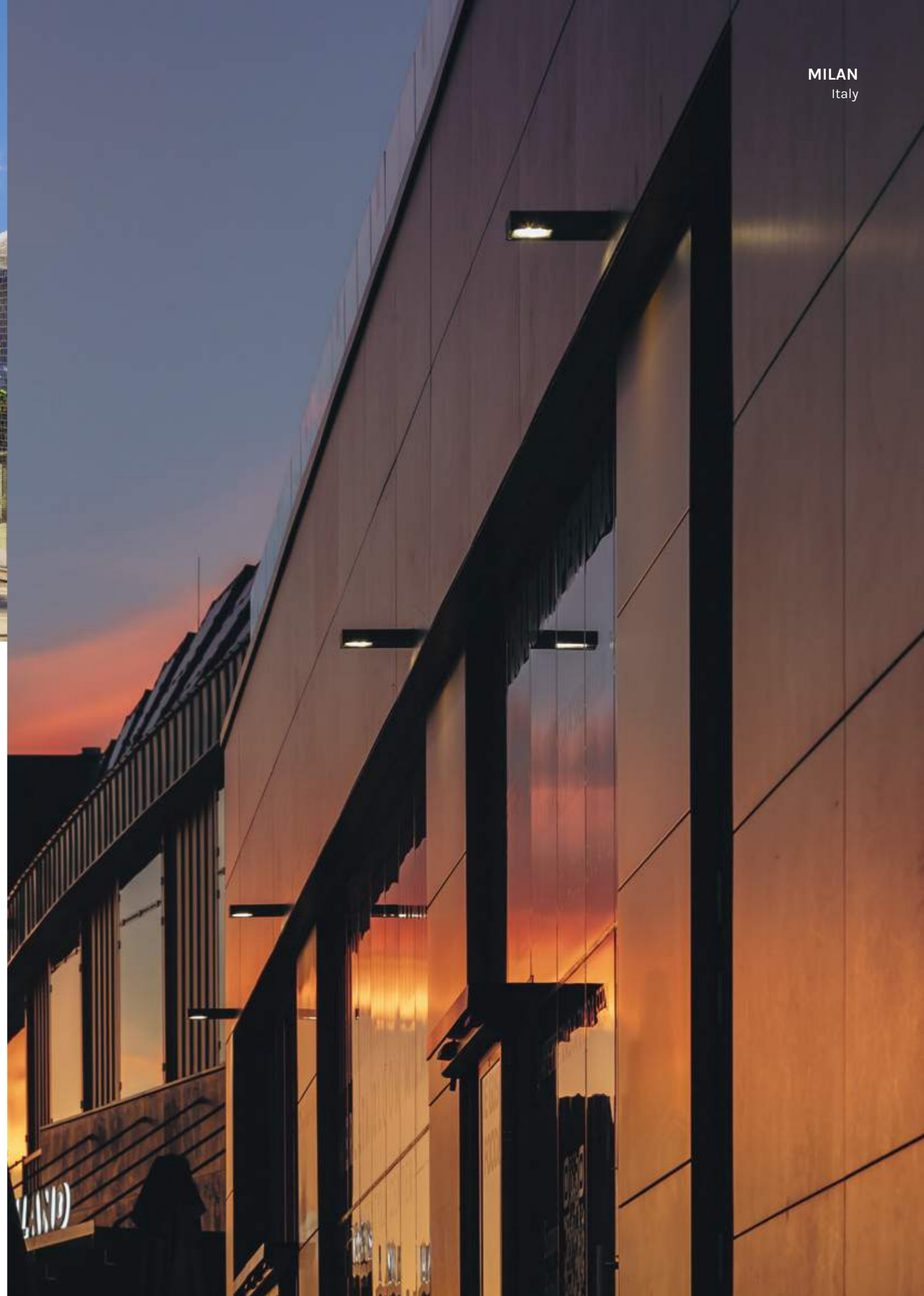

OTTICHE / OPTICS

ME-03 Medium Street
L / H = 1,1

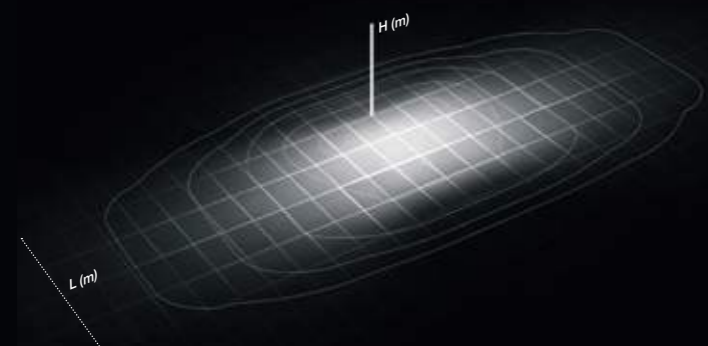

LT-62 Asymmetric Beam
L / H = 2

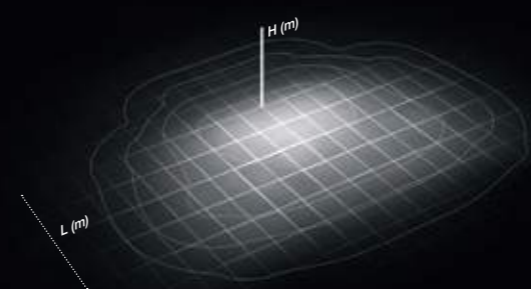

LA-02 Wide Street
L / H = 1,25

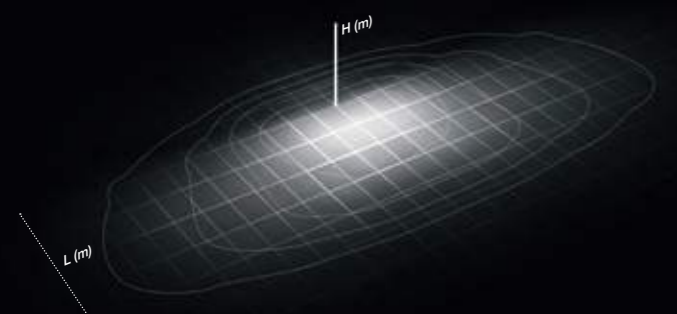

Lit

Brackets and poles

DATI TECNICI / TECHNICAL DATA

Installazione / Installation:
con accessori su pali Ø 60 - 76 - 102 mm
with accessories on poles Ø 60 - 76 - 102 mm

Inclinazione / Inclination:
-90°



Lit

Brackets and poles

ACCESSORI E BRACCI / ACCESSORIES AND ARMS:

06LT903CO**B112 - Giunto orientabile per braccio**

Ø 60 mm Lit small

Adjustable joint for bracket Ø 60 mm Lit small

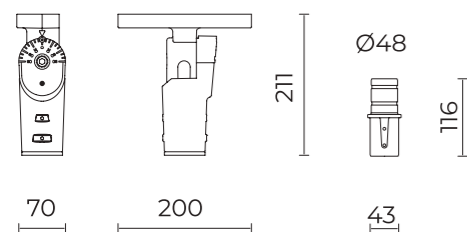
**06LT904CO****B114 - Giunto orientabile per braccio**

Ø 60 mm Lit medium, large / Adjustable joint

for bracket Ø 60 mm Lit medium, large

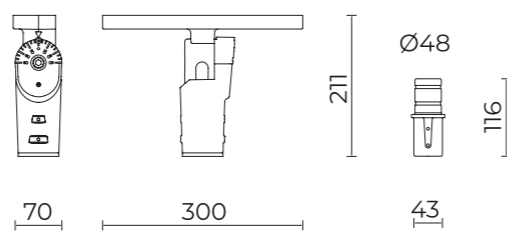
**01AK921CO****B1 - Braccio per pali**

Arm for poles

Ø60-76

**01AK922CO****B2 - Braccio doppio per pali**

Double arm for poles

Ø60-76

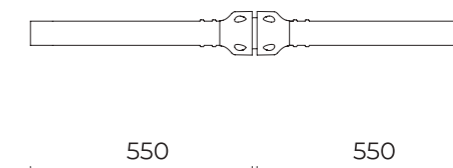
**01AK903CO****L3 - Kit giunto per palo o braccio**

Joint kit for pole or arm

Ø60-76

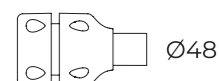
**01AK904CO****L4 - Kit giunto doppio per palo o braccio**

Double joint kit for pole or arm

Ø60-76

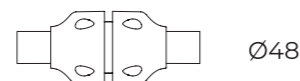
**06AK907CO****B155 - Braccio per pali**

Arm for poles

Ø102

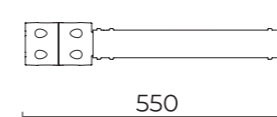
**06AK909CO****B157 - Braccio doppio per pali**

Double arm for poles

Ø102

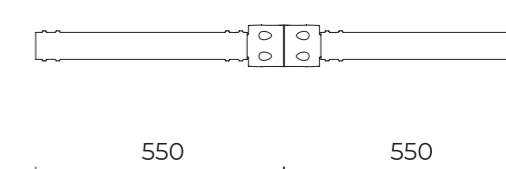
**06AK916CO****B139 - Anello per pali**

Ring for poles

Ø102

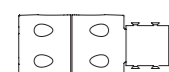
**06AK917CO****B140 - Anello doppio per pali**

Double ring for poles

Ø102

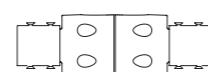

SIGMA STREET



L'elevato contenuto tecnologico si cela
all'interno di volumi tondeggianti che ricordano
le linee dello streamlining.

High technological content is hidden inside
rounded enclosures that recall the
streamlined lines.



SPORTS CENTER

SUPERMARKET

leisure supermarket

built shop

shop



220 240V	50 60Hz	CL II	IP66	IK09	IK10 (POST TOP)	ta -30°C +50°C
-------------	------------	-------	------	------	--------------------	----------------------



DATI PRESTAZIONALI / PERFORMANCE DATA

Flusso apparecchio / Fitting flux:
1230 - 23180 lm

Potenza apparecchio / Fitting power:
12 - 155 W

Indice di resa cromatica / Colour Rendering Index:
CRI ≥ 70, SDCM ≤ 3

Illuminazione intelligente / Smart lighting:
mezzanotte virtuale. DALI, CLO su richiesta
virtual midnight. DALI, CLO on request

MATERIALI / MATERIALS

Corpo e sistemi di fissaggio / Body and fitting system:
pressofusione di lega d'alluminio UNI EN AB 47100
(contenuto rame < 1%) / die-cast aluminium alloy UNI EN
AB 47100 (copper content < 1%)

Schermo / Screen:
vetro piano temprato / tempered flat glass

Gruppo ottico / Optical unit:
lenti PMMA ad alta trasparenza
high-transparency PMMA lenses

Finitura / Finish:
fosfocromatazione e verniciatura in polveri di poliestere
realizzata in 16 fasi per la miglior resistenza agli
agenti atmosferici / phospho-chromatation treated
and polyester powder-coated in 16 phases to increase
weather resistance

TEMPERATURA COLORE COLOUR TEMPERATURE

- 2700 K
- 3000 K
- 4000 K

COLORI / COLOURS

- SABLÉ 100 NOIR

CARATTERISTICHE / FEATURES

Peso massimo / Max weight:
4 kg (small), 8 kg (medium)

Alimentazione elettronica / Electronic power supply:
inclusa / included

Resistenza sovratensioni / Surge Protection Device:
10 kV MC/MD

Precablaggio / Pre-wiring:
prodotto precablato con cavo e connettore
pre-wired product with cable and connector

Installazione / Installation:
testa palo, lato palo / post top, pole side

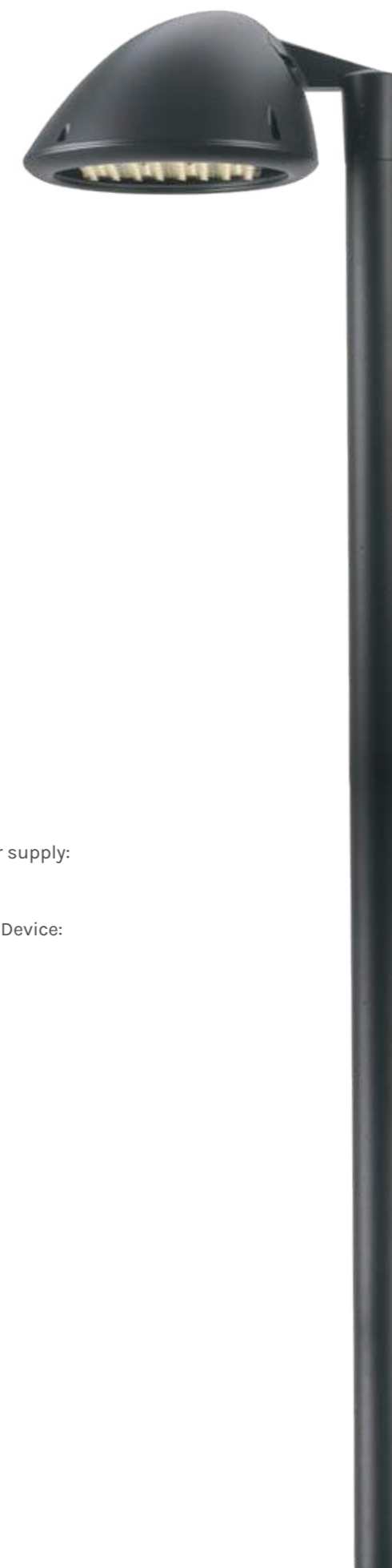

OTTICHE / OPTICS

LT-C1 Cycle Path
L / H = 0,5

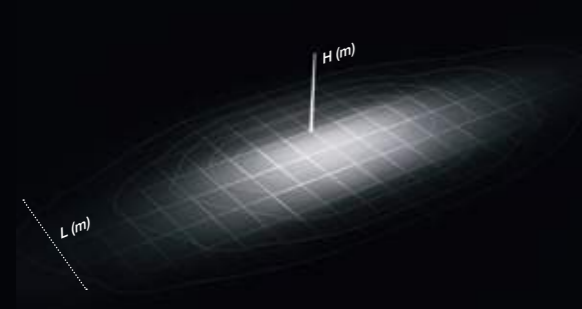

LA-03 Wide Street
L / H = 1,25

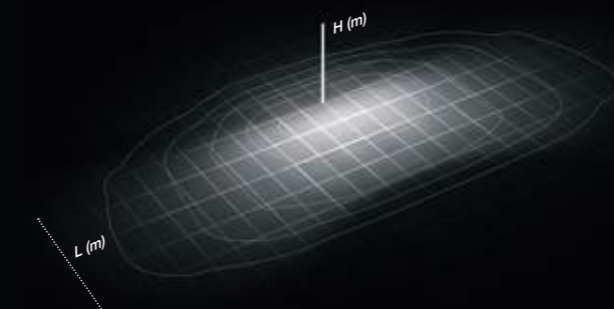

ST-02 Narrow Street
L / H = 0,75

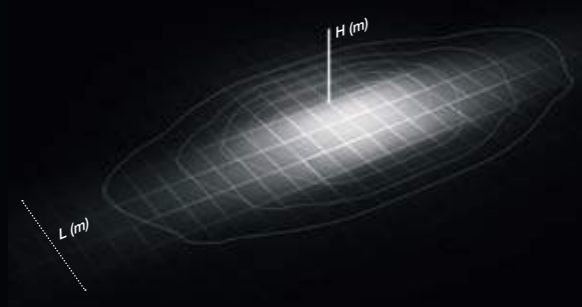

PB-01 Low Pole
L / H = 2

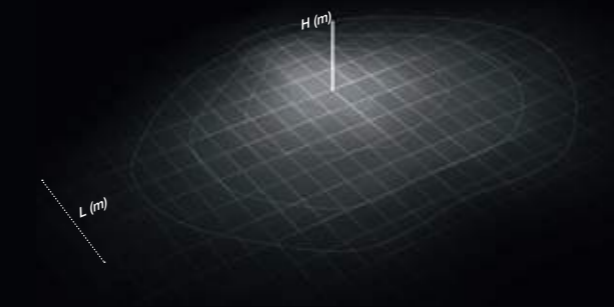

ME-05 Medium Street
L / H = 1

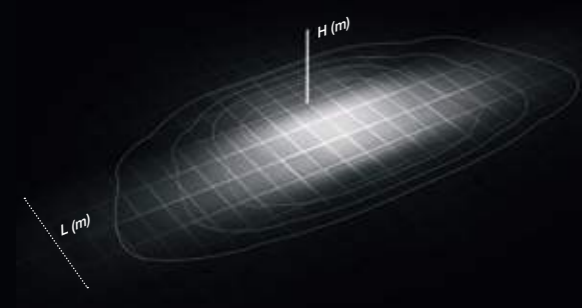

LT-64 Asymmetric Beam with backlight
L / H = 2

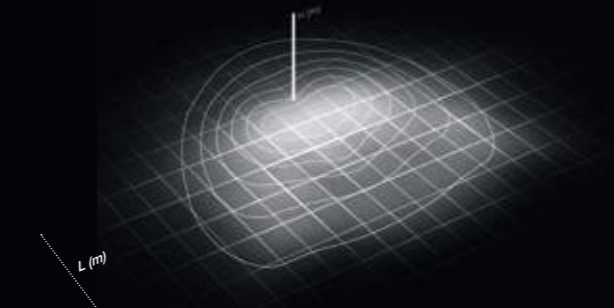

SMALL

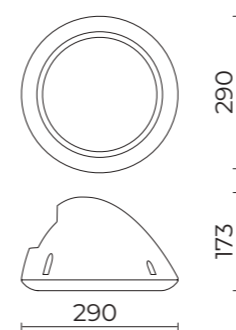

MEDIUM

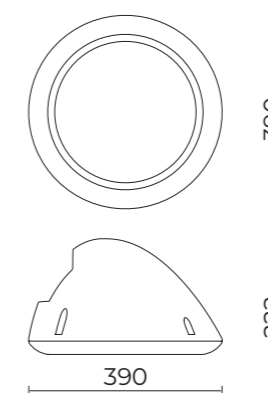

DATI TECNICI / TECHNICAL DATA

Installazione / Installation:

testa palo con accessorio 06SG905C0, su bracci Ø 60 mm con appositi accessori per pali Ø 60 - 76 - 102 mm / post top with accessory 06SG905C0, on arms Ø 60 mm with dedicated accessories for poles Ø 60 - 76 - 102 mm

Inclinazione / inclination:

lato palo, parete, terra -90° +35°
pole side, wall, ground -90° +35°

ACCESSORI / ACCESSORIES

06SG905C0

B178 - Kit testa palo innesto H 90 mm (Sigma small e medium)

Kit post top with fastening part H 90 mm (Sigma small and medium)

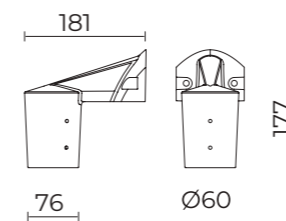

Sigma Street

ACCESSORI E BRACCI / ACCESSORIES AND ARMS

06SG906C0
B179 - Kit lato palo small regolabile
 Adjustable kit pole side small

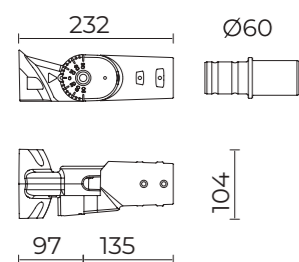

06SG907C0
B180 - Kit lato palo medium regolabile
 Adjustable kit pole side medium

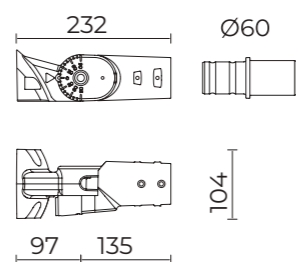

01AK903C0
L3 - Kit giunto per pali
 Joint kit for poles

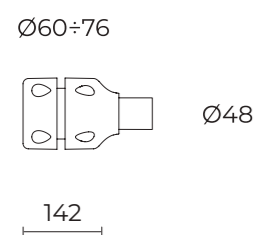

01AK904C0
L4 - Kit giunto doppio per pali
 Double joint kit for poles

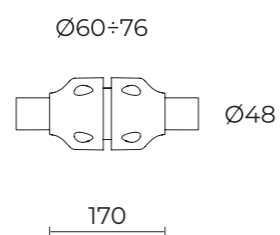

01AK921C0
B1 - Braccio per pali
 Arm for poles

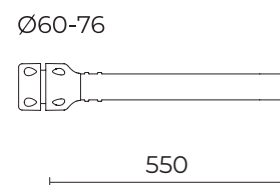

01AK922C0
B2 - Braccio doppio per pali
 Double arm for poles

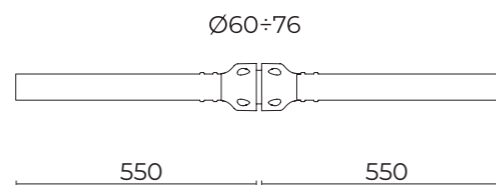

06AK916C0
B139 - Anello per pali
 Ring for poles

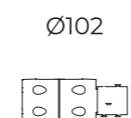

06AK917C0
B140 - Anello doppio per pali
 Double ring for poles

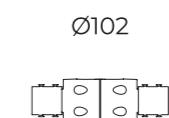

06AK907C0
B155 - Braccio per pali
 Arm for poles

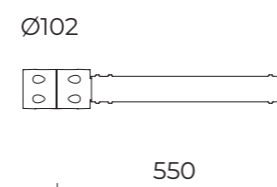

06AK909C0
B157 - Braccio doppio per pali
 Double arm for poles

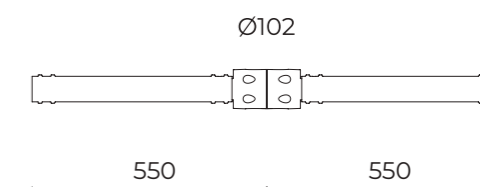

06SG908C0
B181 - Giunto regolabile parete o terra small / Adjustable joint for wall or ground small

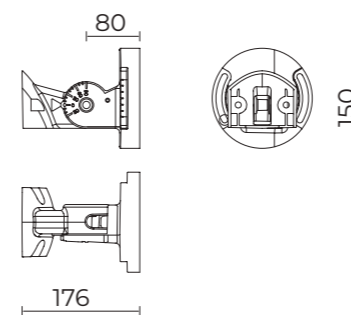

06SG909C0
B182 - Giunto regolabile parete o terra medium / Adjustable joint for wall or ground medium

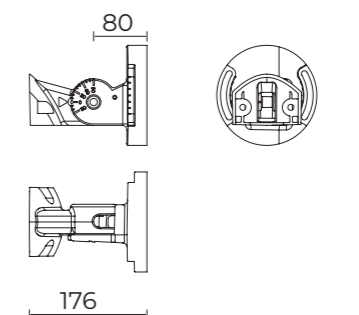

06KS909C0
B89 - Connettore 4 vie IP68
 Connector 4 way IP68

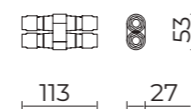

VOLTA



L'ampia gamma di soluzioni ottiche e di fissaggi rende VOLTA ideale per l'illuminazione di spazi e percorsi urbani in ogni città.

The wide range of optical and fastening solutions makes VOLTA ideal for lighting urban spaces and pathways in any city.

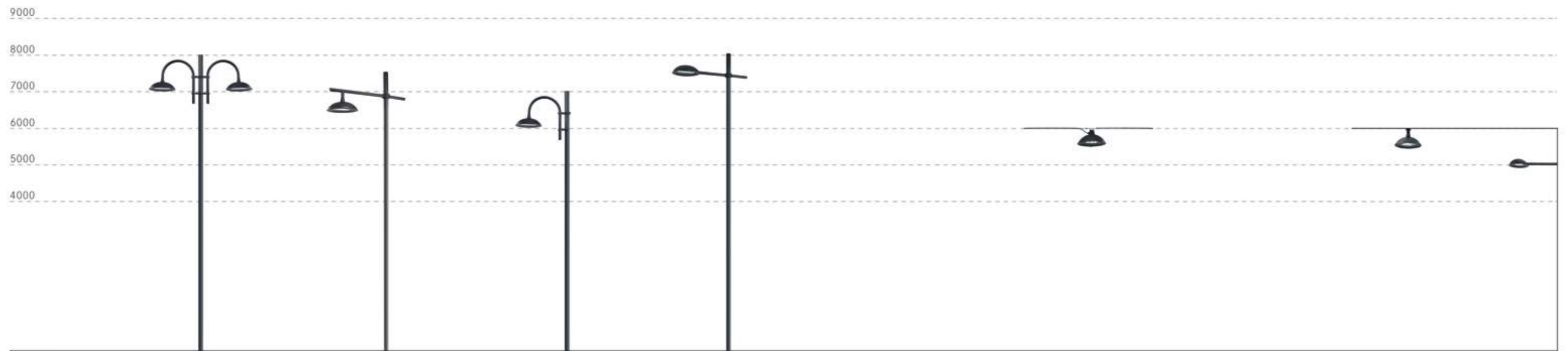



220 240V	50 60Hz	CL II	IP66	IK09	ta -30°C +50°C
-------------	------------	-------	------	------	----------------------



DATI PRESTAZIONALI / PERFORMANCE DATA

Flusso apparecchio / Fitting flux:
1355 (1800 K) - 23180 lm

Potenza apparecchio / Fitting power:
12 - 155 W

Indice di resa cromatica / Colour Rendering Index:
CRI ≥ 70, SDCM ≤ 3

Illuminazione intelligente / Smart Lighting:
mezzanotte virtuale. Su richiesta ZHAGA, DALI, CLO, PLC,
telegestione wireless
virtual midnight. On request ZHAGA, DALI, CLO, PLC,
wireless telemanagement

MATERIALI / MATERIALS

Corpo e sistemi di fissaggio / Body and fitting system:
pressofusione di lega d'alluminio UNI EN AB 47100
(contenuto rame < 1%) / die-cast aluminum alloy UNI EN
AB 47100 (copper content < 1%)

Schermo / Screen:
vetro piano temprato / tempered flat glass

Gruppo ottico / Optical unit:
lenti PMMA ad alta trasparenza
PMMA high transparent lenses

Finitura / Finish:
fosfocromatazione e verniciatura in polveri di poliestere
realizzata in 16 fasi per la miglior resistenza agli
agenti atmosferici / phospho-chromatation treated
and polyester powder-coated in 16 phases to increase
weather resistance

TEMPERATURA COLORE COLOUR TEMPERATURE

- 2200 K
- 2700 K
- 3000 K
- 4000 K

ECO-CENTRIC LIGHTING (ECL)

(ONLY FOR STREET OPTICS)

BLUE FREE LIGHT:
PC-AMBER 0,7% $\sum R$ (λ < 500NM) – CRI 40
1800 K 4,3% $\sum R$ (λ < 500NM) – CRI 70

SWITCHABLE WHITE LIGHT:
1800K / 3000K

COLORI / COLOURS

- SABLÉ 100 NOIR



CARATTERISTICHE / FEATURES

Peso massimo / Max weight:
8,2 kg (small), 12 kg (medium)

Alimentazione elettronica / Electronic power supply:
inclusa / included

Resistenza sovratensioni / Surge Protection Device:
10 kV MC/MD

Apertura vano cablaggio / Wiring compartment opening:
mediante clip / by clip

Installazione / Installation:
lato palo, sospensione braccio, sospensione tesata, parete,
sottoportico / pole side, arm suspension, string suspension,
wall, arcade

OTTICHE / OPTICS

LT-C1 Cycle Path
L / H = 0,5

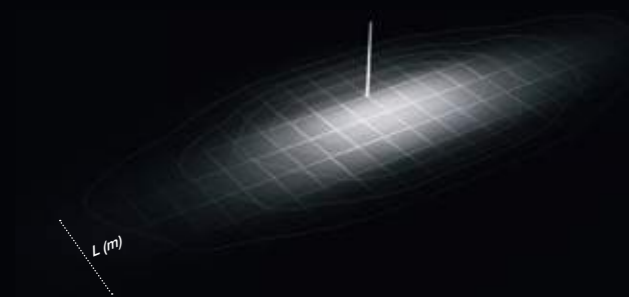

PB-01 Low Pole
L / H = 2

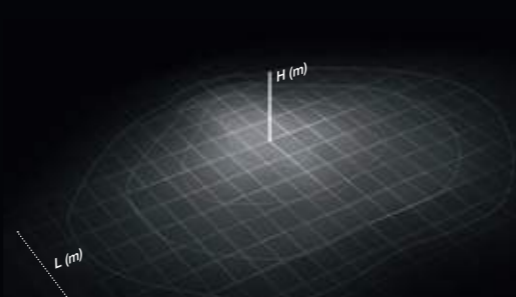

ST-02 Narrow Street
L / H = 0,75

ECL

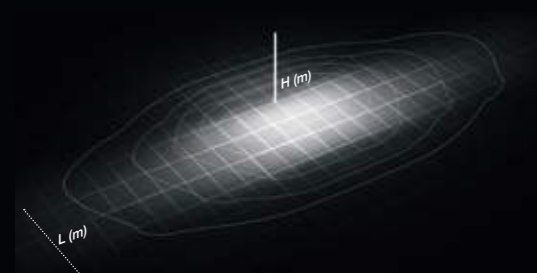

LT-64 Asymmetric Beam with backlight
L / H = 2

ECL



ME-05 Medium Street
L / H = 1

ECL

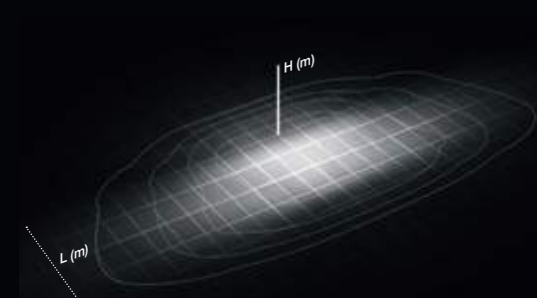

AP-D2 Pedestrian Crossing

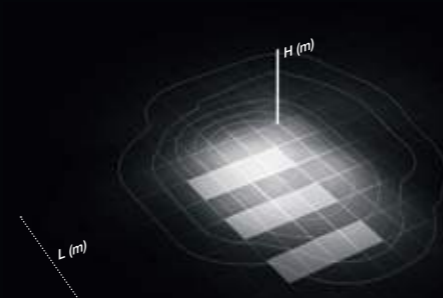

LA-03 Wide Street
L / H = 1,25

ECL

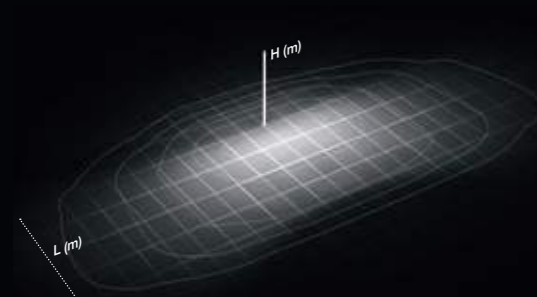

AP-S2 Pedestrian Crossing

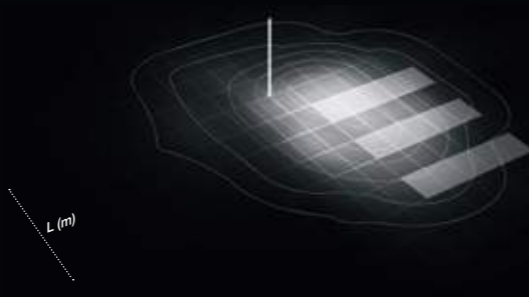

SMALL

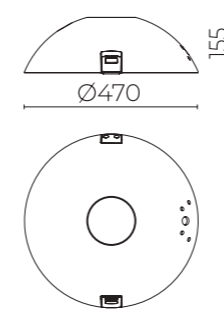

MEDIUM

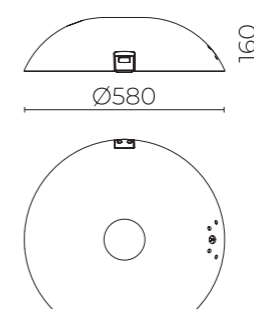

DATI TECNICI / TECHNICAL DATA

Installazione / Installation:
con accessori, su pali Ø 60 - 76 - 102 mm
with accessories, on poles Ø 60 - 76 - 102 mm



Volta

Lato palo / Pole side

ACCESSORI E BRACCI / ACCESSORIES AND ARMS

01V0901C0
L17 - Kit laterale fisso per braccio
 Fixed side kit for arm

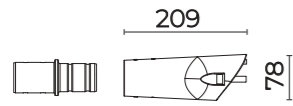

01V0902C0
L16 - Kit laterale regolabile per palo o braccio
 Adjustable side kit for pole or arm

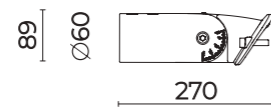

01AK984C0
B208 - Braccio per pali
 Arm for poles

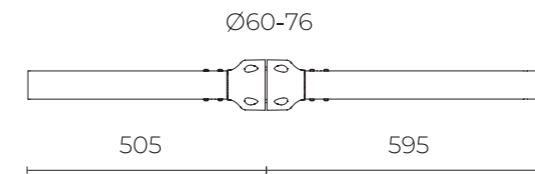

01AK985C0
B209 - Braccio doppio per pali
 Double arm for poles

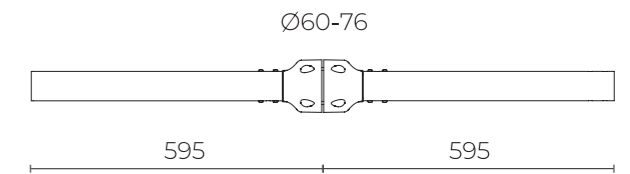

01V0904C0
B204 - Kit giunto per palo
 Joint kit for pole

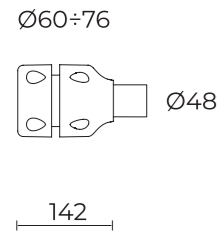

01V0905C0
B205 - Kit giunto doppio per palo
 Double joint kit for pole

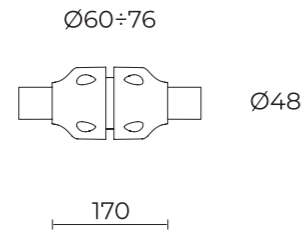

01AK986C0
B210 - Braccio per pali
 Arm for poles

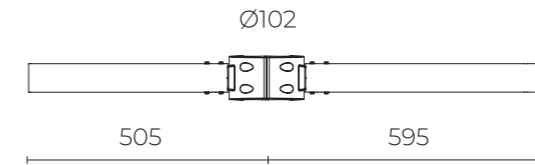

01AK987C0
B211 - Braccio doppio per pali
 Double arm for poles

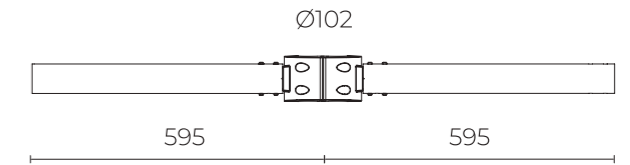

06AK905C0
B153 - Giunto testa palo H 90 mm
 Joint post top H 90 mm

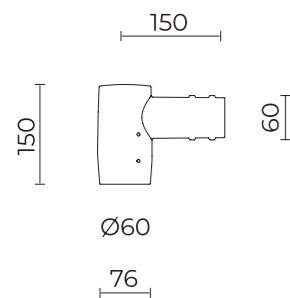

06AK906C0
B154 - Braccio per palo
 Arm for pole

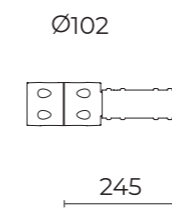

06AK908C0
B156 - Braccio doppio per palo
 Double arm for pole

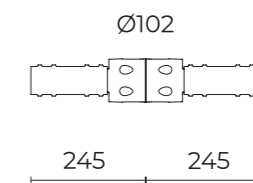

OTTICHE / OPTICS

LT-C1 Cycle Path
L / H = 0,5

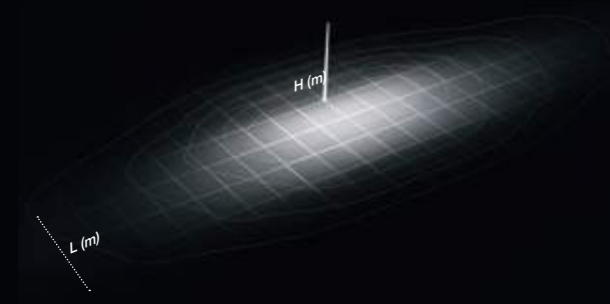

LA-03 Wide Street
L / H = 1,25

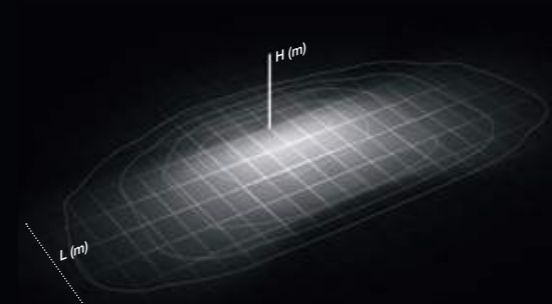

ECL

ST-02 Narrow Street
L / H = 0,75

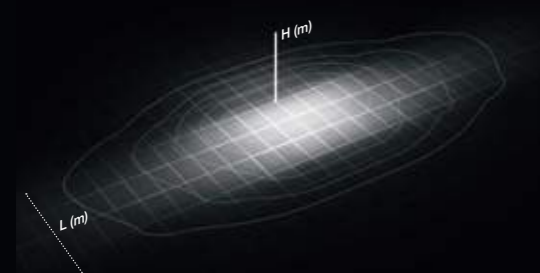

ECL

PB-01 Low Pole
L / H = 2

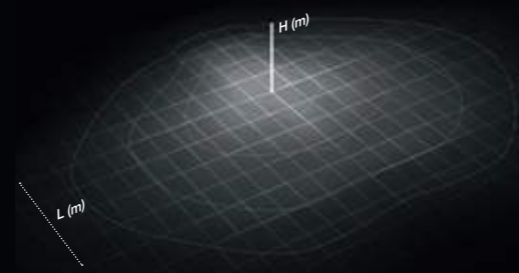

ME-05 Medium Street
L / H = 1

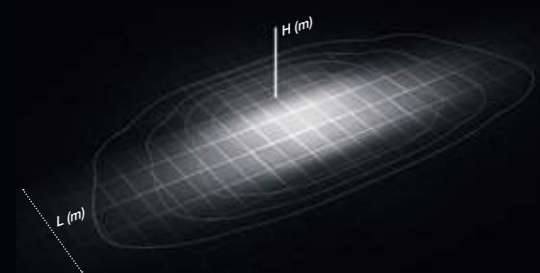

ECL

LT-64 Asymmetric Beam with backlight
L / H = 2

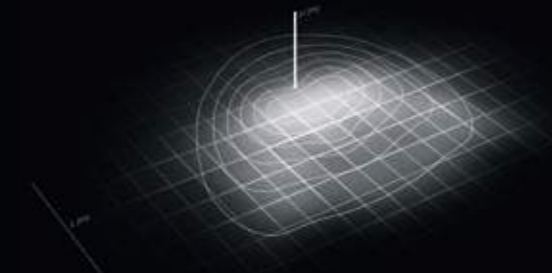

ECL



SMALL

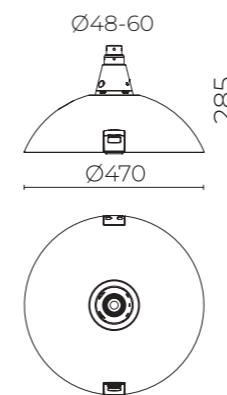

MEDIUM

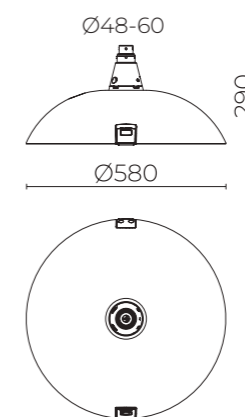

DATI TECNICI / TECHNICAL DATA

Installazione / Installation:
con accessori, su pali Ø 60 - 76 - 102 mm
with accessories, on poles Ø 60 - 76 - 102 mm



Volta

Sospensione braccio / Arm suspension

ACCESSORI E BRACCI / ACCESSORIES AND ARMS

01AK907C0
L16 - Kit sospensione maschio 1" 1/2 GAS
 Male suspension kit 1" 1/2 GAS

1" 1/2 GAS



Ø48

01AK914C0
L17 - Kit sospensione maschio 3/4" GAS
 Male suspension kit 3/4" GAS

3/4" GAS

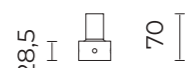

Ø48

01AK992C0
B216 - Braccio per pali
 Arm for poles

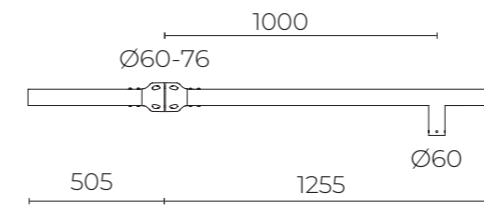

01AK994C0 Ø60
B217 - Braccio doppio per pali
 Double arm for poles

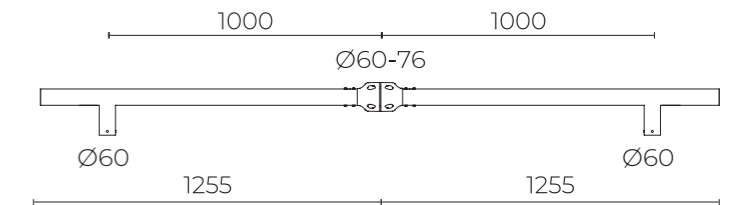

01AK988C0
B212 - Braccio per pali
 Arm for poles

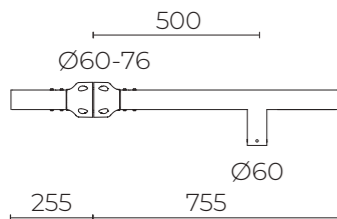

01AK989C0
B213 - Braccio doppio per pali
 Double arm for poles

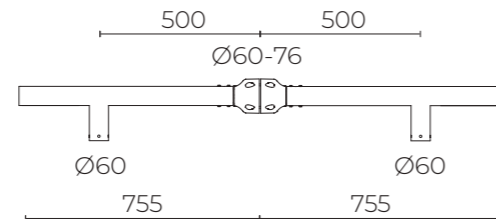

01AK995C0
B218 - Braccio per pali
 Arm for poles

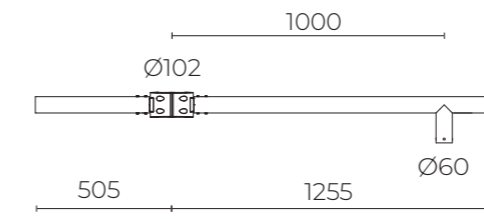

01AK996C0
B219 - Braccio doppio per pali
 Double arm for poles

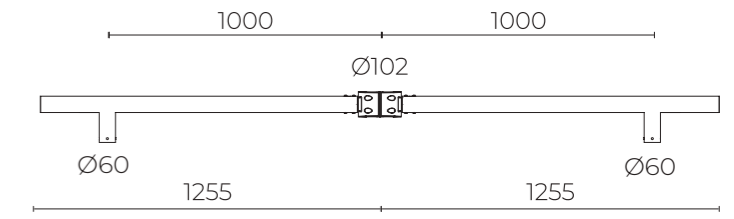

01AK990C0
B214 - Braccio per pali
 Arm for poles

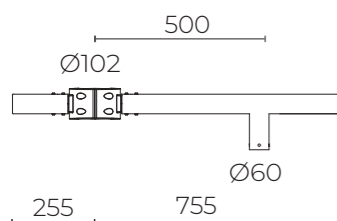

01AK991C0
B215 - Braccio doppio per pali
 Double arm for poles

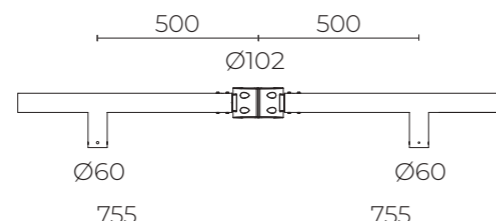

01AK935C0
B15 - Braccio pastorale per pali
 Curved arm for poles

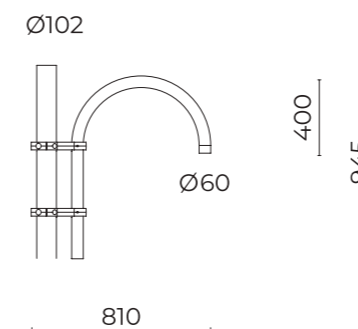

01AK936C0
B16 - Braccio pastorale doppio per pali
 Double curved arm for poles

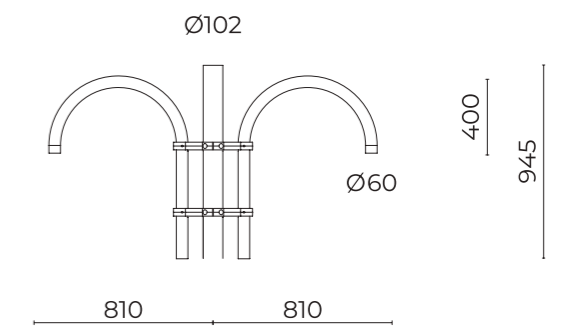

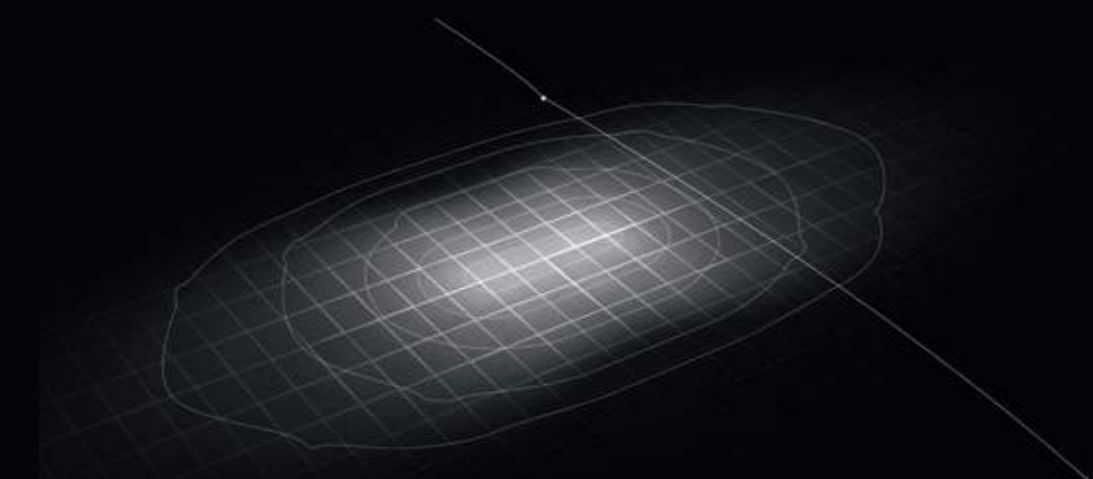

Volta
Sospensione tesata
String suspension



SMALL

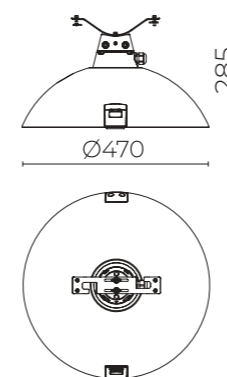

MEDIUM

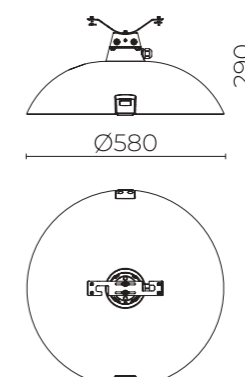

DATI TECNICI / TECHNICAL DATA

Installazione / Installation:

sospensione tesata per fune Ø 6 ÷ 12 mm. Su richiesta versione entra-esci
suspension for string Ø 6 ÷ 12 mm. On request in-out version

Inclinazione / Inclination:

orizzontale ±15° / horizontal ±15°

Orientabilità / Adjustability:

0° ÷ 360°



ST-02 Narrow Street
L / H = 0,75

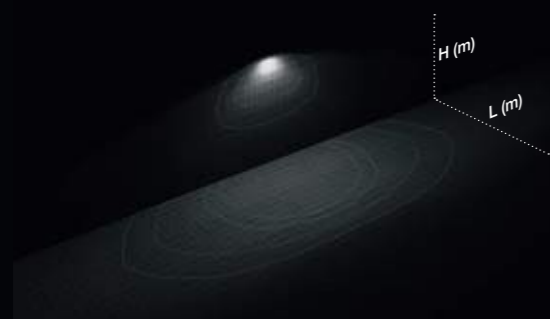

LA-03 Wide Street
L / H = 1,25



ME-05 Medium Street
L / H = 1

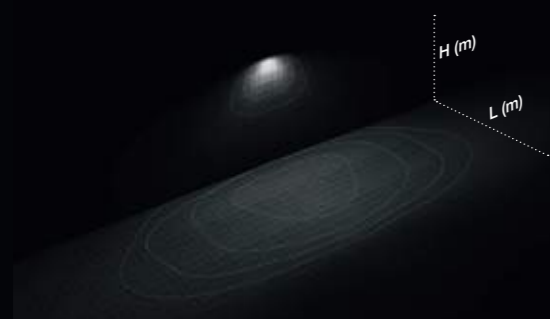

LT-63 Asymmetric Beam
L / H = 2

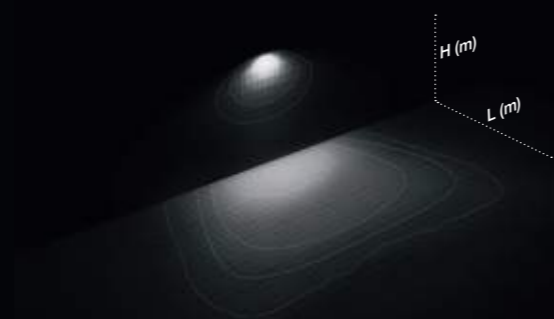

SMALL

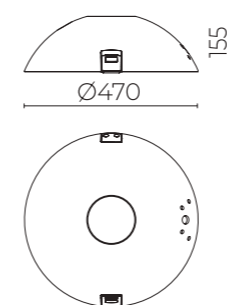
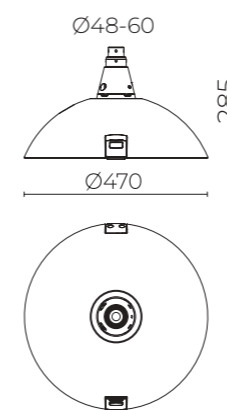

MEDIUM

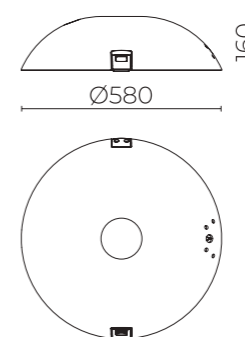
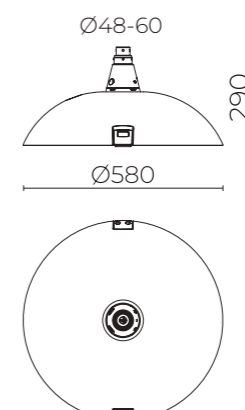

DATI TECNICI / TECHNICAL DATA

Installazione / Installation:
parete / wall-mounted



Volta

Volta

Parete / Wall

ACCESSORI E BRACCI / ACCESSORIES AND ARMS

01V0901C0

L17 - Kit laterale fisso per braccio

Fixed side kit for arm

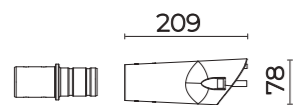

01V0902C0

L16 - Kit laterale regolabile

per palo o braccio

Adjustable side kit for pole or arm



01AK982C0

B206-P - Braccio a parete laterale

Side wall-mounting arm

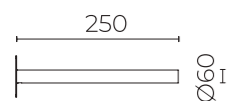

01AK983C0

B207-P - Braccio a parete sospensione

Suspension wall-mounting arm

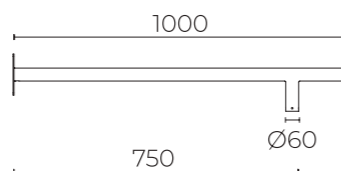

01AK950C0

B15-P - Braccio pastorale a parete

Curved arm for wall

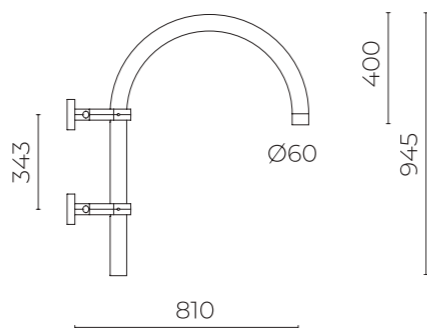

OTTICHE / OPTICS

RS-02 Rotosymmetric Beam



Volta
Sottoportico / Arcade



SMALL

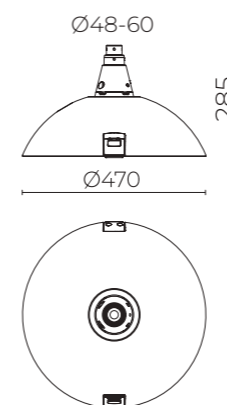

MEDIUM

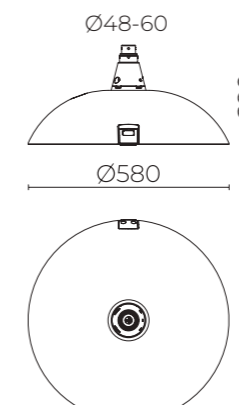

DATI TECNICI / TECHNICAL DATA

Installazione / Installation:
sottoportico / arcade

ACCESSORI / ACCESSORIES

01KA915CO

B53 - Kit sospensione sottoportico
Arcade suspension kit

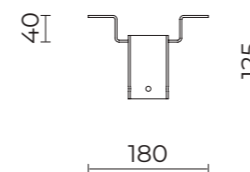

THEMELIO

L'ampia gamma di soluzioni ottiche e di fissaggi a sospensione rende THEMELIO ideale per l'illuminazione di spazi e percorsi urbani in ogni città.

A wide range of optical and suspension fastening solutions makes THEMELIO ideal for lighting urban spaces and pathways in any city.





220 240V	50 60Hz	CL II	IP66	IK09	ta -30°C +50°C
-------------	------------	-------	------	------	----------------------



DATI PRESTAZIONALI / PERFORMANCE DATA

Flusso apparecchio / Fitting flux:
1355 (1800 K) - 23180 lm

Potenza apparecchio / Fitting power:
12 - 155 W

Indice di resa cromatica / Colour Rendering Index:
CRI ≥ 70, SDCM ≤ 3

Illuminazione intelligente / Smart Lighting:
mezzanotte virtuale. Su richiesta ZHAGA, DALI, CLO, PLC,
telegestione wireless
virtual midnight. On request ZHAGA, DALI, CLO, PLC,
wireless telemanagement

MATERIALI / MATERIALS

Corpo e sistemi di fissaggio / Body and fitting system:
pressofusione di lega d'alluminio UNI EN AB 47100
(contenuto rame < 1%) / die-cast aluminum alloy UNI EN
AB 47100 (copper content < 1%)

Schermo / Screen:
vetro piano temprato / tempered flat glass

Gruppo ottico / Optical unit:
lenti PMMA ad alta trasparenza
high-transparency PMMA lenses

Finitura / Finish:
fosfocromatazione e verniciatura in polveri di poliestere
realizzata in 16 fasi per la miglior resistenza agli
agenti atmosferici / phospho-chromatation treated
and polyester powder-coated in 16 phases to increase
weather resistance

TEMPERATURA COLORE COLOUR TEMPERATURE

- 2200 K
- 2700 K
- 3000 K
- 4000 K

ECO-CENTRIC LIGHTING (ECL)

(ONLY FOR STREET OPTICS)

BLUE FREE LIGHT:
PC-AMBER 0,7% $\sum R$ ($\lambda < 500\text{NM}$) – CRI 40
1800 K 4,3% $\sum R$ ($\lambda < 500\text{NM}$) – CRI 70

SWITCHABLE WHITE LIGHT:
1800K / 3000K

COLORI / COLOURS

- SABLÉ 100 NOIR

* Sistema a sospensione / Suspension system

** Corpo / Body



CARATTERISTICHE / FEATURES

Configurazione / Configuration:
il prodotto si compone di corpo e sistema a sospensione,
da ordinare separatamente / product composed of body
and suspension system, to be ordered separately

Peso massimo / Max weight:
8,8 kg (small), 14,3 kg (medium)

Alimentazione elettronica / Electronic power supply:
inclusa / included

Resistenza sovratensioni / Surge Protection Device:
10 kV MC/MD

Precablaggio / Pre-wiring:
prodotto pre-cablato con cavo e connettore
pre-wired product with cable and connector

Installazione / Installation:
sospensione braccio, sospensione tesata, parete,
sottoportico / arm suspension, string suspension,
wall, arcade

OTTICHE / OPTICS

LT-C1 Cycle Path
L / H = 0,5

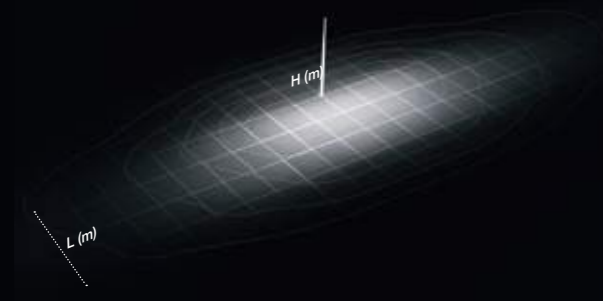

LA-03 Wide Street
L / H = 1,25

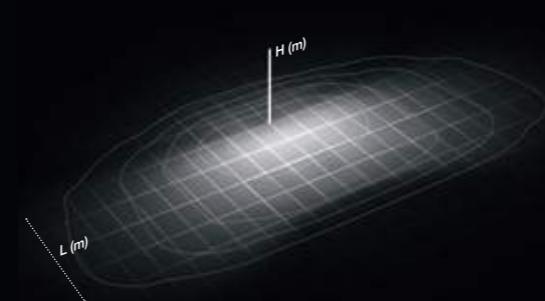

ECL

ST-02 Narrow Street
L / H = 0,75

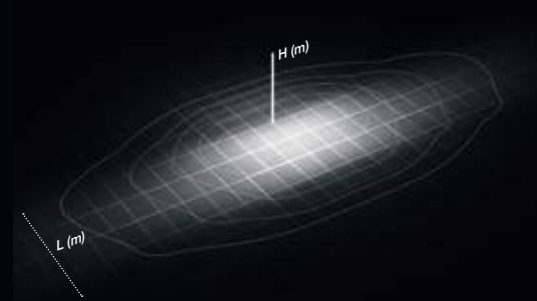

ECL

PB-01 Low Pole
L / H = 2

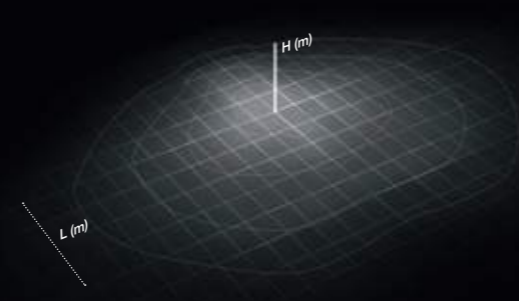

ME-05 Medium Street
L / H = 1

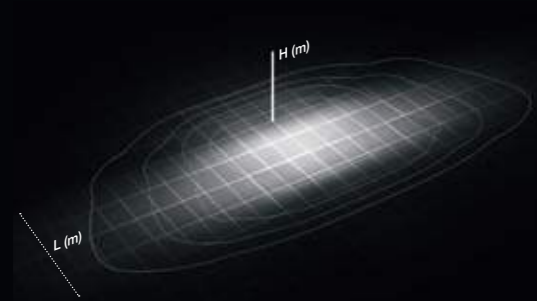

ECL

LT-64 Asymmetric Beam with backlight
L / H = 2

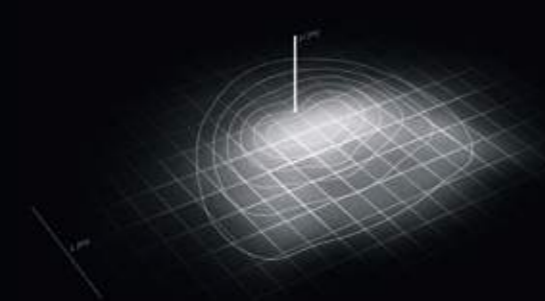

ECL



SMALL

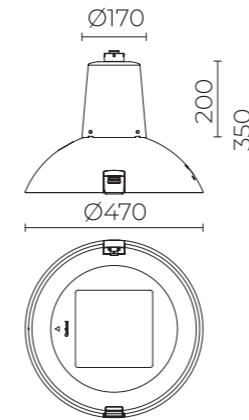

MEDIUM

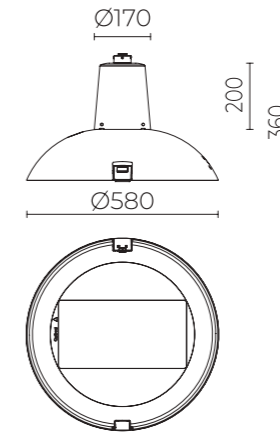

DATI TECNICI / TECHNICAL DATA

Installazione / Installation:
con accessori, su pali Ø 60 - 76 - 102 mm
with accessories, on poles Ø 60 - 76 - 102 mm



Themelio

Sospensione braccio / Arm suspension

ACCESSORI E BRACCI / ACCESSORIES AND ARMS

01TH900CO
Sospensione 3/4" GAS
 3/4" GAS suspension

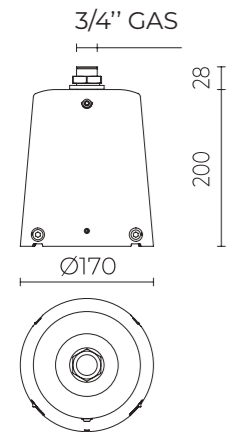

01TH903CO
Sospensione carrucola
 Pulley suspension

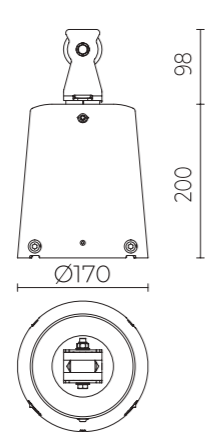

01TH904CO
Sospensione per bracci
 Suspension for arms

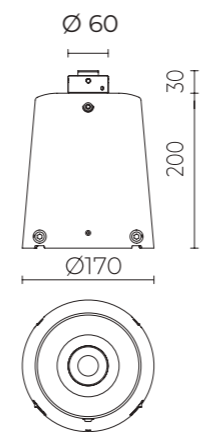

01AK988CO
B212 - Braccio per pali
 Arm for poles

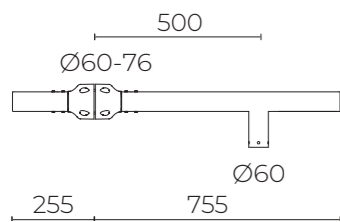

01AK989CO
B213 - Braccio doppio per pali
 Double arm for poles

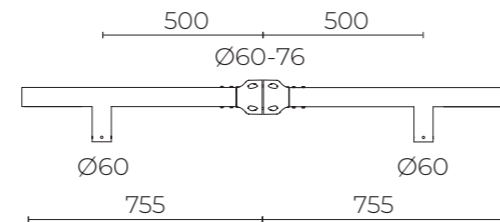

01AK990CO
B214 - Braccio per pali
 Arm for poles

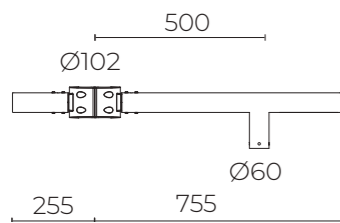

01AK991CO
B215 - Braccio doppio per pali
 Double arm for poles

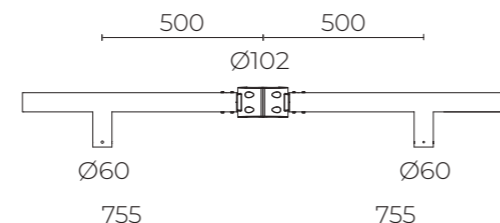

01AK992CO
B216 - Braccio per pali
 Arm for poles

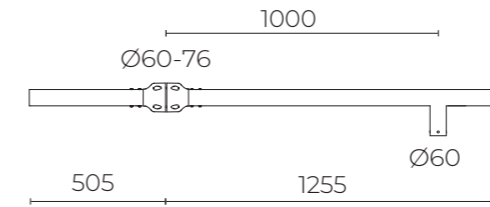

01AK994CO
B217 - Braccio doppio per pali
 Double arm for poles

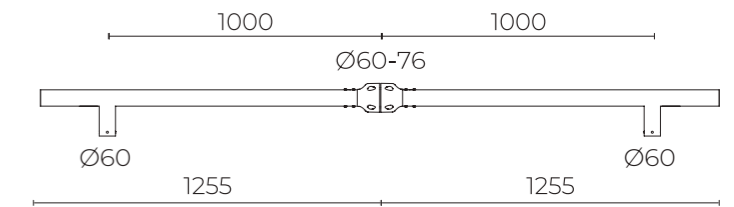

01AK995CO
B218 - Braccio per pali
 Arm for poles

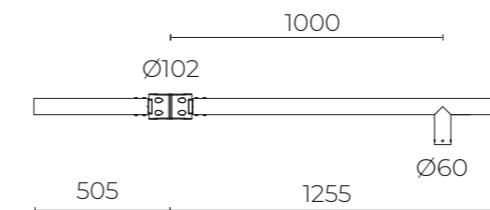

01AK996CO
B219 - Braccio doppio per pali
 Double arm for poles

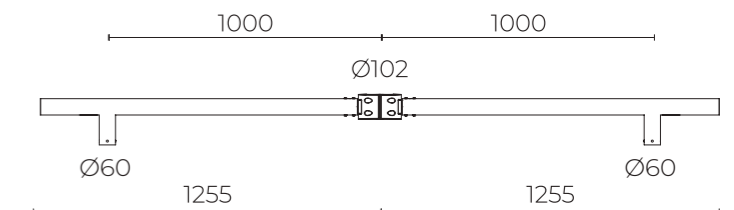

01AK935CO
B15 - Braccio pastorale per pali
 Curved arm for poles

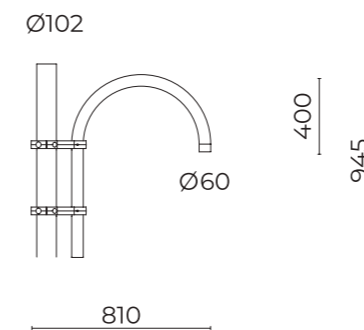

01AK936CO
B16 - Braccio pastorale doppio per pali
 Double curved arm for poles

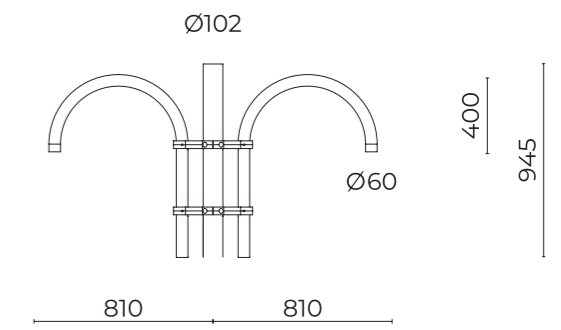

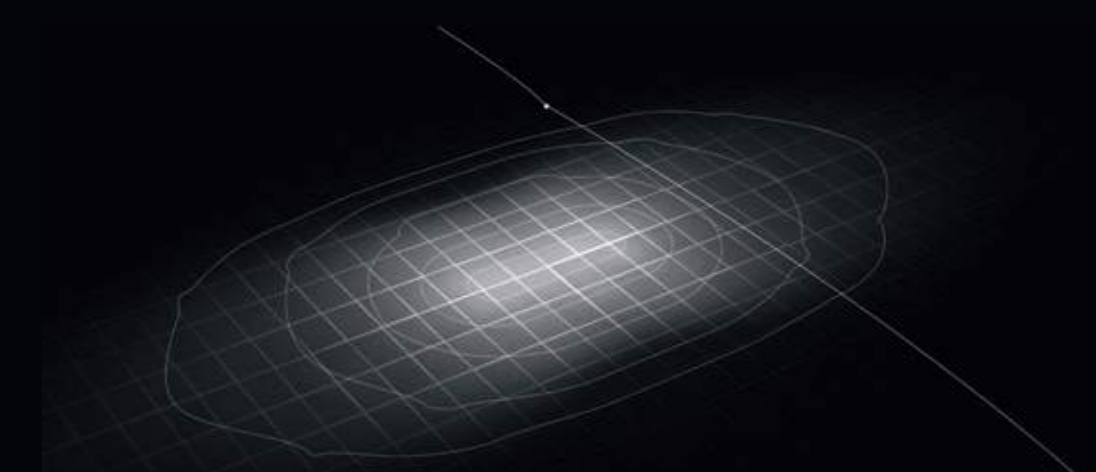

Themelio
Sospensione tesata
String suspension



SMALL

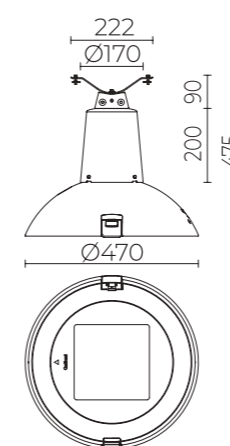

MEDIUM

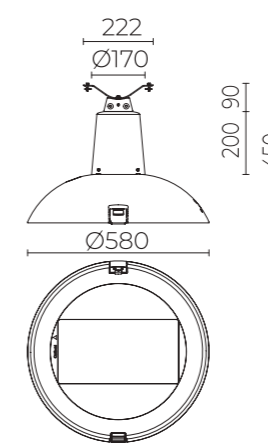

DATI TECNICI / TECHNICAL DATA

Installazione / Installation:
sospensione tesata / suspension for string

Inclinazione / Inclination:
orizzontale $\pm 15^\circ$ / horizontal $\pm 15^\circ$

Orientabilità / Adjustability:
 $0^\circ \div 360^\circ$

ACCESSORI / ACCESSORIES

01TH901CO

Sospensione tesata per fune $\text{Ø } 6 \div 12 \text{ mm}$
Suspension for string $\text{Ø } 6 \div 12 \text{ mm}$

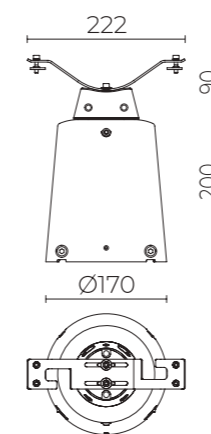

ST-02 Narrow Street
L / H = 0,75

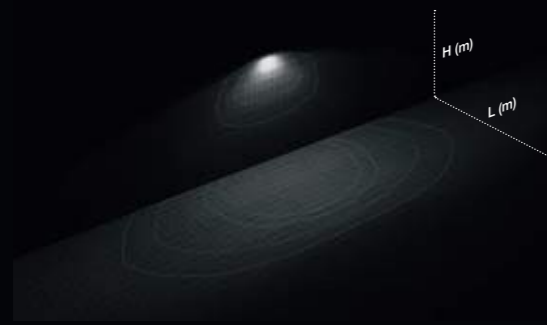

LA-03 Wide Street
L / H = 1,25



ME-05 Medium Street
L / H = 1



LT-63 Asymmetric Beam
L / H = 2

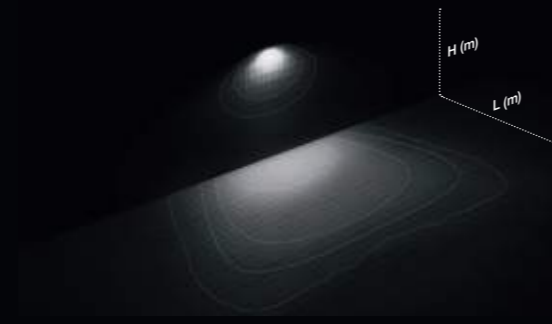

SMALL

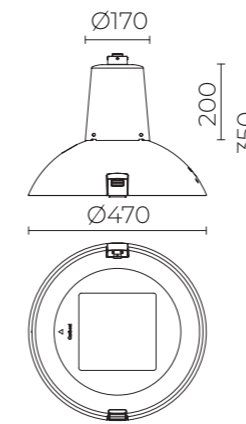

MEDIUM

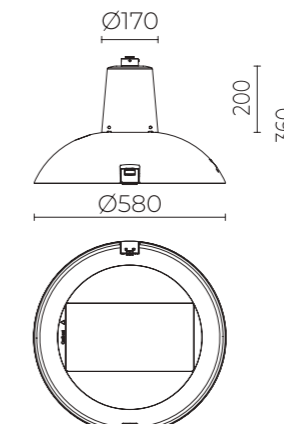

DATI TECNICI / TECHNICAL DATA

Installazione / Installation:
parete / wall-mounted



Themelio
Parete / Wall

ACCESSORI E BRACCI / ACCESSORIES AND ARMS

01TH900C0
Sospensione 3/4" GAS
3/4" GAS suspension

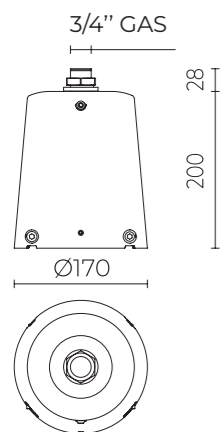

01TH903C0
Sospensione carrucola
Pulley suspension

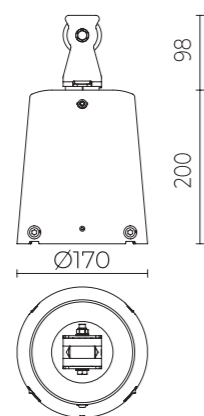

01TH904C0
Sospensione per bracci
Suspension for arms

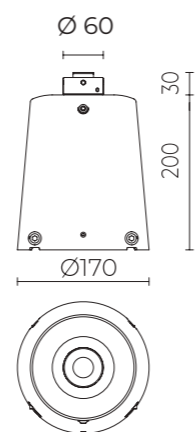

01AK983C0
B207-P - Kit attacco a parete sospensione
Suspension wall-mounting kit

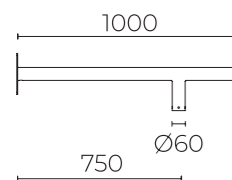

01AK950C0
B1-P - Braccio pastorale a parete
Curved arm for wall

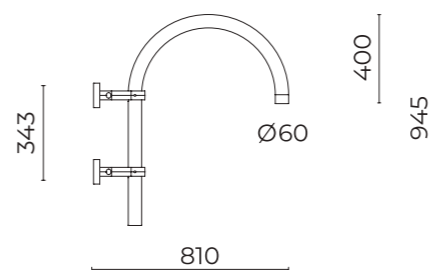

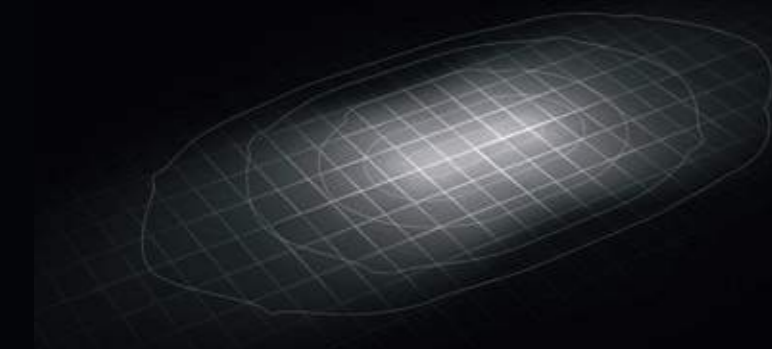

Themelio
Soffitto / Ceiling



SMALL

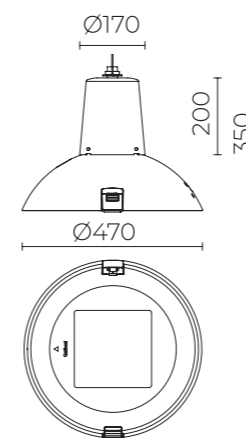

MEDIUM

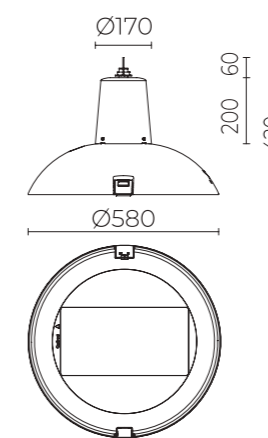

DATI TECNICI / TECHNICAL DATA

Installazione / Installation:
sottoportico / arcade

ACCESSORI / ACCESSORIES

01TH902C0

Sospensione per catena (non inclusa)
Suspension for chain (not included)

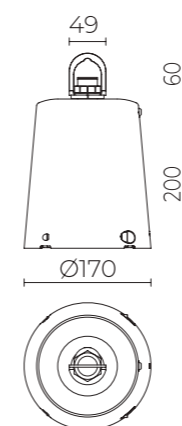

01TH905C0

Sospensione sottoportico
Arcade suspension

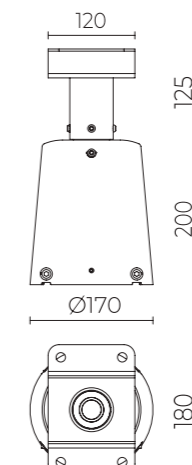

NODEA



NODEA è una lanterna urbana moderna,
disegnata dall'architetto e lighting designer
François Migeon per l'illuminazione di percorsi e
spazi urbani.

NODEA is a modern urban lantern, designed by
the architect and lighting designer François
Migeon for lighting urban pathways and spaces.

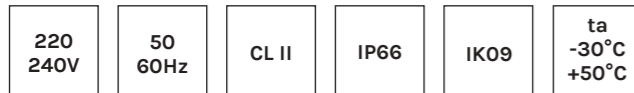

DATI PRESTAZIONALI / PERFORMANCE DATA

Flusso apparecchio / Fitting flux:
1230 - 5540 lm

Potenza apparecchio / Fitting power:
12 - 37 W

Indice di resa cromatica / Colour Rendering Index:
CRI ≥ 70, SDCM ≤ 3

Illuminazione intelligente / Smart lighting:
mezzanotte virtuale. Su richiesta DALI
virtual midnight. On request DALI

TEMPERATURA COLORE COLOUR TEMPERATURE

- 2700 K
- 3000 K
- 4000 K

MATERIALI / MATERIALS

Corpo / Body:
pressofusione di lega d'alluminio UNI EN AB 47100
(contenuto rame < 1%) / die-cast aluminum alloy UNI EN
AB 47100 (copper content < 1%)

Schermo / Screen:
vetro piano temprato / tempered flat glass

Gruppo ottico / Optical unit:
lenti PMMA ad alta trasparenza
high-transparency PMMA lenses

Finitura / Finish:
fosfocromatazione e verniciatura in polveri di poliestere
realizzata in 16 fasi per la miglior resistenza agli
agenti atmosferici / phospho-chromatation treated
and polyester powder-coated in 16 phases to increase
weather resistance

COLORI / COLOURS

- SABLÉ 100 NOIR

CARATTERISTICHE / FEATURES

Peso massimo / Max weight:
4,5 kg

Alimentazione elettronica / Electronic power supply:
inclusa / included

Resistenza sovratensioni / Surge Protection Device:
10 kV MC/MD

Precablaggio / Pre-wiring:
prodotto pre-cablato con cavo e connettore
pre-wired product with cable and connector

Installazione / Installation:
lato palo / pole side



OTTICHE / OPTICS

ME-05 Medium Street
L / H = 1

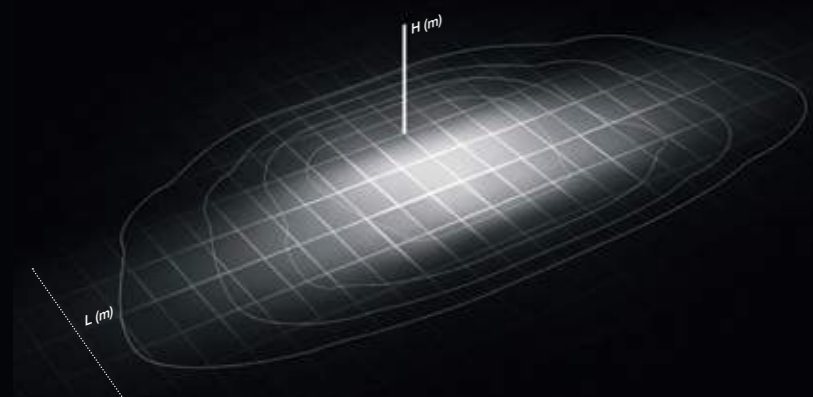

LT-64 Asymmetric Beam with backlight
L / H = 2

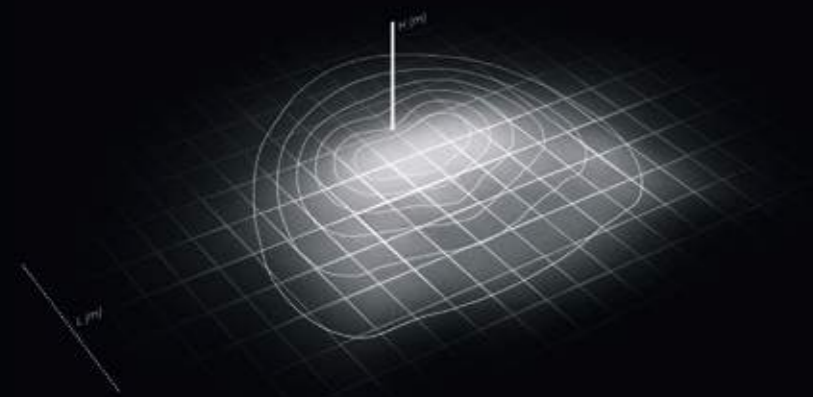

Nodea

Lato palo / Pole side

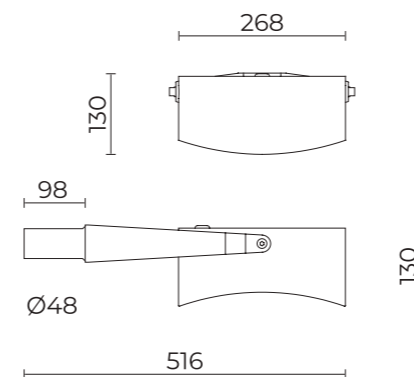

DATI TECNICI / TECHNICAL DATA

Installazione / Installation:
braccio Ø 48 mm / arm Ø 48 mm

Inclinazione / Inclination:
regolazione continua / continuous adjustment

ACCESSORI / ACCESSORIES

06ND901Y0
Diffusore policarbonato trasparente
Transparent polycarbonate diffuser

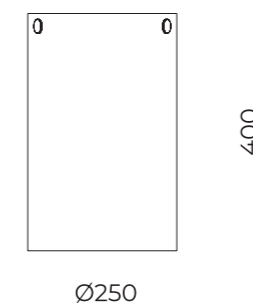

ORAO

ORAO è stato pensato per il benessere degli abitanti degli spazi urbani. Geometrie e finiture migliorano il comfort visivo garantendo le performance fotometriche del sistema ottico.

ORAO was designed for the well-being of inhabitants in urban areas. Its shapes and finishes enhance visual comfort without compromising the photometric performance of the optical system.

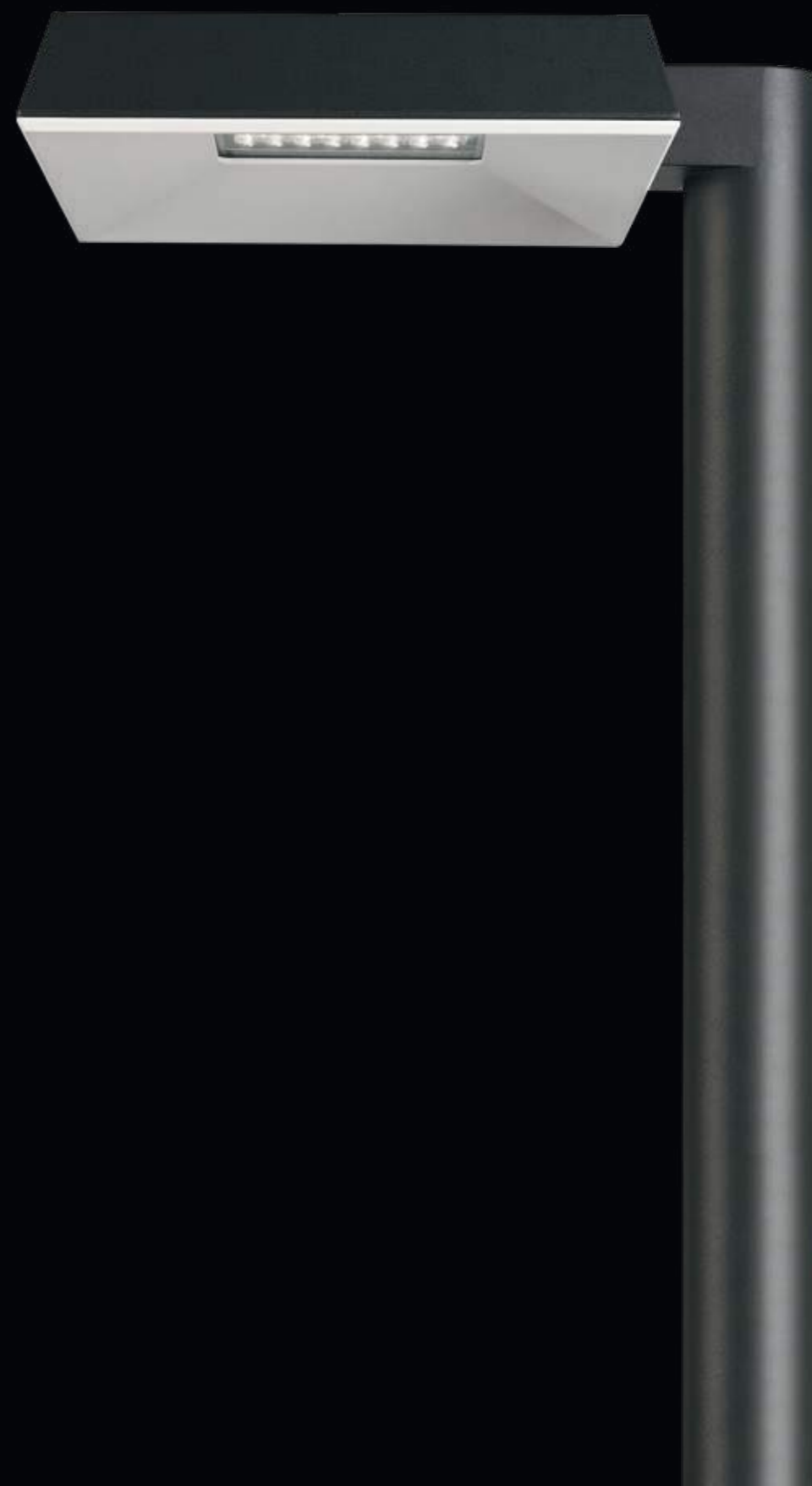

220 240V	50 60Hz	CL II	IP66	IK09	ta -30°C +50°C
-------------	------------	-------	------	------	----------------------



DATI PRESTAZIONALI / PERFORMANCE DATA

Flusso apparecchio / Fitting flux:
1230 - 23180 lm

Potenza apparecchio / Fitting power:
12 - 155 W

Indice di resa cromatica / Colour Rendering Index:
CRI ≥ 70, SDCM ≤ 3

Illuminazione intelligente / Smart lighting:
mezzanotte virtuale. Su richiesta ZHAGA, DALI, CLO, PLC,
telegestione wireless / virtual midnight. On request
ZHAGA, DALI, CLO, PLC, wireless telemanagement

TEMPERATURA COLORE COLOUR TEMPERATURE

- 2700 K
- 3000 K
- 4000 K

MATERIALI / MATERIALS

Corpo e sistemi di fissaggio / Body and fitting system:
pressofusione di lega d'alluminio UNI EN AB 47100
(contenuto rame < 1%) / die-cast aluminum alloy UNI EN AB
47100 (copper content < 1%)

Schermo / Screen:
vetro piano temprato / tempered flat glass

Gruppo ottico / Optical unit:
lenti PMMA ad alta trasparenza
high-transparency PMMA lenses

Finitura / Finish:
fosfocromatazione e verniciatura in polveri di poliestere
realizzata in 16 fasi per la miglior resistenza agli agenti
atmosferici / phospho-chromatation treated and polyester
powder-coated in 16 phases to increase weather resistance

COLORI / COLOURS

- SABLÉ 100 NOIR



CARATTERISTICHE / FEATURES

Peso massimo / Max weight:
7.5 kg (small), 12 kg (medium)

Alimentazione elettronica / Electronic power supply:
inclusa / included

Resistenza sovratensioni / Surge Protection Device:
10 kV MC/MD

Precablaggio / Pre-wiring:
prodotto pre-cablato con cavo e connettore
pre-wired product with cable and connector

Installazione / Installation:
lato palo, sospensione tesata, parete, sottoportico
pole side, string suspension, wall, arcade

OTTICHE / OPTICS

LT-C1 Cycle Path
L / H = 0,5

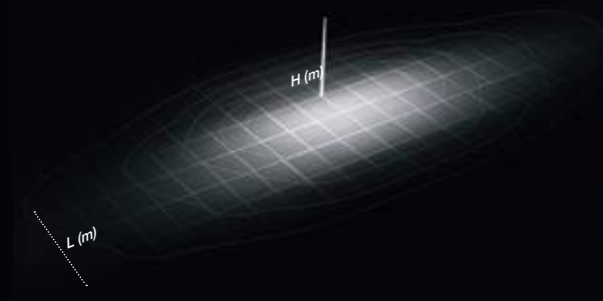

LA-03 Wide Street
L / H = 1,25

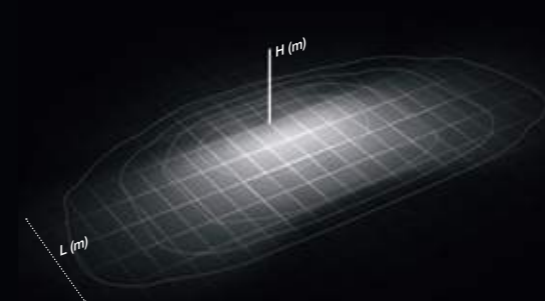

ST-02 Narrow Street
L / H = 0,75

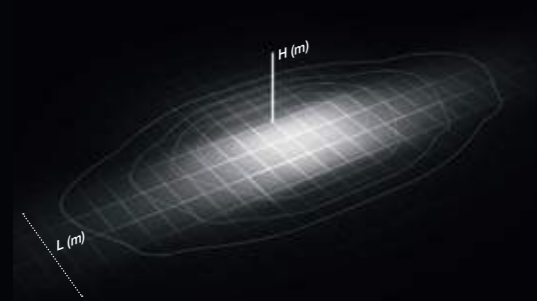

PB-01 Low Pole
L / H = 2

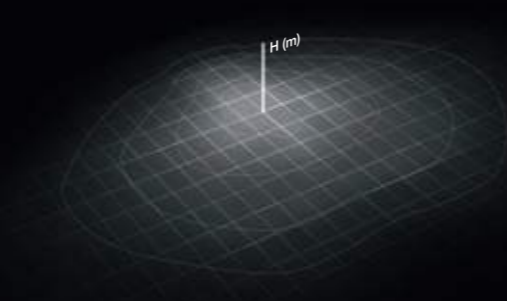

ME-05 Medium Street
L / H = 1

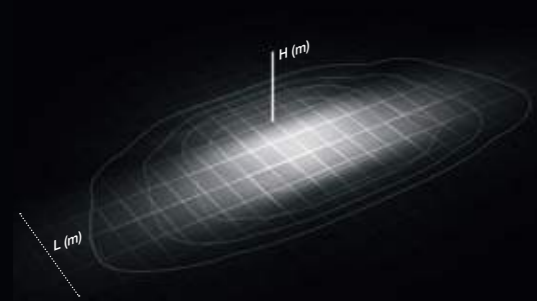

LT-64 Asymmetric Beam with backlight
L / H = 2

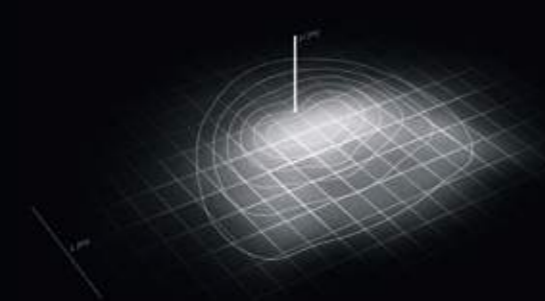

Orao
Lato palo / Pole side



SMALL

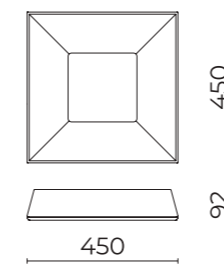

MEDIUM

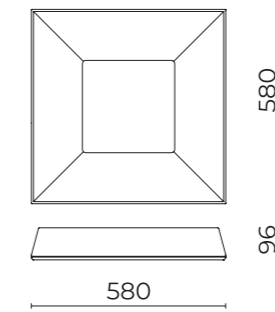

DATI TECNICI / TECHNICAL DATA

Installazione / Installations:
con accessorio 01OR901CO su pali Ø 102 mm;
con bracci su pali Ø 60 - 76 - 102 mm / with
accessory 01OR901CO on poles Ø 102 mm; with
arms for poles Ø 60 - 76 - 102 mm

01OR901CO
B96 - Attacco testa palo Ø 60 mm H 90 mm
Joint for post top Ø 60 mm H 90 mm

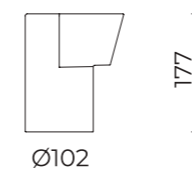

Orao

Lato palo / Pole side

BRACCI / ARMS

01OR904C0
B99 - Braccio rettangolare
Rectangular arm

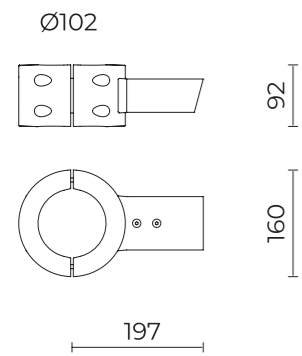

01OR905C0
B100 - Braccio doppio rettangolare
Rectangular double arm

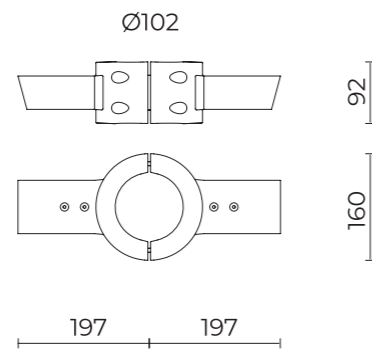

01OR906C0
B101 - Braccio rettangolare
Rectangular arm

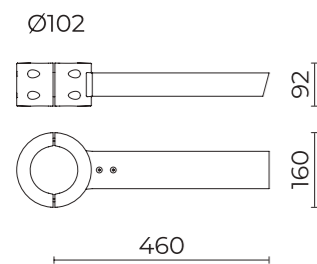

01OR907C0
B102 - Braccio doppio rettangolare
Rectangular double arm

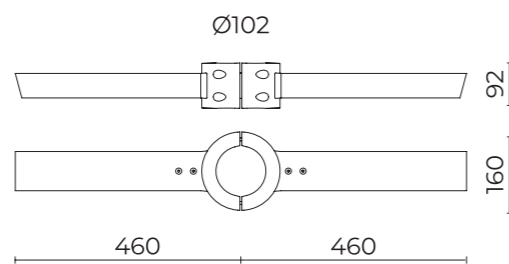

01OR908C0
B103 - Braccio rettangolare
Rectangular arm

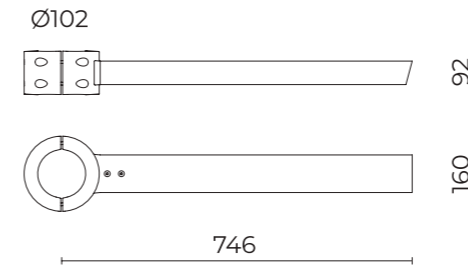

01OR909C0
B104 - Braccio doppio rettangolare
Rectangular double arm

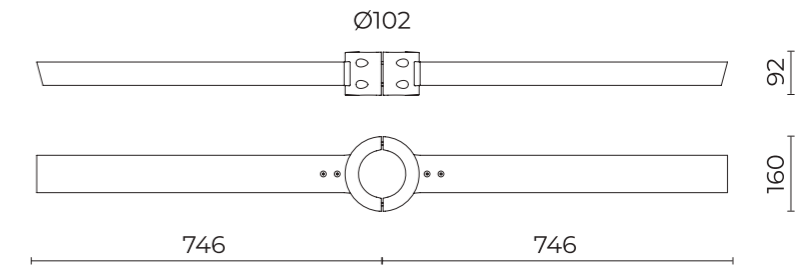

01OR911C0
B106 - Braccio tubolare
Tubular arm

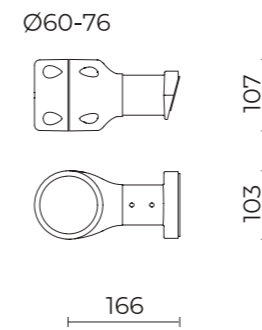

01OR912C0
B107 - Braccio doppio tubolare
Tubular double arm

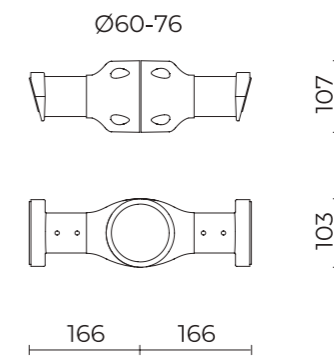

01OR913C0
B108 - Braccio tubolare
Tubular arm

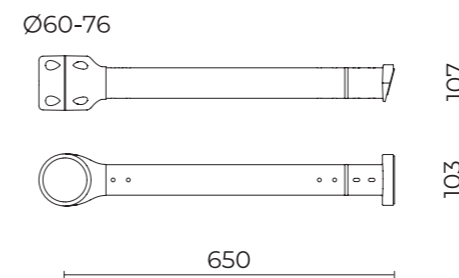

01OR914C0
B109 - Braccio doppio tubolare
Tubular double arm

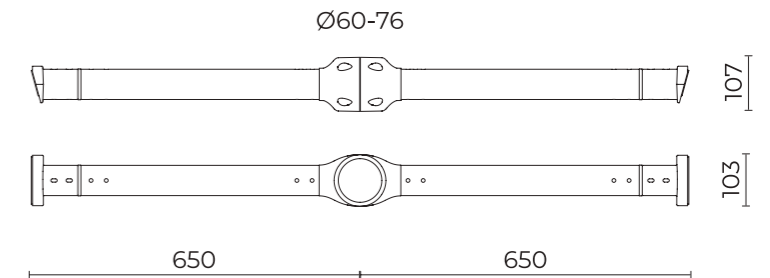

01OR903C0
B98-P - Braccio parete
Arm for wall

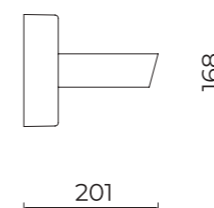

01OR916C0
B83 - Attacco sospensione pastorale
Kit for suspension on curved arm

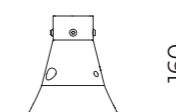



CENTELLES
Spain



FIDENZA
Italy

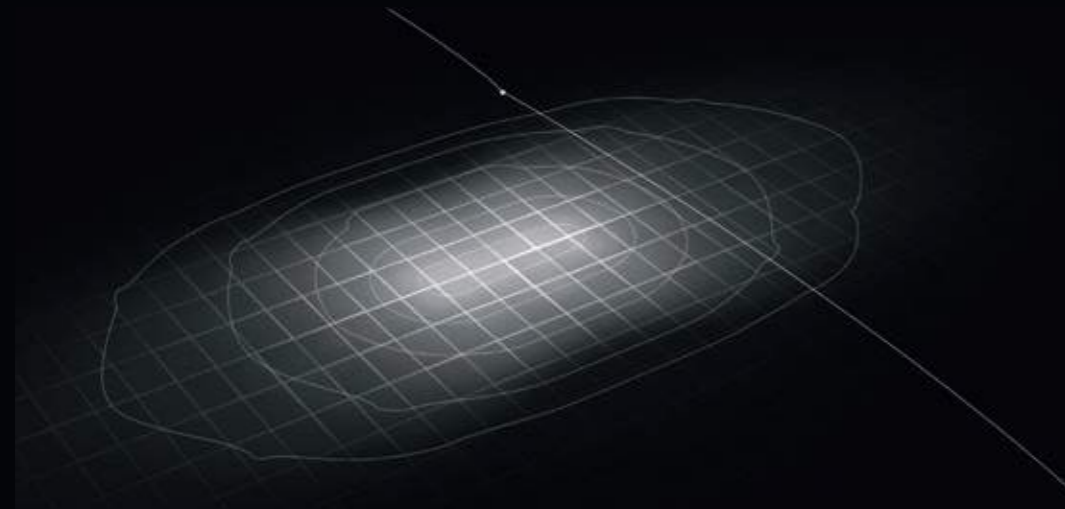

Orao
Sospensione tesata
String suspension



SMALL

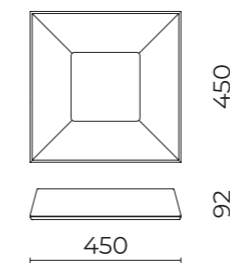

MEDIUM

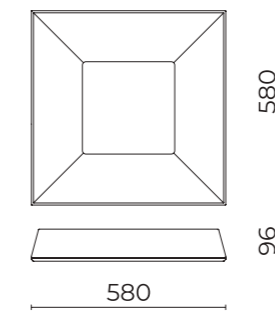

DATI TECNICI / TECHNICAL DATA

Installazione / Installation:
sospensione tesata / string suspension

Inclinazione / Inclination:
orizzontale $\pm 15^\circ$ / horizontal $\pm 15^\circ$

Orientabilità / Adjustability:
 $0^\circ \div 360^\circ$

ACCESSORI / ACCESSORIES

01OR915CO
B82 - Kit sospensione fune tesata $\varnothing 6 \div 12$ mm
Suspension kit for string $\varnothing 6 \div 12$ mm

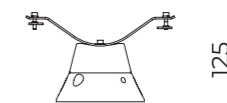



FLAT LINK

L'ampia gamma di soluzioni ottiche e di fissaggio rendono FLAT LINK una soluzione ideale per l'illuminazione di spazi e percorsi urbani in ogni città. Design by Silvio De Ponte.

The wide range of optical and installation solutions make FLAT LINK an ideal solution for lighting urban spaces and pathways in every city. Design by Silvio De Ponte.

220 240V	50 60Hz	CL II	IP66	IK08	ta -30°C +50°C
-------------	------------	-------	------	------	----------------------



DATI PRESTAZIONALI / PERFORMANCE DATA

Flusso apparecchio / Fitting flux:
3720 - 17140 lm

Potenza apparecchio / Fitting power:
26,5 - 128,5 W

Indice di resa cromatica / Colour Rendering Index:
CRI ≥ 70, SDCM ≤ 4

Illuminazione intelligente / Smart Lighting:
mezzanotte virtuale. Su richiesta ZHAGA, DALI, CLO, PLC,
telegestione wireless
virtual midnight. On request ZHAGA, DALI, CLO, PLC,
wireless telemanagement

MATERIALI / MATERIALS

Corpo e sistemi di fissaggio / Body and fitting system:
pressofusione di lega d'alluminio UNI EN AB 47100
(contenuto rame < 1%) / die-cast aluminum alloy UNI EN
AB 47100 (copper content < 1%)

Copertura / Upper dome:
tornitura di lastra di alluminio
aluminium plate turning

Schermo / Screen:
vetro piano temprato / tempered flat glass

Gruppo ottico / Optical unit:
lenti PMMA ad alta trasparenza
high-transparency PMMA lenses

Finitura / Finish:
fosfocromatazione e verniciatura in polveri di poliestere
realizzata in 16 fasi per la miglior resistenza agli
agenti atmosferici / phospho-chromatation treated
and polyester powder-coated in 16 phases to increase
weather resistance

TEMPERATURA COLORE COLOUR TEMPERATURE

- 3000 K
- 4000 K

COLORI / COLOURS

- SABLÉ 100 NOIR



CARATTERISTICHE / FEATURES

Peso massimo / Max weight:
11 kg

Alimentazione elettronica / Electronic power supply:
inclusa / included

Resistenza sovratensioni / Surge Protection Device:
10 kV MC/MD

Precablaggio / Pre-wiring:
prodotto pre-cablato con cavo e connettore
pre-wired product with cable and connector

Installazione / Installation:
lato palo, sospensione braccio, sospensione tesata,
parete / pole side, arm suspension, string
suspension, wall

OTTICHE / OPTICS

ST-01 Narrow Street
L / H = 0,75

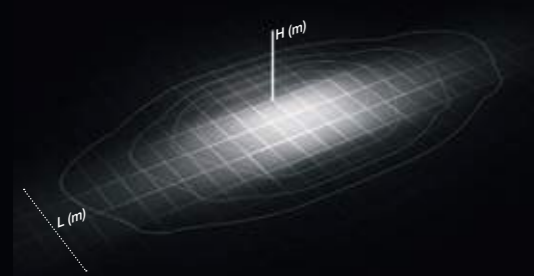

LA-01 Wide Street
L / H = 1,25

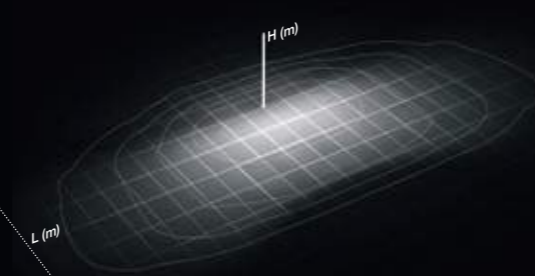

ME-01 Medium Street
L / H = 1

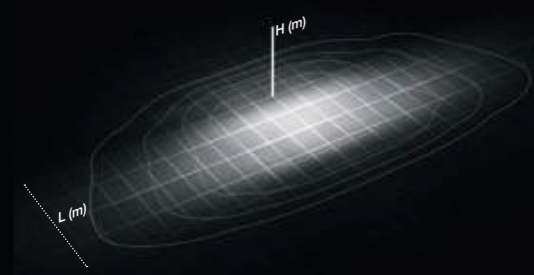

LT-06 Asymmetric Beam
L / H = 2

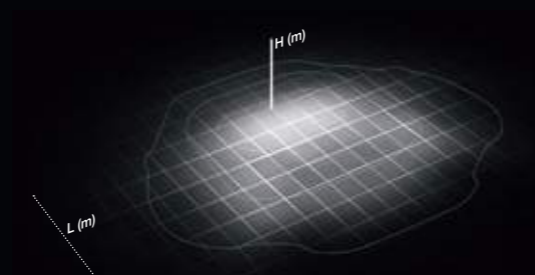

Flat Link
Lato palo / Pole side

DATI TECNICI / TECHNICAL DATA

Installazione / Installation:
con accessori su bracci Ø 48 - 60 mm per
pali Ø 60 - 76 - 102 - 114 mm. Con accessorio
01AK902C0 su pali Ø 60 mm
with accessories on arms Ø 48 - 60 mm for
poles Ø 60 - 76 - 102 - 114 mm. With accessory
01AK902C0 on poles Ø 60 mm

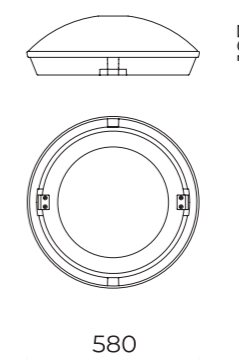

ACCESSORI / ACCESSORIES

01AK901C0
L1 - Kit laterale fisso
per braccio
Fixed side kit for arm

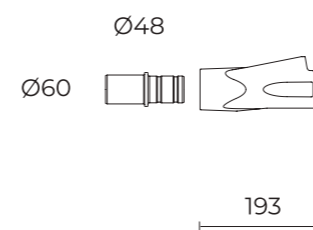

01AK902C0
L2 - Kit laterale regolabile
per palo o braccio
Adjustable side kit for pole or arm

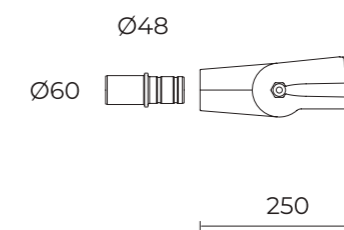

01AK903C0
L3 - Kit giunto
per palo o braccio
Joint kit for pole or arm

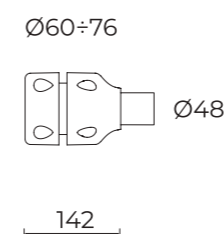

01AK904C0
L4 - Kit giunto doppio
per palo o braccio
Double joint kit for pole or arm

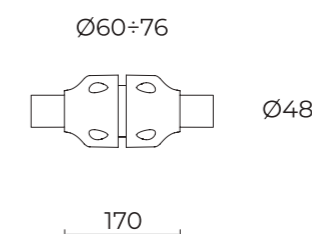

Flat Link

Lato palo / Pole side

ACCESSORI E BRACCI / ACCESSORIES AND ARMS

06AK905CO
B153 - Giunto testa palo H 90 mm
 Joint post top H 90 mm

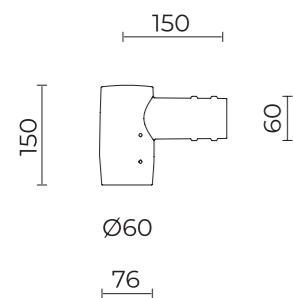

01SC904ADO
E1 - Kit esagono 1 - 2 agganci 180°
 per palo Ø 114 mm
 Hexagonal connector kit 1 - 2 180°
 couplings for a Ø 114 mm pole

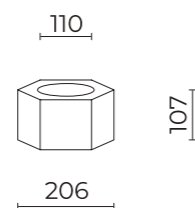

06AK906CO
B154 - Braccio per pali
 Arm for poles

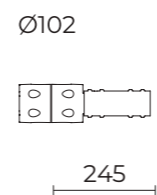

06AK908CO
B156 - Braccio doppio per pali
 Double arm for poles

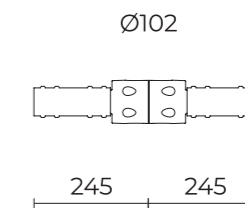

01AK921CO
B1 - Braccio per pali
 Arm for poles

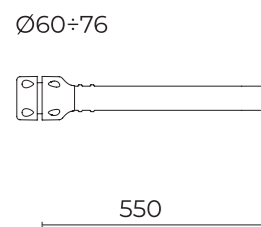

01AK922CO
B2 - Braccio doppio per pali
 Double arm for poles

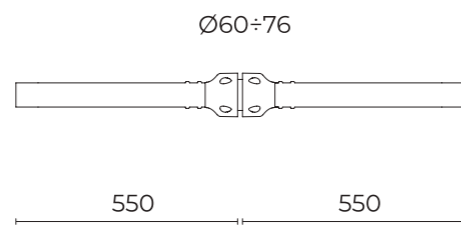

06AK907CO
B155 - Braccio per pali
 Arm for poles

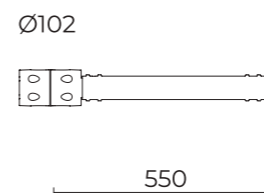

06AK909CO
B157 - Braccio doppio per pali
 Double arm for poles

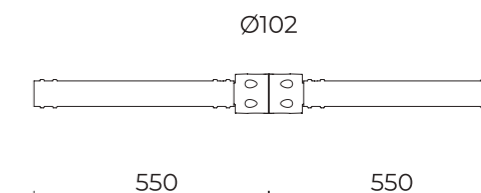

01AK923CO
B3 - Braccio con tirante per pali
 Arm with tensioning rod for poles

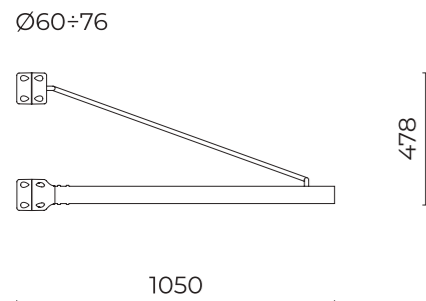

01AK924CO
B4 - Braccio doppio con tirante per pali
 Double arm with tensioning rod for poles

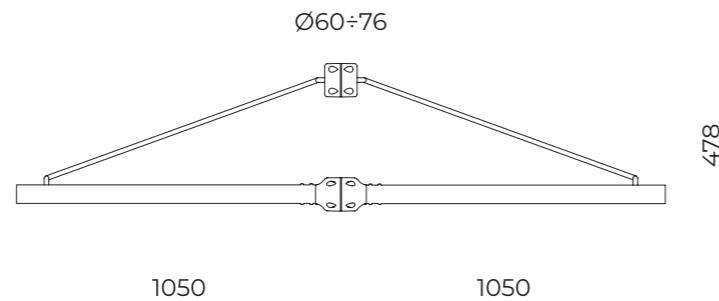

01AK931CO
B11 - Braccio lavorato per pali
 Arm machined for poles

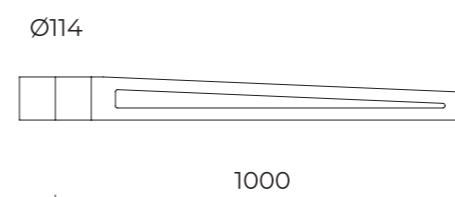

01AK951CO
B1-P - Braccio parete
 Arm for wall

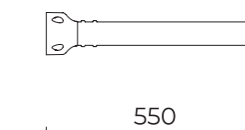

ST-01 Narrow Street
L / H = 0,75

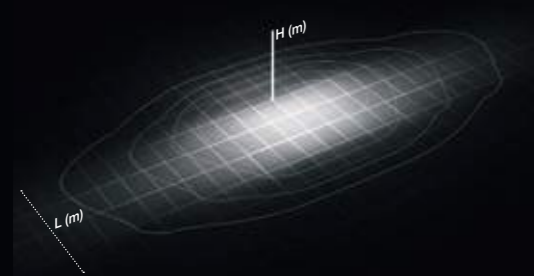

LA-01 Wide Street
L / H = 1,25

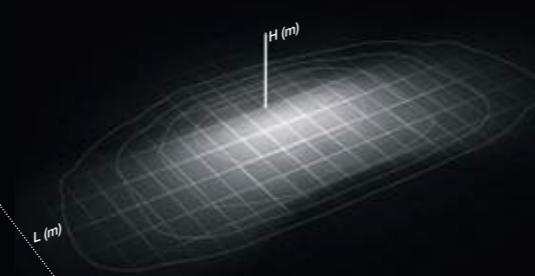

ME-01 Medium Street
L / H = 1

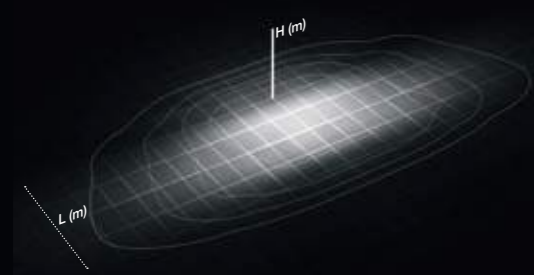

LT-06 Asymmetric Beam
L / H = 2

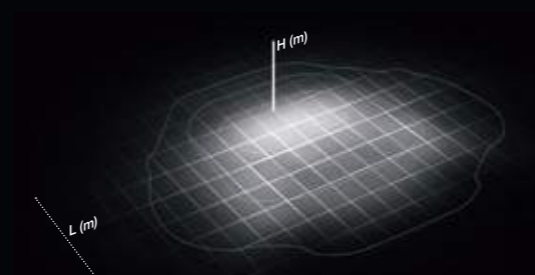

Flat Link

Sospensione braccio / Arm suspension



DATI TECNICI / TECHNICAL DATA

Installazione / Installation:
con accessori su bracci 1"1/2 GAS, 3/4" GAS; su bracci Ø 48 - 60 mm per pali Ø 60 - 76 - 102 - 114 mm / with accessories on arms 1"1/2 GAS, 3/4" GAS; on arms Ø 48 - 60 mm for poles Ø 60 - 76 - 102 - 114 mm

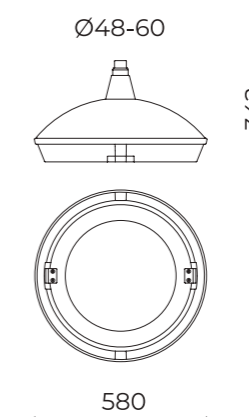

ACCESSORI / ACCESSORIES

01AK907C0
L16 - Kit sospensione maschio
Male suspension kit

1"1/2 GAS



70

Ø48

01AK914C0
L17 - Kit sospensione maschio
Male suspension kit

3/4" GAS

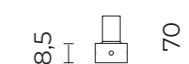

28,5

70

Ø48



Flat Link

Sospensione braccio / Arm suspension

BRACCI / ARMS

01AK933CO

B13 - Braccio ad arco per pali

Arched arm for poles

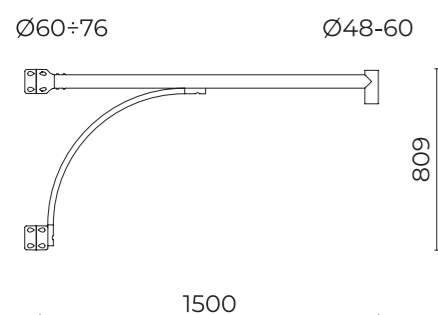

01AK934CO

B14 - Braccio ad arco doppio per pali

Double arched arm for poles

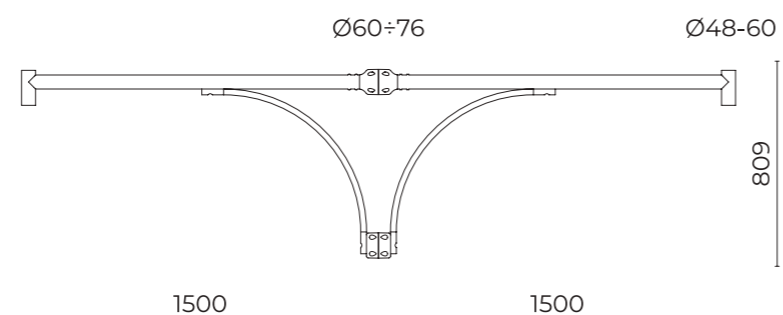

01AK935CO

B15 - Braccio pastorale per pali

Curved arm for poles

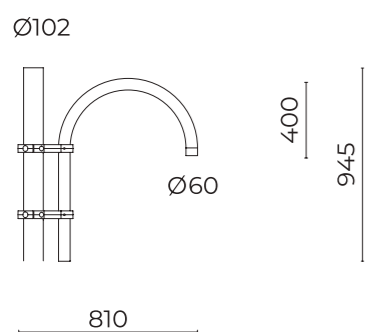

01AK936CO

B16 - Braccio pastorale doppio per pali

Double curved arm for poles

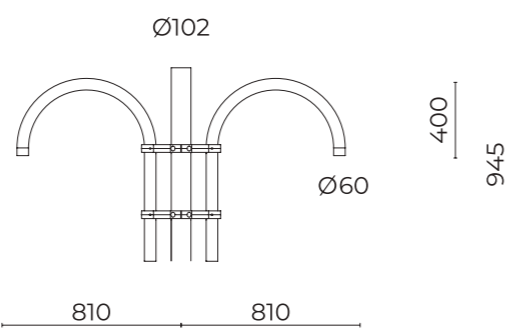

01AK950CO

B15-P - Braccio pastorale a parete

Curved arm for wall

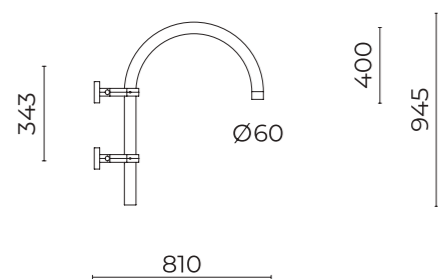

01AK941CO

B21 - Braccio lavorato per pali

Arm machined for poles

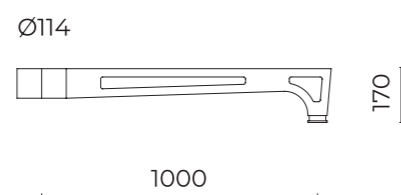

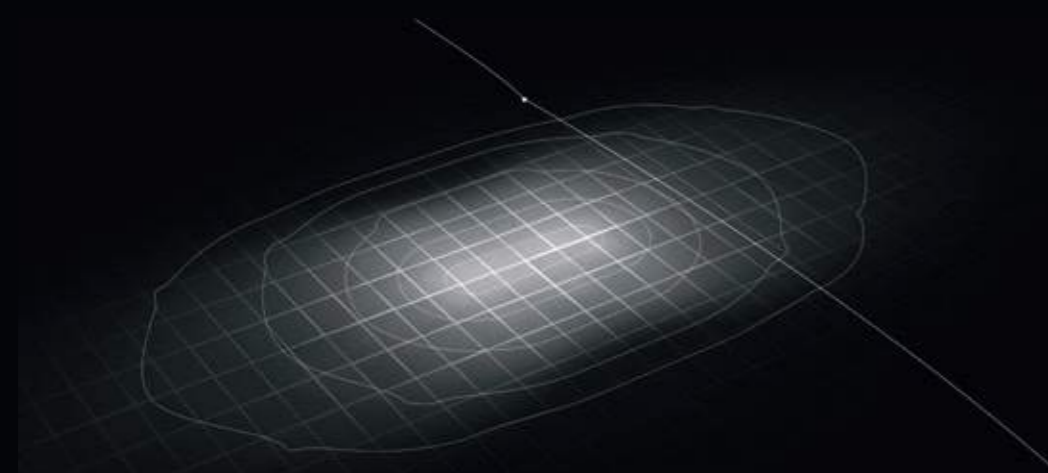

Flat Link
Sospensione tesata
String suspension



DATI TECNICI / TECHNICAL DATA

Installazione / Installation:
sospensione tesata / string suspension

Orientabilità / Adjustability:
0° ÷ 360°

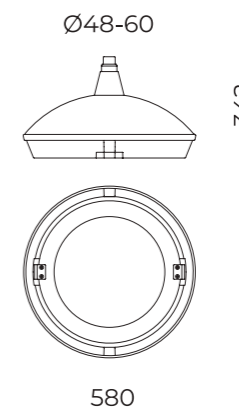

ACCESSORI / ACCESSORIES

01AK913CO
Kit di sospensione
per fune tesata Ø 6 ÷ 12 mm
Suspension kit for string Ø 6 ÷ 12 mm

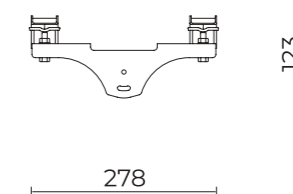

BIG LINK



L'ampia gamma di soluzioni ottiche e di fissaggio rendono BIG LINK una soluzione ideale per l'illuminazione di spazi e percorsi urbani in ogni città. Design by Silvio De Ponte.

The wide range of optical and installation solutions make BIG LINK an ideal solution for lighting urban spaces and pathways in every city. Design by Silvio De Ponte.



CityLife SHOPPING DISTRICT

220 240V	50 60Hz	CL II	IP66	IK08	ta -30°C +50°C
-------------	------------	-------	------	------	----------------------



DATI PRESTAZIONALI / PERFORMANCE DATA

Flusso apparecchio / Fitting flux:
3720 - 17140 lm

Potenza apparecchio / Fitting power:
26,5 - 128,5 W

Indice di resa cromatica / Colour Rendering Index:
CRI ≥ 70, SDCM ≤ 4

Illuminazione intelligente / Smart Lighting:
mezzanotte virtuale. Su richiesta DALI, CLO
virtual midnight. On request DALI, CLO

MATERIALI / MATERIALS

Corpo e sistemi di fissaggio / Body and fitting system:
pressofusione di lega d'alluminio UNI EN AB 47100
(contenuto rame < 1%) / die-cast aluminum alloy UNI EN
AB 47100 (copper content < 1%)

Copertura / Upper dome:
tornitura di lastra di alluminio
aluminium plate turning

Schermo / Screen:
vetro piano temprato / tempered flat glass

Gruppo ottico / Optical unit:
lenti PMMA ad alta trasparenza
high-transparency PMMA lenses

Finitura / Finish:
fosfocromatazione e verniciatura in polveri di poliestere
realizzata in 16 fasi per la miglior resistenza agli
agenti atmosferici / phospho-chromatation treated
and polyester powder-coated in 16 phases to increase
weather resistance

TEMPERATURA COLORE COLOUR TEMPERATURE

- 3000 K
- 4000 K

COLORI / COLOURS

- SABLÉ 100 NOIR



CARATTERISTICHE / FEATURES

Peso massimo / Max weight:
11 kg

Alimentazione elettronica / Electronic power supply:
inclusa / included

Resistenza sovratensioni / Surge Protection Device:
10 kV MC/MD

Precablaggio / Pre-wiring:
prodotto pre-cablato con cavo e connettore
pre-wired product with cable and connector

Installazione / Installation:
lato palo, sospensione braccio
pole side, arm suspension

ST-01 Narrow Street
L / H = 0,75

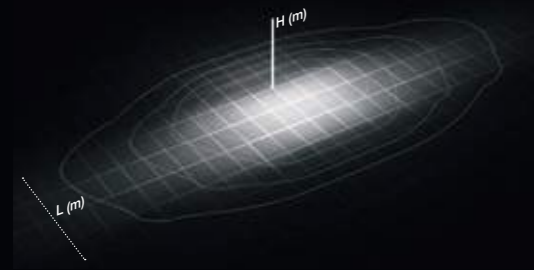

LA-01 Wide Street
L / H = 1,25

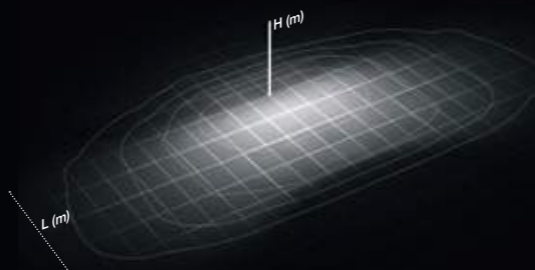

ME-01 Medium Street
L / H = 1

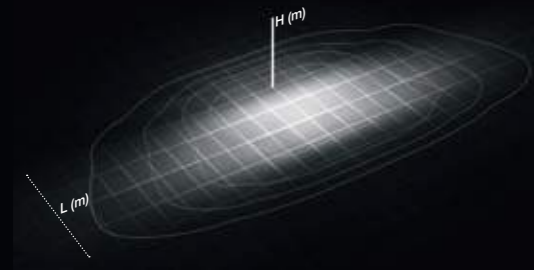

LT-06 Asymmetric Beam
L / H = 2

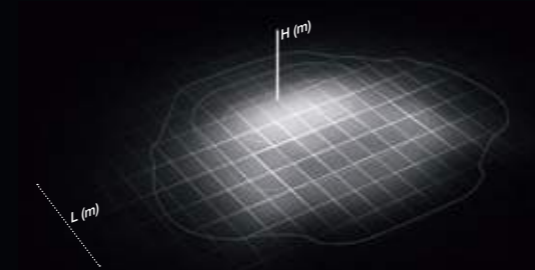

Big Link
Lato palo / Pole side

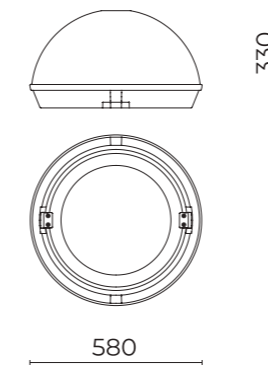

DATI TECNICI / TECHNICAL DATA

Installazione / Installation:

con accessori su bracci Ø 48 - 60 mm per pali Ø 60 - 76 - 102 - 114 mm.
Con accessorio 01AK902C0 su pali Ø 60 mm
with accessories on arms Ø 48 - 60 mm for poles Ø 60 - 76 - 102 - 114 mm.
With accessory 01AK902C0 on poles Ø 60 mm

ACCESSORI / ACCESSORIES

01AK901C0
L1 - Kit laterale fisso
per braccio
Fixed side kit for arm

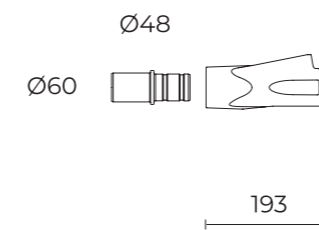

01AK902C0
L2 - Kit laterale regolabile
per palo o braccio
Adjustable side kit for pole or arm

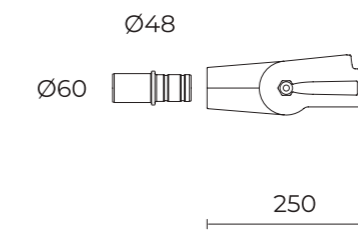

01AK903C0
L3 - Kit giunto
per palo o braccio
Joint kit for pole or arm

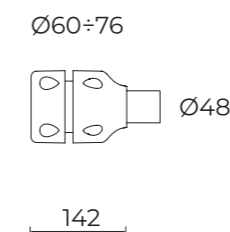

01AK904C0
L4 - Kit giunto doppio
per palo o braccio
Double joint kit for pole or arm

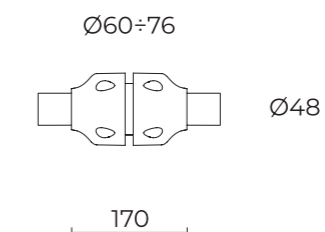

Big Link

Lato palo / Pole side

ACCESSORI E BRACCI / ACCESSORIES AND ARMS:

06AK905CO
B153 - Giunto testa palo H 90 mm
 Joint post top H 90 mm

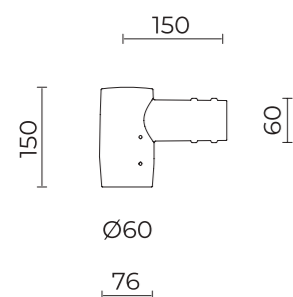

01SC904ADO
E1 - Kit esagono 1 - 2 agganci 180° per palo Ø 114 mm
 Hexagonal connector kit 1 - 2 180° couplings for a Ø 114 mm pole

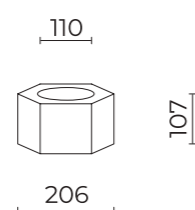

06AK906CO
B154 - Braccio per pali
 Arm for poles

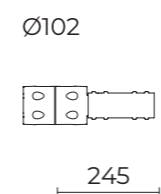

06AK908CO
B156 - Braccio doppio per pali
 Double arm for poles

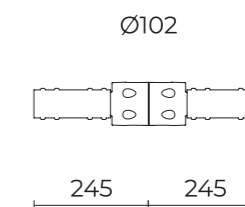

01AK921CO
B1 - Braccio per pali
 Arm for poles

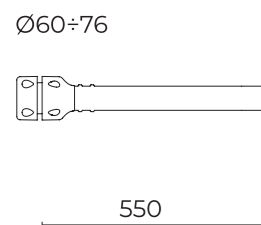

01AK922CO
B2 - Braccio doppio per pali
 Double arm for poles

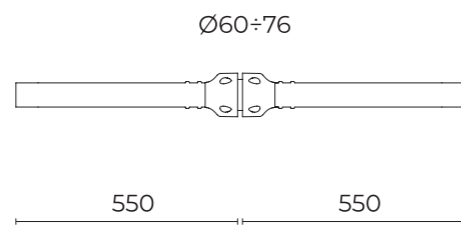

06AK907CO
B155 - Braccio per pali
 Arm for poles

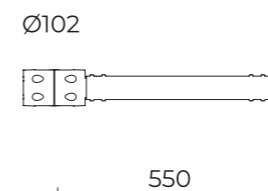

06AK909CO
B157 - Braccio doppio per pali
 Double arm for poles

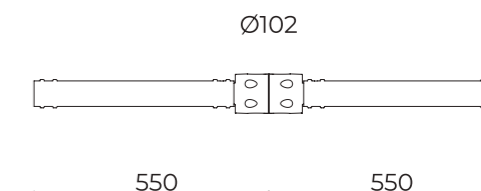

01AK923CO
B3 - Braccio con tirante per pali
 Arm with tensioning rod for poles

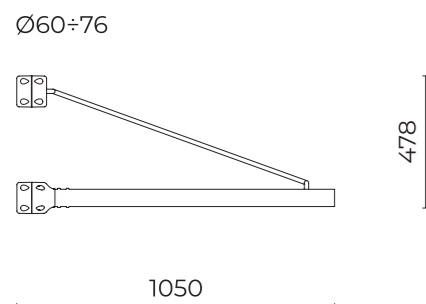

01AK924CO
B4 - Braccio doppio con tirante per pali
 Double arm with tensioning rod for poles

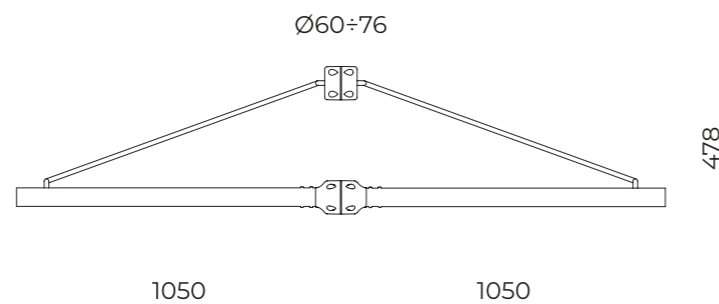

01AK931CO
B11 - Braccio lavorato per pali
 Arm machined for poles

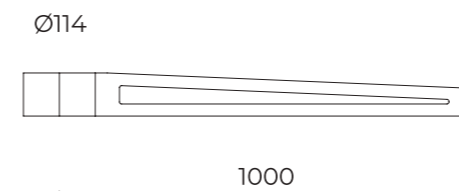

01AK951CO
B1-P - Braccio parete
 Arm for wall

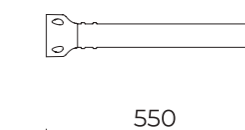

OTTICHE / OPTICS

ST-01 Narrow Street
L / H = 0,75

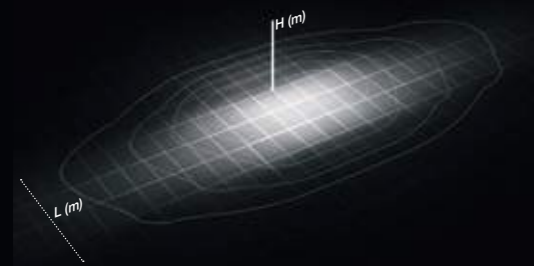

LA-01 Wide Street
L / H = 1,25

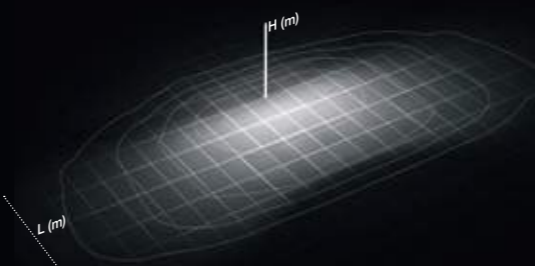

ME-01 Medium Street
L / H = 1

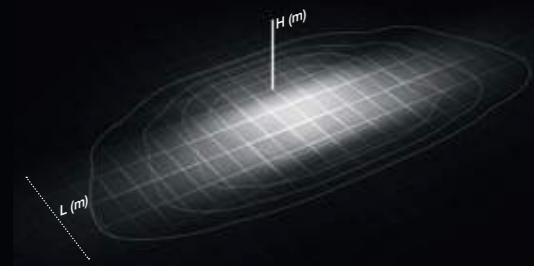

LT-06 Asymmetric Beam
L / H = 2

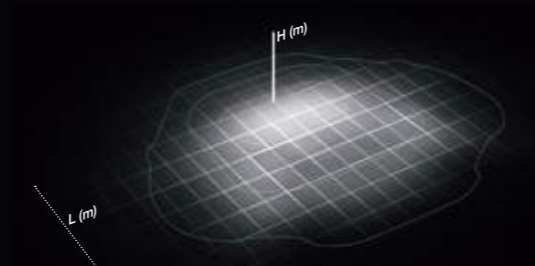

Big Link
Sospensione braccio / Arm suspension

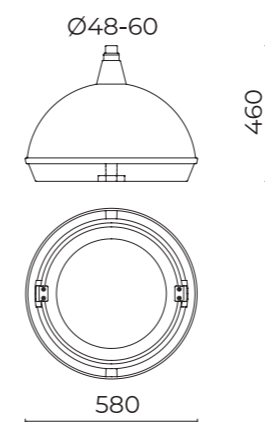

DATI TECNICI / TECHNICAL DATA

Installazione / Installation:
con accessori su bracci 1"1/2 GAS, 3/4" GAS; su bracci
Ø 48 - 60 mm per pali Ø 60 - 76 - 102 - 114 mm
with accessories on arms 1"1/2 GAS, 3/4" GAS; on arms
Ø 48 - 60 mm for poles Ø 60 - 76 - 102 - 114 mm

ACCESSORI / ACCESSORIES

01AK907C0
L16 - Kit sospensione maschio
Male suspension kit

1"1/2 GAS



Ø48

01AK914C0
L17 - Kit sospensione maschio
Male suspension kit

3/4" GAS

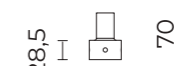

Ø48



Big Link

Sospensione braccio / Arm suspension

BRACCI / ARMS

01AK933C0
B13 - Braccio ad arco per pali
Arched arm for poles

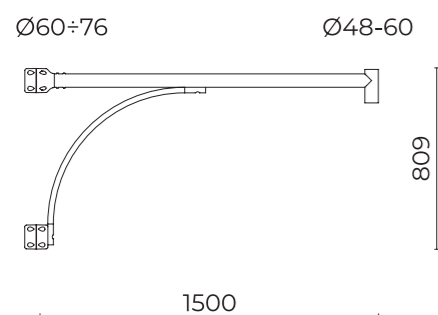

01AK934C0
B14 - Braccio ad arco doppio per pali
Double arched arm for poles

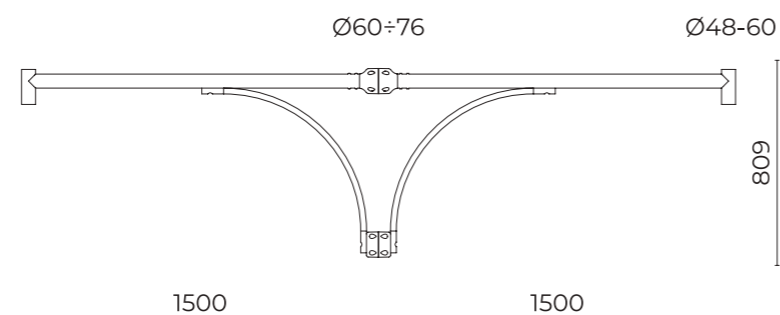

01AK935C0
B15 - Braccio pastorale per pali
Curved arm for poles

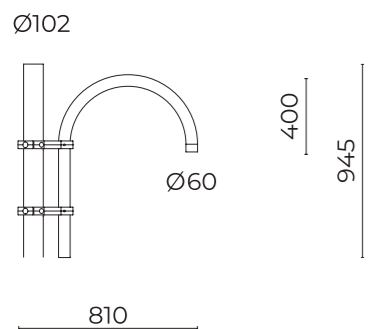

01AK936C0
B16 - Braccio pastorale doppio per pali
Double curved arm for poles

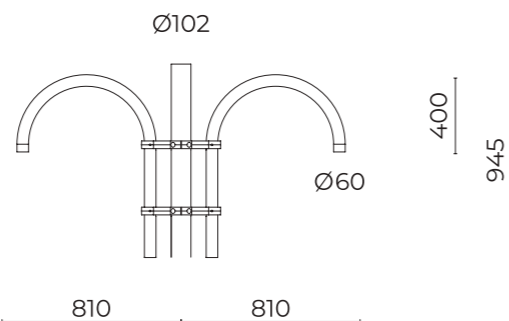

01AK950C0
B15-P - Braccio pastorale a parete
Curved arm for wall

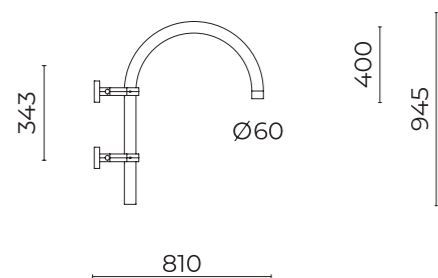

CLASSIC



CLASSIC coniuga forme tradizionali e innovazione tecnologica. È particolarmente adatto all'illuminazione di centri storici e di tutti i percorsi e gli spazi urbani con un lungo passato.

CLASSIC combines traditional shapes with technological innovation. It is particularly suitable for lighting historical centres and all the pathways and urban spaces with a long past.

220 240V	50 60Hz	CL II	IP66	IK08	ta -30°C +50°C
-------------	------------	-------	------	------	----------------------



DATI PRESTAZIONALI / PERFORMANCE DATA

Flusso apparecchio / Fitting flux:
1540 - 13840 lm

Potenza apparecchio / Fitting power:
26,5 - 103,5 W

Indice di resa cromatica / Colour Rendering Index:
CRI ≥ 70, SDCM ≤ 4

Illuminazione intelligente / Smart lighting:
mezzanotte virtuale. Su richiesta DALI, CLO, PLC,
telegestione wireless / virtual midnight. On request
DALI, CLO, PLC, wireless telemanagement

MATERIALI / MATERIALS

Corpo e sistemi di fissaggio / Body and fitting system:
pressofusione di lega d'alluminio UNI EN AB 47100
(contenuto rame < 1%) / die-cast aluminum alloy UNI EN
AB 47100 (copper content < 1%)

Copertura / Upper dome:
tornitura di lastra di alluminio
aluminium plate turning

Schermo / Screen:
vetro piano temprato / tempered flat glass

Gruppo ottico / Optical unit:
lenti PMMA ad alta trasparenza
high-transparency PMMA lenses

Finitura / Finish:
fosfocromatazione e verniciatura in polveri di poliestere
realizzata in 16 fasi per la miglior resistenza agli
agenti atmosferici / phospho-chromatation treated
and polyester powder-coated in 16 phases to increase
weather resistance

TEMPERATURA COLORE COLOUR TEMPERATURE

- 2200 K
- 3000 K
- 4000 K

COLORI / COLOURS

- SABLÉ 100 NOIR

CARATTERISTICHE / FEATURES

Peso massimo / Max weight:
11 kg

Alimentazione elettronica / Electronic power supply:
inclusa / included

Resistenza sovratensioni / Surge Protection Device:
10 kV MC/MD

Installazione / Installation:
sospensione braccio, parete / arm suspension, wall



ME-01 Medium Street
L / H = 1

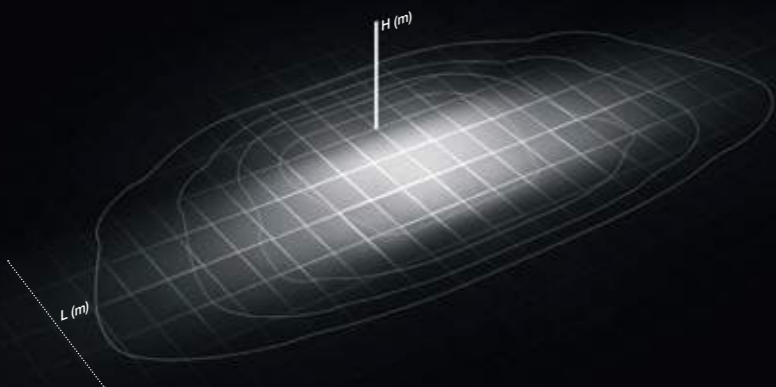

LA-01 Wide Street
L / H = 1,25

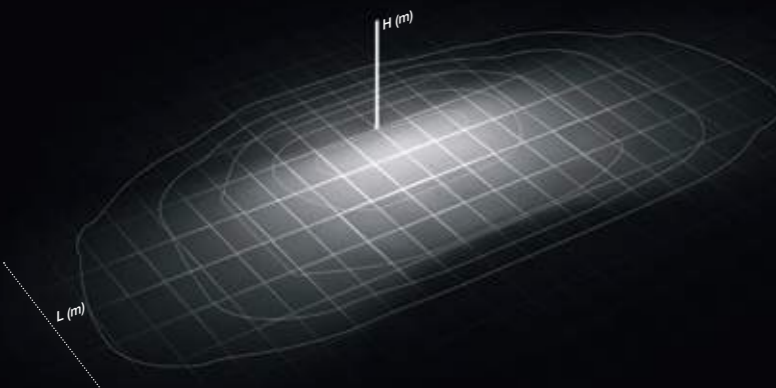

Sospensione braccio / Arm suspension

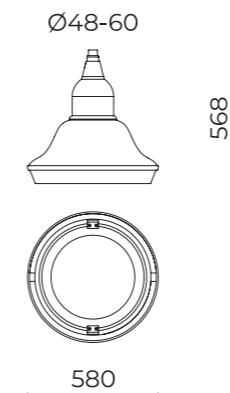

DATI TECNICI / TECHNICAL DATA

Installazione / Installation:
con accessori su bracci 1"1/2 GAS, 3/4" GAS; su bracci
Ø 48 - 60 mm per pali Ø 102 mm / with accessories on arms
1"1/2 GAS, 3/4" GAS; on arms Ø 48 - 60 mm for poles Ø 102 mm

ACCESSORI / ACCESSORIES

01AK907CO
L16 - Kit sospensione maschio
Male suspension kit

1"1/2 GAS



Ø48

01AK914CO
L17 - Kit sospensione maschio
Male suspension kit

3/4" GAS



Ø48

01AK935CO
B15 - Braccio pastorale per pali
Curved arm for poles

Ø102

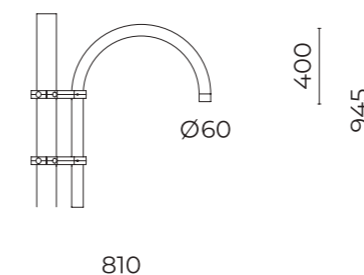

01AK936CO
B16 - Braccio pastorale doppio per pali
Double curved arm for poles

Ø102

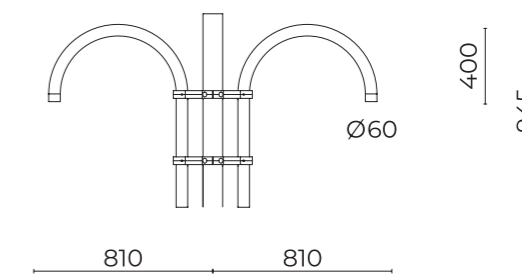

ME-01 Medium Street
L / H = 1



LA-01 Wide Street
L / H = 1,25



Classic
Parete / Wall

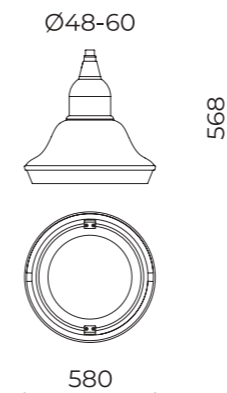

DATI TECNICI / TECHNICAL DATA

Installazione / Installations:
parete / wall-mounted

ACCESSORI / ACCESSORIES

01AK907CO
L16 - Kit sospensione maschio
Male suspension kit

1"½ GAS



Ø48

01AK914CO
L17 - Kit sospensione maschio
Male suspension kit

¾" GAS



Ø48

01AK950CO
B15-P - Braccio pastorale a parete
Curved arm for wall

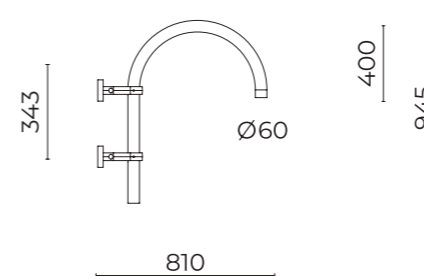

Classic

BUCHAREST
Romania



SAN FELICE CIRCEO
Italy



MÂT BALANCIER

MÂT BALANCIER è un originale sistema d'arredo urbano disegnato dall'architetto e lighting designer François Migeon.

MÂT BALANCIER is an original urban lighting system designed by the architect and lighting designer François Migeon.





220 240V	50 60Hz	CL II	IP66	IK06	ta -30°C +50°C
-------------	------------	-------	------	------	----------------------



DATI PRESTAZIONALI / PERFORMANCE DATA

Flusso apparecchio / Fitting flux:
1785 - 13230 lm

Potenza apparecchio / Fitting power:
13,5 - 103,5 W

Indice di resa cromatica / Colour Rendering Index:
CRI ≥ 70, SDCM ≤ 4

Illuminazione intelligente / Smart Lighting:
mezzanotte virtuale. Su richiesta ZHAGA, DALI, CLO, PLC,
telegestione wireless
virtual midnight. On request ZHAGA, DALI, CLO, PLC,
wireless telemanagement

MATERIALI / MATERIALS

Corpo e sistemi di fissaggio / Body and fitting system:
pressofusione di lega d'alluminio UNI EN AB 47100
(contenuto rame < 1%) / die-cast aluminum alloy UNI EN
AB 47100 (copper content < 1%)

Palo / Pole:
in acciaio a sezione circolare / round steel pole

Schermo / Screen:
vetro piano temprato / tempered flat glass

Gruppo ottico / Optical unit:
lenti PMMA ad alta trasparenza
high-transparency PMMA lenses

Finitura / Finish:
fosfocromatazione e verniciatura in polveri di poliestere
realizzata in 16 fasi per la miglior resistenza agli
agenti atmosferici / phospho-chromatation treated
and polyester powder-coated in 16 phases to increase
weather resistance

TEMPERATURA COLORE
COLOUR TEMPERATURE

- 3000 K
- 4000 K

COLORI / COLOURS

- SABLÉ 100 NOIR

CARATTERISTICHE / FEATURES

Peso massimo / Max weight:
140 kg

Alimentazione elettronica / Electronic power supply:
inclusa / included

Resistenza sovratensioni / Surge Protection Device:
10 kV MC/MD

Installazione / Installation:
lato palo / pole side



ST-01 Narrow Street
L / H = 0,75

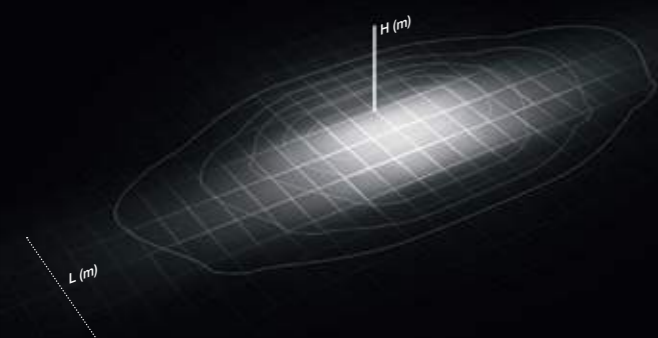

LA-01 Wide Street
L / H = 1,25

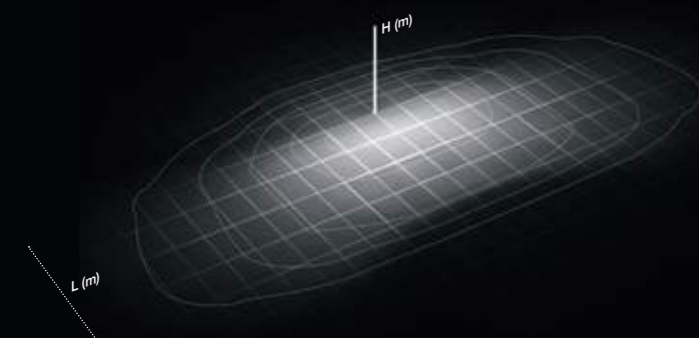

Mât Balancier
Lato palo / Pole side

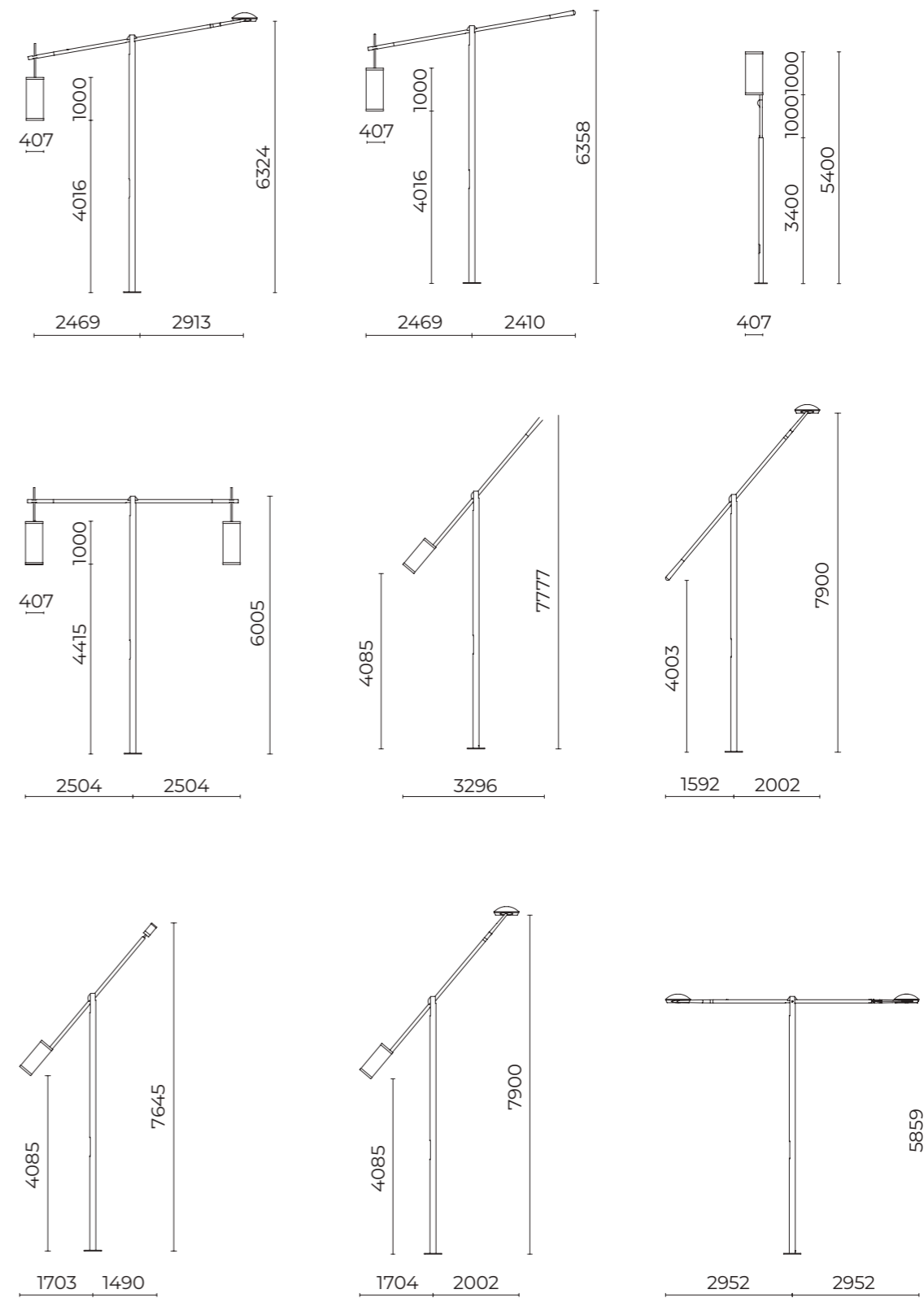

KOINÈ



Gamma di armature stradali particolarmente efficiente, adatta per l'illuminazione di grandi aree, percorsi pedonali, strade urbane ed extra-urbane.

Range of highly performing street lighting, suitable for lighting of wide area, pathways, urban and extra-urban streets.

220 240V	50 60Hz	CL II	IP66	IK09	ta -30°C +50°C
-------------	------------	-------	------	------	----------------------



DATI PRESTAZIONALI / PERFORMANCE DATA

Flusso apparecchio / Fitting flux:
1355 (1800 K) - 23180 lm

Potenza apparecchio / Fitting power:
12 - 155 W

Indice di resa cromatica / Colour Rendering Index:
CRI ≥ 70, SDCM ≤ 3

Illuminazione intelligente / Smart lighting:
mezzanotte virtuale, ZHAGA. Su richiesta DALI, CLO,
telegestione wireless / virtual midnight and ZHAGA. On
request DALI, CLO, wireless telemanagement

MATERIALI / MATERIALS

Corpo e codolo / Body and fastening part:
pressofusione di lega d'alluminio UNI EN AB 47100
(contenuto rame < 1%) / die-cast aluminum alloy UNI EN
AB 47100 (copper content < 1%)

Schermo / Screen:
vetro piano temprato / tempered flat glass

Gruppo ottico / Optical unit:
lenti PMMA ad alta trasparenza
high-transparency PMMA lenses

Finitura / Finish:
fosfocromatazione e verniciatura in polveri di poliestere
realizzata in 16 fasi per la miglior resistenza agli
agenti atmosferici / phospho-chromatation treated
and polyester powder-coated in 16 phases to increase
weather resistance

TEMPERATURA COLORE COLOUR TEMPERATURE

- 2700 K
- 3000 K
- 4000 K

ECO-CENTRIC LIGHTING (ECL)

(ONLY FOR STREET OPTICS)

BLUE FREE LIGHT:
PC-AMBER 0,7% $\sum R$ ($\lambda < 500\text{NM}$) – CRI 40
1800 K 4,3% $\sum R$ ($\lambda < 500\text{NM}$) – CRI 70

SWITCHABLE WHITE LIGHT:
1800K / 3000K

COLORI / COLOURS

- RAL9006



CARATTERISTICHE / FEATURES

Peso massimo / Max weight:
3.2 kg (x-small), 4.2 (small), 6.2 kg (medium)

Alimentazione elettronica / Electronic power supply:
inclusa / included

Resistenza sovratensioni / Surge Protection Device:
10 kV MC/MD

Accesso vano cablaggio / Wiring compartment opening:
senza utensili / without tools

Installazione / Installation:
palo, braccio / pole, arm

OTTICHE / OPTICS

LT-C1 Cycle Path
L / H = 0,5

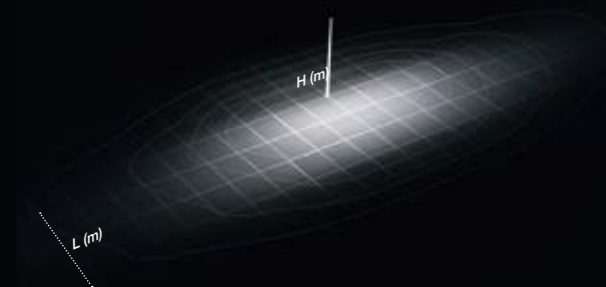

PB-01 Low Pole
L / H = 2

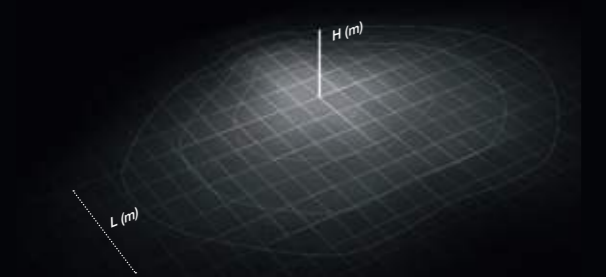

LT-63 Asymmetric Beam
L / H = 2

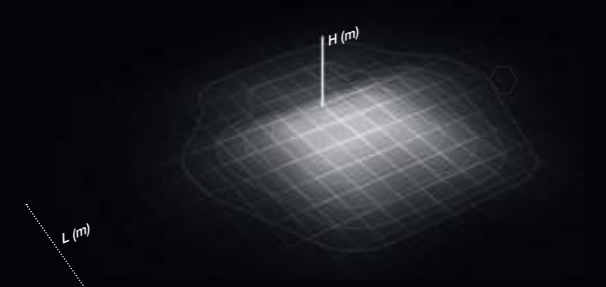

LT-64 Asymmetric Beam with backlight
L/H = 2

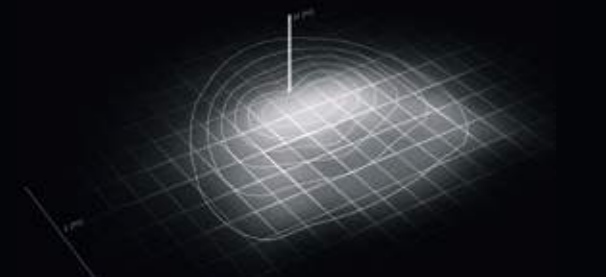

ST-02 Narrow Street
L / H = 0,75

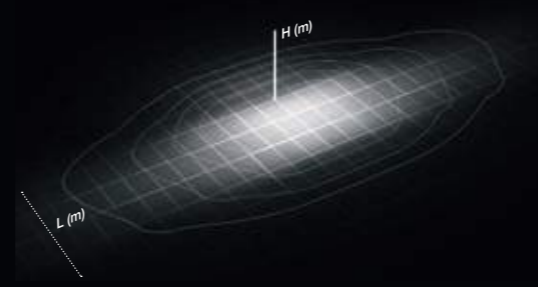

ME-05 Medium Street
L / H = 1

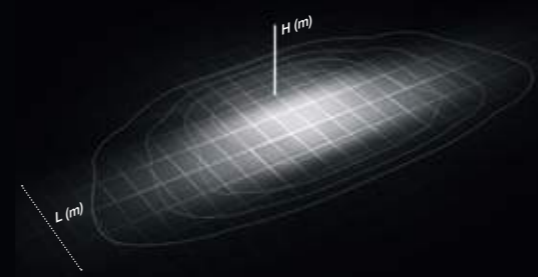

LA-03 Wide Street
L / H = 1,25

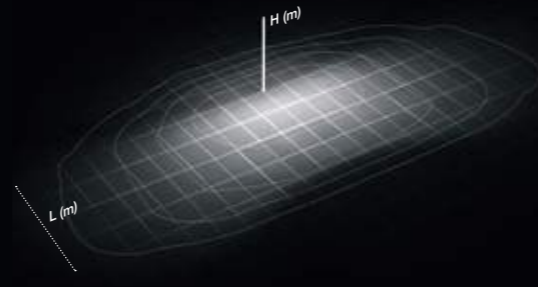

Koinè
Palo / Pole

DATI TECNICI / TECHNICAL DATA

Installazione / Installation:
pali Ø 46 - 60 - 76 mm
poles Ø 46 - 60 - 76 mm

Inclinazione / Inclination:
0° ÷ 90° (con passo 5°)
0° ÷ 90° (step 5°)

X-SMALL

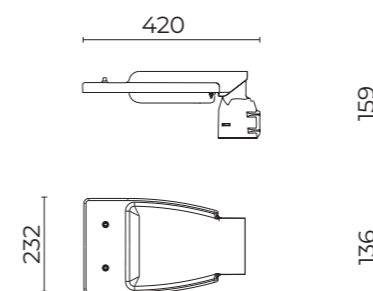

SMALL

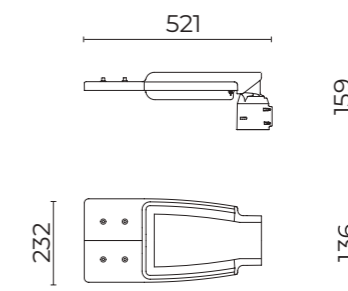

MEDIUM

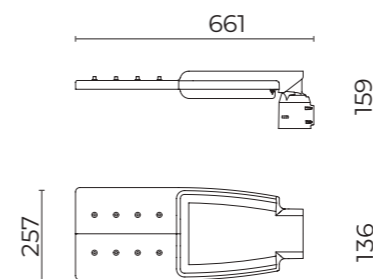

OTTICHE / OPTICS

LT-C1 Cycle Path
L / H = 0,5

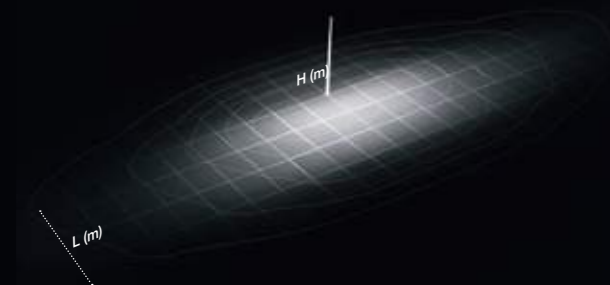

ST-02 Narrow Street
L / H = 0,75

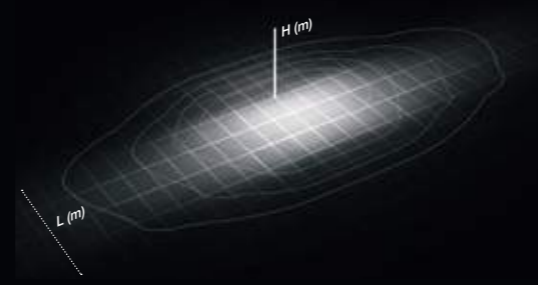

ECL

PB-01 Low Pole
L / H = 2

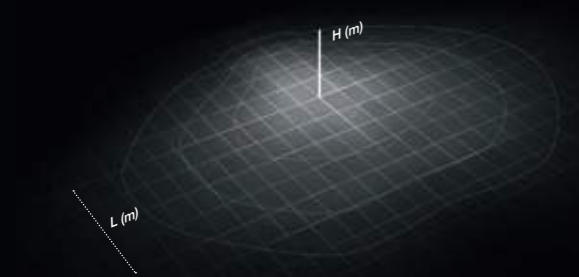

ME-05 Medium Street
L / H = 1

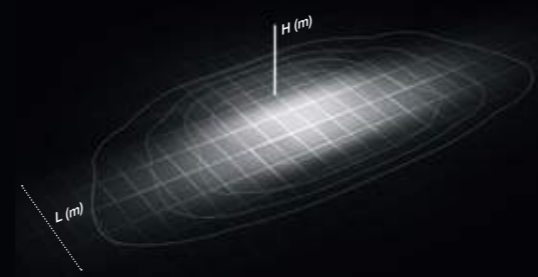

ECL

LT-63 Asymmetric Beam
L / H = 2

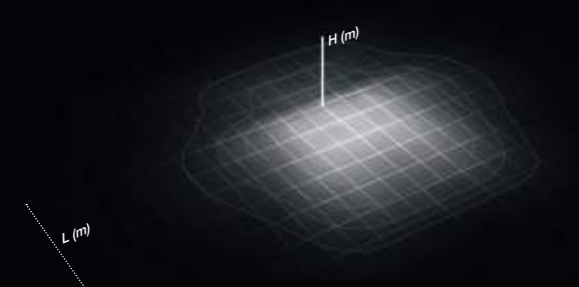

LA-03 Wide Street
L / H = 1,25

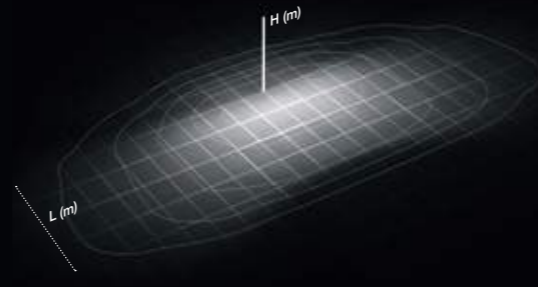

ECL

LT-64 Asymmetric Beam with backlight
L/H = 2

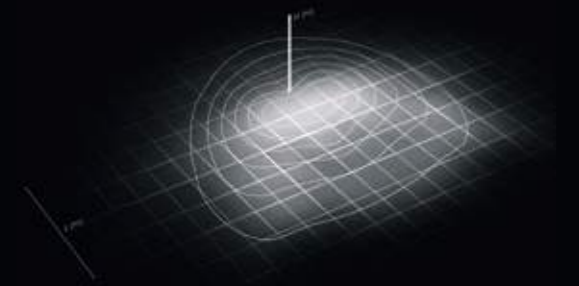

ECL

Koinè

Braccio - Parete / Arm - Wall

DATI TECNICI / TECHNICAL DATA

Installazione / Installation:
bracci Ø 46 - 60 - 76 mm
arms Ø 46 - 60 - 76 mm

Inclinazione / Inclination:
0° ÷ -90° (con passo 5°)
0° ÷ -90° (step 5°)

X-SMALL

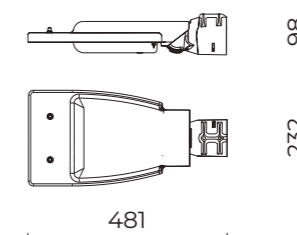

SMALL

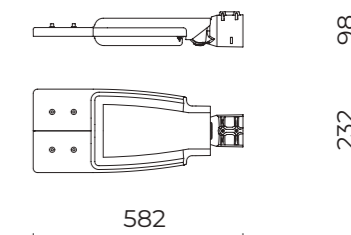

MEDIUM

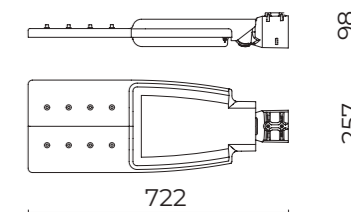

BRACCI / ARMS

01AK921A0 - RAL9006
B1 - Braccio per pali
Arm for poles

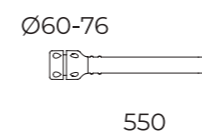

01AK922A0 - RAL9006
B2 - Braccio doppio per pali
Double arm for poles

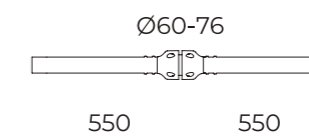

01AK951A0 - RAL9006
B1-P - Braccio parete
Arm for wall

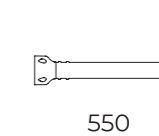

01AK969A0 - RAL9006
B74 - Braccio con tirante per pali
Arm with tensioning rod for poles

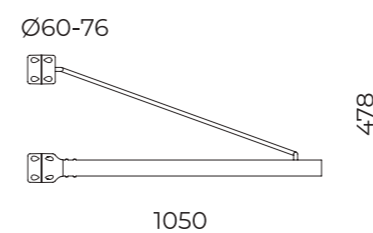

01AK968A0 - RAL9006
B59 - Braccio doppio con tirante per pali
Double arm with tensioning rod for poles

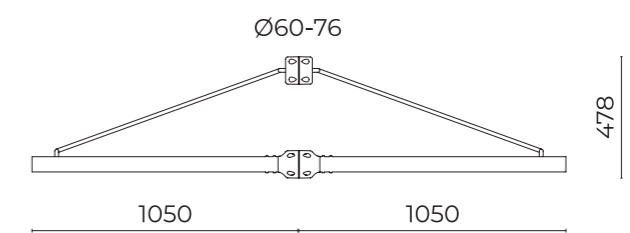

KAI

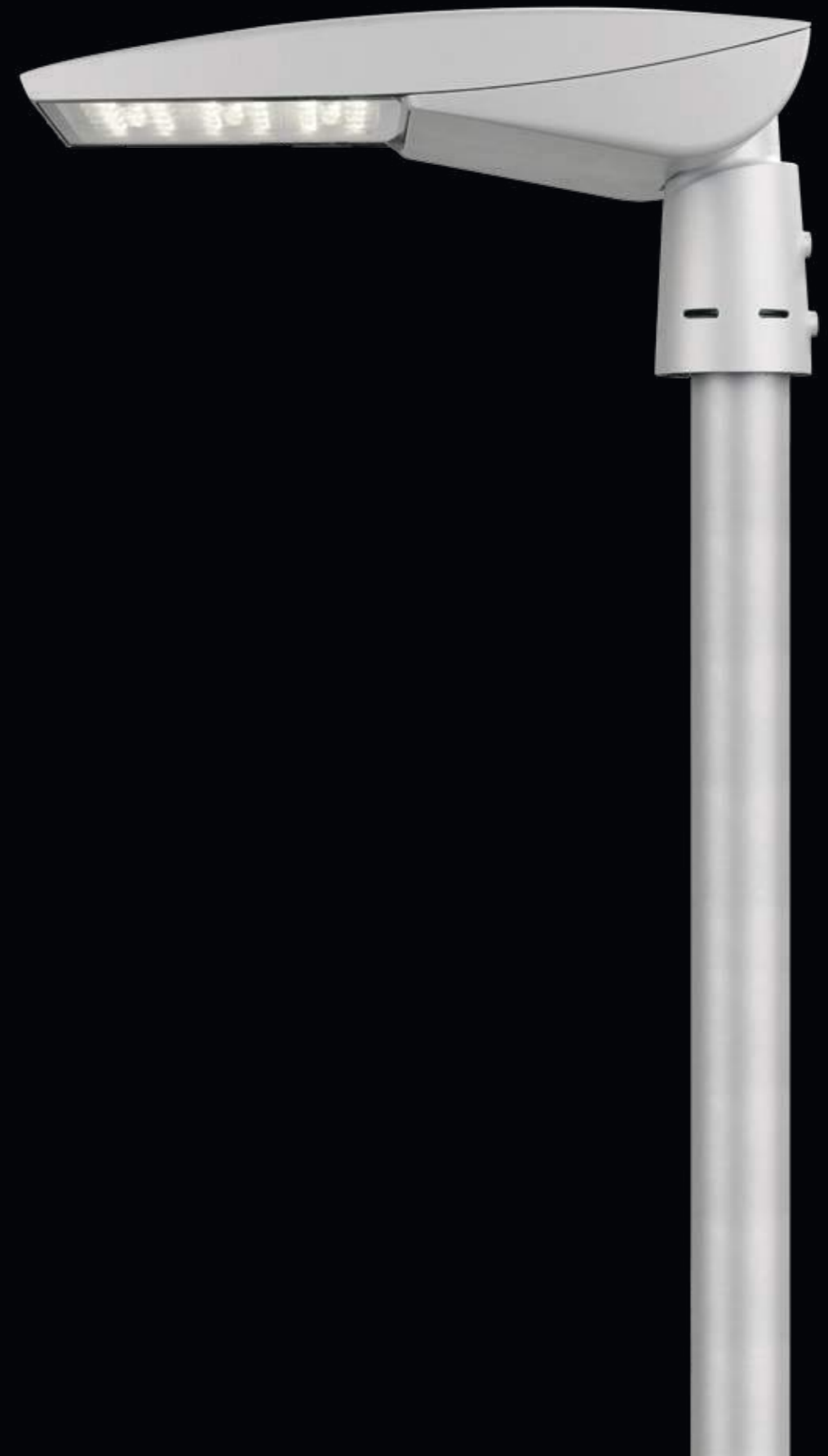

Gamma di armature stradali altamente performante sia in termini di qualità della distribuzione luminosa che di efficienza energetica.

Range of highly performing street lighting both in terms of quality of light distribution and energy efficiency.

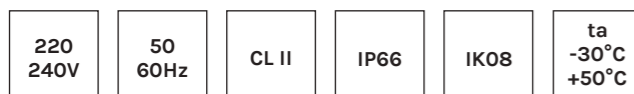

DATI PRESTAZIONALI / PERFORMANCE DATA

Flusso apparecchio / Fitting flux:
1885 - 20830 lm

Potenza apparecchio / Fitting power:
13,5 - 154 W

Indice di resa cromatica / Colour Rendering Index:
CRI ≥ 70, SDCM ≤ 4

Illuminazione intelligente / Smart lighting:
mezzanotte virtuale. Su richiesta ZHAGA, DALI, CLO, PLC,
telegestione wireless / virtual midnight. On request
ZHAGA, DALI, CLO, PLC, wireless telemanagement

MATERIALI / MATERIALS

Corpo e codolo / Body and fastening part:
pressofusione di lega d'alluminio UNI EN AB 47100
(contenuto rame < 1%) / die-cast aluminum alloy UNI EN
AB 47100 (copper content < 1%)

Schermo / Screen:
vetro piano temprato / tempered flat glass

Gruppo ottico / Optical unit:
lenti PMMA ad alta trasparenza
high-transparency PMMA lenses

Finitura / Finish:
fosfocromatazione e verniciatura in polveri di poliestere
realizzata in 16 fasi per la miglior resistenza agli
agenti atmosferici / phospho-chromatation treated
and polyester powder-coated in 16 phases to increase
weather resistance

TEMPERATURA COLORE COLOUR TEMPERATURE

- 2200 K
- 3000 K
- 4000 K

COLORI / COLOURS

- RAL9006



CARATTERISTICHE / FEATURES

Peso massimo / Max weight:
6,5 kg (small), 7,5 kg (small x), 11 kg (medium)

Alimentazione elettronica / Electronic power supply:
inclusa / included

Resistenza sovratensioni / Surge Protection Device:
10 kV MC/MD

Apertura vano cablaggio / Wiring compartment opening:
senza utensili / without tools

Installazione / Installation:
palo, braccio / pole, arm



OTTICHE / OPTICS

ST-01 Narrow Street
 $L / H = 0,75$

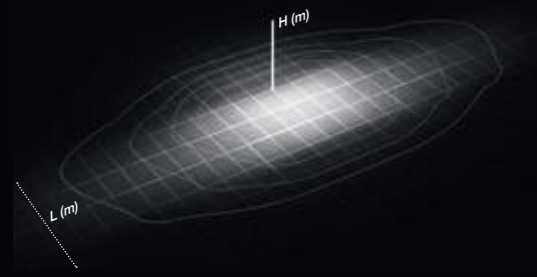

LA-01 Wide Street
 $L / H = 1,25$

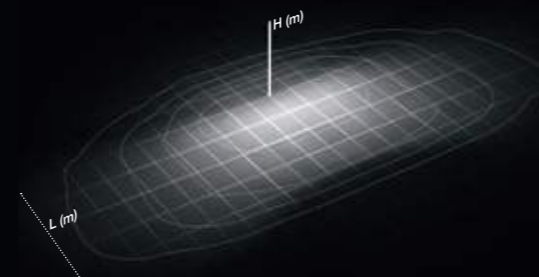

AP-01 DX Pedestrian Crossing

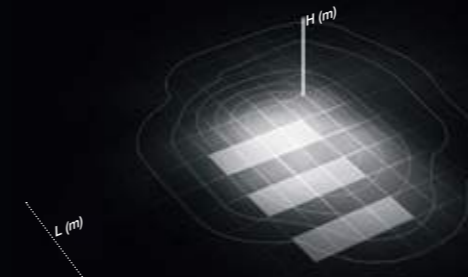

ME-01 Medium Street
 $L / H = 1$

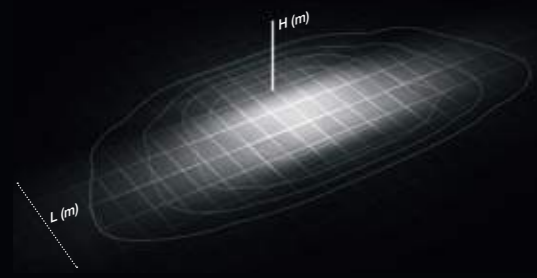

LT-05 Asymmetric Beam
 $L / H = 1,5$

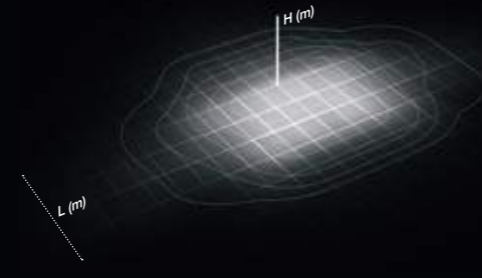

AP-01 SX Pedestrian Crossing

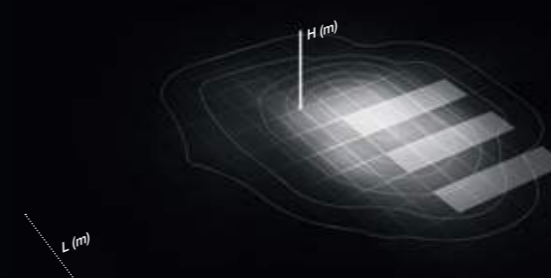

ME-02 Medium Street
 $L / H = 1,1$

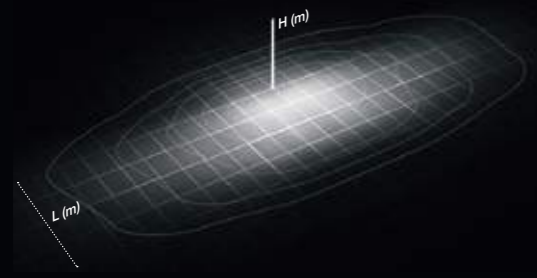

LT-06 Asymmetric Beam
 $L / H = 2$

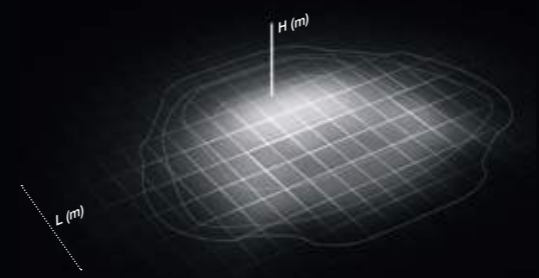

MB-01 Wet Road

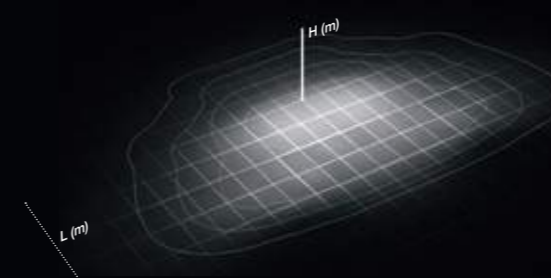

Kai

Palo / Pole

DATI TECNICI / TECHNICAL DATA

Installazione / Installation:
pali Ø 46 - 60 - 76 mm
poles Ø 46 - 60 - 76 mm

Inclinazione / Inclination:
0° ÷ 20° (con passo 5°)
0° ÷ 20° (step 5°)

SMALL

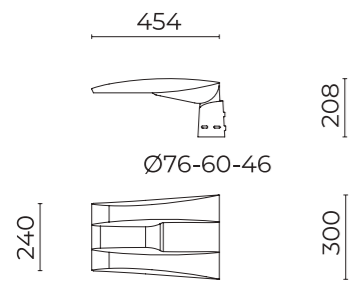

SMALL X

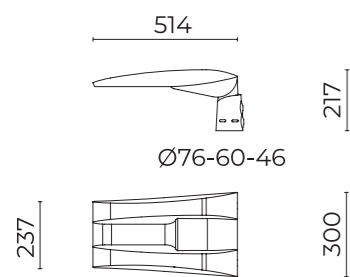

MEDIUM

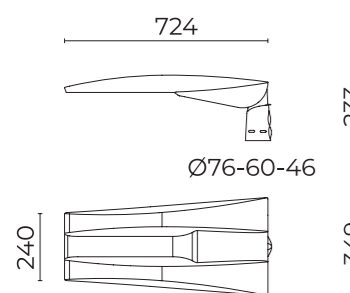

Kai

Braccio, Parete / Arm, Wall

DATI TECNICI / TECHNICAL DATA

Installazione / Installation:
bracci Ø 46 - 60 - 76 mm
arms Ø 46 - 60 - 76 mm

Inclinazione / Inclination:
0° ÷ -20° (con passo 5°)
0° ÷ -20° (step 5°)

SMALL

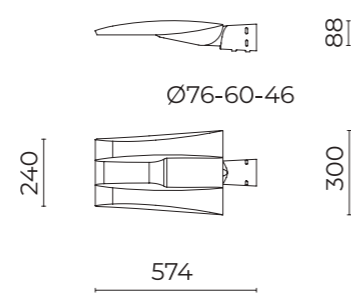

SMALL X

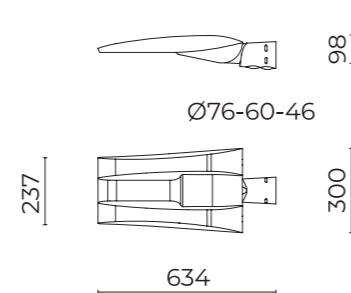

MEDIUM

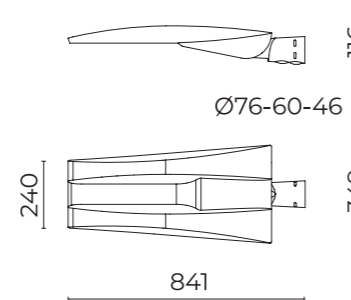

Kai

Braccio, Parete / Arm, Wall

BRACCI / ARMS

01AK921A0 - RAL 9006
B1 - Braccio per pali
Arm for poles

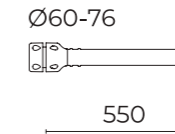

01AK922A0 - RAL 9006
B2 - Braccio doppio per pali
Double arm for poles

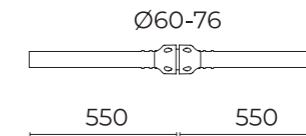

01AK969A0 - RAL 9006
B74 - Braccio con tirante per pali
Arm with tensioning rod for poles

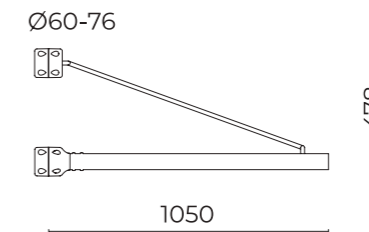

01AK968A0 - RAL 9006
B59 - Braccio doppio con tirante per pali / Double arm with tensioning rod for poles

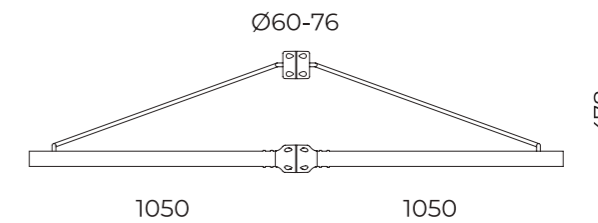

01AK951A0 - RAL 9006
B1-P - Braccio parete
Arm for wall

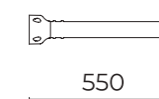

KAIROS



Gamma di armature stradali particolarmente performanti, adatta per l'illuminazione di spazi, percorsi urbani ed extra urbani.

Range of highly performing street lighting, suitable for lighting of spaces, urban and extra-urban streets.

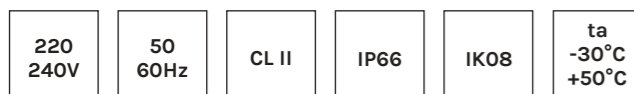

DATI PRESTAZIONALI / PERFORMANCE DATA

Flusso apparecchio / Fitting flux:
1520 - 29000 lm

Potenza apparecchio / Fitting power:
12 - 210 W

Indice di resa cromatica / Colour Rendering Index:
CRI ≥ 70, SDCM ≤ 3

Illuminazione intelligente / Smart lighting:
mezzanotte virtuale. Su richiesta ZHAGA, DALI, CLO, PLC,
telegestione wireless / virtual midnight. On request
ZHAGA, DALI, CLO, PLC, wireless telemanagement

TEMPERATURA COLORE COLOUR TEMPERATURE

- 2700 K
- 3000 K
- 4000 K

MATERIALI / MATERIALS

Corpo e codolo / Body and fastening part:
pressofusione di lega d'alluminio UNI EN AB 47100
(contenuto rame < 1%) / die-cast aluminum alloy UNI EN
AB 47100 (copper content < 1%)

Schermo / Screen:
vetro piano temprato / tempered flat glass

Gruppo ottico / Optical unit:
lenti PMMA ad alta trasparenza
high-transparency PMMA lenses

Finitura / Finish:
fosfocromatazione e verniciatura in polveri di poliestere
realizzata in 16 fasi per la miglior resistenza agli
agenti atmosferici / phospho-chromatation treated
and polyester powder-coated in 16 phases to increase
weather resistance

COLORI / COLOURS

- RAL9006



CARATTERISTICHE / FEATURES

Peso massimo / Max weight:
6,5 kg (small), 8,5 kg (medium)

Alimentazione elettronica / Electronic power supply:
inclusa / included

Resistenza sovratensioni / Surge Protection Device:
10 kV MC/MD

Installazione / Installation:
palo, braccio / pole, arm



ST-02 Narrow Street
L / H = 0,75

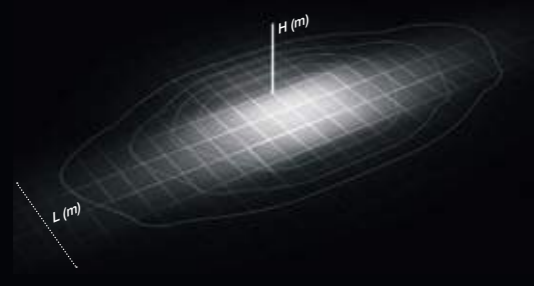

LA-03 Wide Street
L / H = 1,25

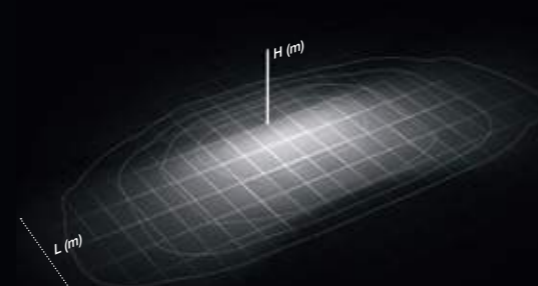

ME-05 Medium Street
L / H = 1

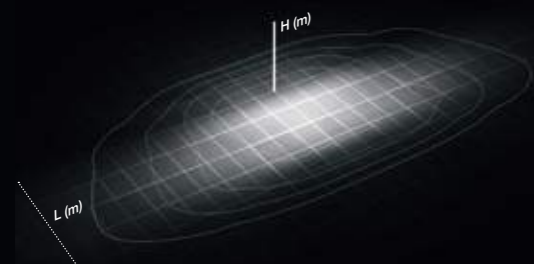

LT-64 Asymmetric Beam with backlight
L/H = 2



Kairos

Palo - Braccio / Pole - Arm

DATI TECNICI / TECHNICAL DATA

Installazione / Installation:
pali Ø 46 - 60 - 76 mm
poles Ø 46 - 60 - 76 mm

Inclinazione / Inclination:
0° + 20° (con passo 5°)
0° + 20° (step 5°)

SMALL

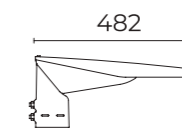

Ø46-60-76

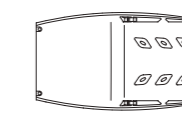

MEDIUM

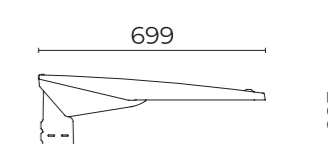

Ø46-60-76

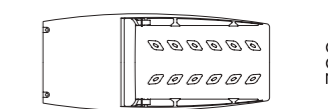

Braccio Parete / Arm wall

Inclinazione / Inclination:
0° + 20° (con passo 5°)
0° + 20° (step 5°)

SMALL

Ø46-60-76

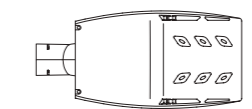

MEDIUM

Ø46-60-76

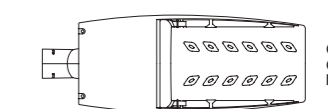

BRACCI / ARMS

01AK921AO - RAL9006
B1 - Braccio per pali
Arm for poles

Ø60-76

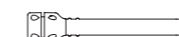

550

01AK922AO - RAL9006
B2 - Braccio doppio per pali
Double arm for poles

Ø60-76

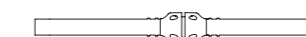

550 550

01AK951AO - RAL9006
B1-P - Braccio parete
Arm for wall



550

NEWTON 2.0



NEWTON 2.0 é una gamma completa di proiettori altamente performanti. Disponibile in quattro taglie x-small, small, medium e large, il sistema offre un range di flussi ed una combinazione di ottiche che lo rende adatto per l'illuminazione di impianti sportivi, grandi aree esterne ed aree perimetrali.

NEWTON 2.0 is a complete range of high-performance floodlights. Available in four sizes x-small, small, medium e large, the system offers a range of fluxes and a combination of optics that makes it suitable for lighting sports facilities, large outdoor areas and perimeter areas.



MILAN
Italy

Cariboni Group

GENOA
Italy



220-240V	50 60Hz	CL II	CL I*	IP66	IK09	ta -30°C +50°C
----------	------------	-------	-------	------	------	----------------------



(*) Le versioni large alla massima potenza sono disponibili in CL I

Large versions at maximum power are in CL I

DATI PRESTAZIONALI / PERFORMANCE DATA

Flusso apparecchio / Fitting flux:

1670 - 64050 lm

Potenza apparecchio / Fitting power:

12 - 498 W

Indice di resa cromatica / Colour Rendering Index:

≥ 70, SDCM ≤ 3

Illuminazione intelligente / Smart lighting:

mezzanotte virtuale, DALI e opzione emergenza (standard nella versione large). Su richiesta DALI (versioni x-small, small e medium), ZHAGA, CLO / virtual midnight, DALI and emergency options (standard large version). On request DALI (x-small, small e medium versions), ZHAGA, CLO

MATERIALI / MATERIALS

Corpo e sistemi di fissaggio / Body and fitting system:

pressofusione di lega d'alluminio UNI EN AB 47100 (contenuto rame < 1%) / die-cast aluminium alloy UNI EN AB 47100 (copper content < 1%)

Schermo / Screen:

vetro piano temprato / tempered flat glass

Gruppo ottico / Optical unit:

lenti PMMA ad alta trasparenza
PMMA high transparent lenses

Finitura / Finish:

fosfocromatazione e verniciatura in polveri di poliestere realizzata in 16 fasi per la miglior resistenza agli agenti atmosferici / phospho-chromatation treated and polyester powder-coated in 16 phases to increase weather resistance

Sistema di fissaggio / Fastening system:

staffa orientabile in acciaio verniciato (x-small, small, medium), staffa in acciaio INOX AISI 304 (large) / painted steel adjustable bracket (x-small, small, medium), stainless steel AISI 304 bracket (large)

TEMPERATURA COLORE COLOUR TEMPERATURE

● 3000 K

○ 4000 K

COLORE / COLOUR

● RAL9006



CARATTERISTICHE / FEATURES

Peso massimo / Max weight:

4 kg (x-small), 6,8 kg (small), 9,8 kg (medium), 14 kg (large)

Alimentazione elettronica / Electronic power supply:

inclusa, disponibili versioni large con cablaggio remoto included, available large version with remote driver

Predisposizione valvola GORE® nelle versioni large per regolare la

pressione interna in ambienti ostili / Predisposition to GORE® valve in large versions to regulate internal pressure in hostile environments

Installazione / Installation:

parete, soffitto, palo / wall, ceiling, pole
predisposizione entra-esci / predisposition IN-OUT

Orientabilità / Adjustability:

-90° ÷ +90° in regolazione continua / -90° ÷ +90° continuously

Resistenza alle pallonate / Safety against ball throwing:

le varianti Newton 2.0 medium e large hanno superato il test di resistenza alle pallonate secondo la Norma DIN 18032-3 / the Newton 2.0 medium and large variants have passed the ball throwing test according to DIN 18032-3



LA-03 Wide street
L / H = 1,25

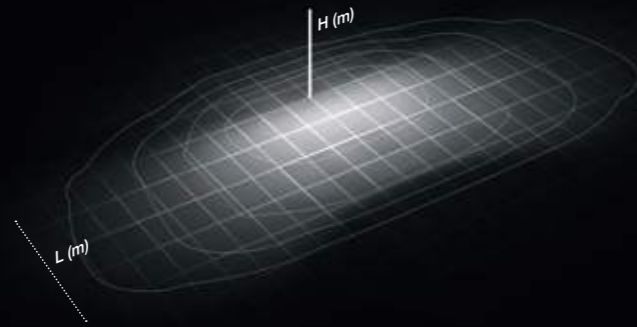

LT-63 Asymmetric beam
L / H = 2

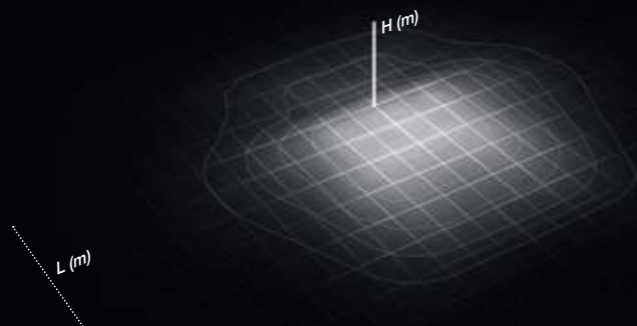

LT-64 Asymmetric beam with backlight
L / H = 2

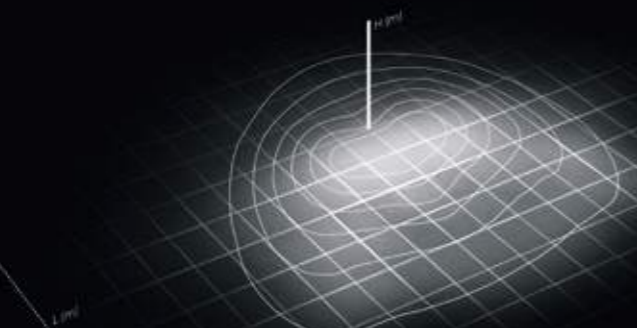

Newton 2.0

Newton 2.0
x-small



Newton 2.0
small



Newton 2.0
medium



Newton 2.0
large



Newton 2.0

parete, soffitto, palo / wall, ceiling, pole



XSMALL

SMALL

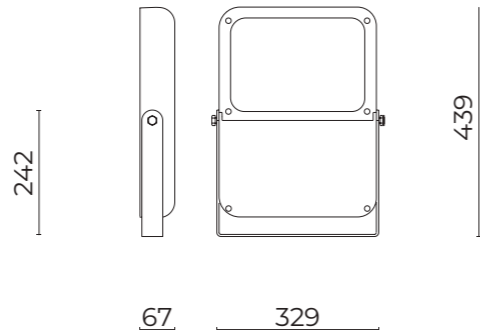
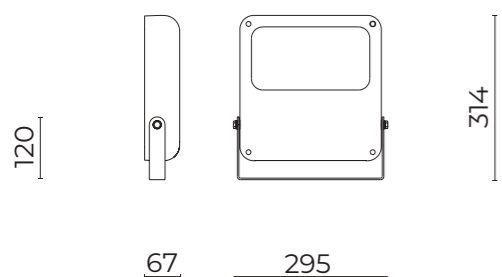

Newton 2.0

parete, soffitto, palo / wall, ceiling, pole



MEDIUM

LARGE

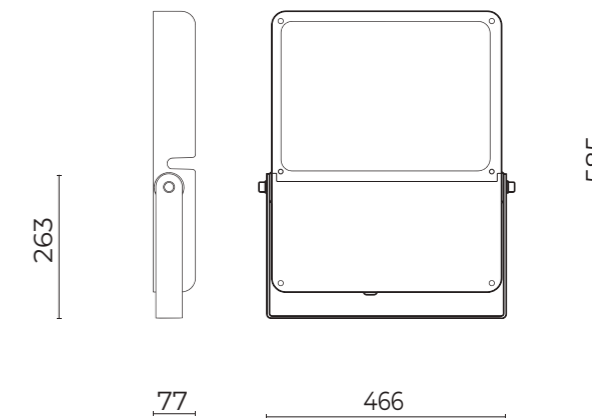
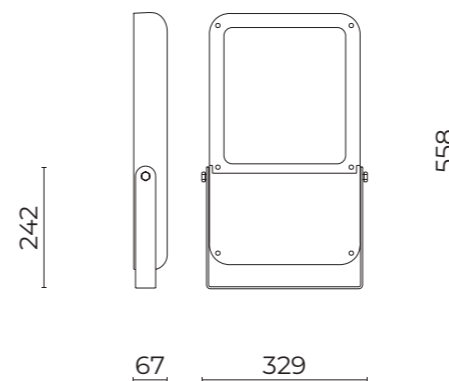

DATI TECNICI / TECHNICAL DATA

Installazione / Installation:
parete, soffitto, palo / wall, ceiling, pole

Orientabilità / Orientability:
staffa orientabile in regolazione continua -90° + 90°
continuously adjustable bracket -90° + 90°

ACCESSORI / ACCESSORIES

06NW902C0
L14 - Kit testa palo per pali
Post top kit for poles
(Newton 2.0 small e medium)

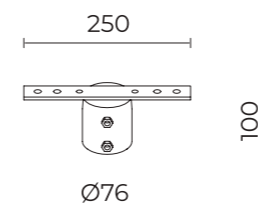



I dati qui pubblicati non sono impegnativi.
Cariboni Group, in favore di un costante
miglioramento dei propri prodotti, si
riserva di apportare senza preavviso le
opportune modifiche.

The data published here are not binding.
Cariboni Group, in favor of a constant
improvement of its products, reserves the
right to make changes without notice.

Metalmek Lighting B.V

Canadabaan7-d
5388 RT Nistelrode
Tel. 0412-614033

info@metalmek.nl
www.metalmek.nl

Metalmek

Cariboni
group

 **LIVAL**

NORDIC  **ALUMINIUM**