

TRAIL

Quaderno tecnico
Technical handbook

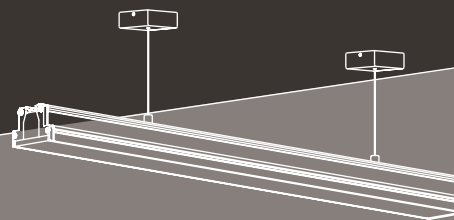
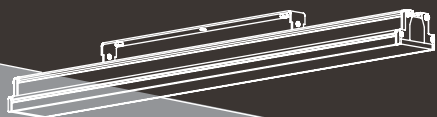

CARIBONI LITE S.R.L.

Via della Tecnica, 19
23875 Osnago (Lc)
Tel +39 039 95211
Fax +39 039 587812
carill@carill.com
www.caribonilite.com

cariboni
lite

TRAIL

TRAIL: le versioni *available versions*



Prodotto lineare a led per installazione ad incasso (parete e pavimento), a parete, a sospensione e a plafone.

Trail is a linear LED fitting suitable for recessed installation (wall and ground recessed), for wall-mounted installation, for pendant installation and for ceiling-mounted installation.

Corpo in estruso di alluminio anodizzato e vetro piano trasparente 6mm.

The body is made of extruded anodized aluminium, flat transparent glass, 6 mm thick.

2 taglie : 650 mm e 1250 mm.

2 sizes: 650 mm and 1250 mm.

Caratteristiche Tecniche

Alimentazione : 24Vdc +/- 5%

Classe di isolamento: CL.III

IP: 67

LED: MedPowerLED 3000K, 4000K 128lm/W

Flusso: 900lm-1800lm-3600lm

Potenza: 9W-19W-37W

Installazione: incasso pavimento e parete
a parete
a plafone e a sospensione

Technical features

Power supply: 24Vdc +/- 5%

Isolation class: CL.III

IP: 67

LED: MedPower LEDs 3000K, 4000K 128lm/W









Flux: 900lm-1800lm-3600lm

Nominal Power: 9W-19W-37W

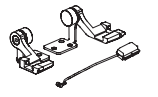
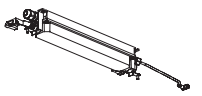
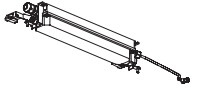
Installation: ground and wall recessed
Wall-mounted
Ceiling-mounted and pendant

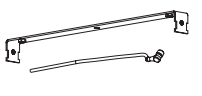
TRAIL 650				
S (900lm)	3000K	9W	Asimmetrica <i>Asymmetrical</i>	06TR2D6397J
		9W	Simmetrica <i>Symmetrical</i>	06TR2D6395J
		9W	Diffondente <i>Wide beam</i>	06TR2D6393J
	4000K	9W	Asimmetrica <i>Asymmetrical</i>	06TR2D6307J
		9W	Simmetrica <i>Symmetrical</i>	06TR2D2305J
		9W	Diffondente <i>Wide beam</i>	06TR2D6303J
H (1800lm)	3000K	19W	Asimmetrica <i>Asymmetrical</i>	06TR2H2397J
		19W	Simmetrica <i>Symmetrical</i>	06TR2H2395J
		19W	Diffondente <i>Wide beam</i>	06TR2H2393J
	4000K	19W	Asimmetrica <i>Asymmetrical</i>	06TR2H2307J
		19W	Simmetrica <i>Symmetrical</i>	06TR2H2305J
		19W	Diffondente <i>Wide beam</i>	06TR2H2303J
TRAIL 1250				
S (1800lm)	3000K	19W	Asimmetrica <i>Asymmetrical</i>	06TR3H2397J
		19W	Simmetrica <i>Symmetrical</i>	06TR3H2395J
		19W	Diffondente <i>Wide beam</i>	06TR3H2393J
	4000K	19W	Asimmetrica <i>Asymmetrical</i>	06TR3H2307J
		19W	Simmetrica <i>Symmetrical</i>	06TR3H2305J
		19W	Diffondente <i>Wide beam</i>	06TR3H2303J
H (3600lm)	3000K	37W	Asimmetrica <i>Asymmetrical</i>	06TR3Q4397J
		37W	Simmetrica <i>Symmetrical</i>	06TR3Q4395J
		37W	Diffondente <i>Wide beam</i>	06TR3Q4393J
	4000K	37W	Asimmetrica <i>Asymmetrical</i>	06TR3Q2307J
		37W	Simmetrica <i>Symmetrical</i>	06TR3Q4305J
		37W	Diffondente <i>Wide beam</i>	06TR3Q4303J

TRAIL: codici accessori *accessories' codes*

	06TR998J0 Controcassa per incasso a terra e parete 650mm <i>Recessed housing for wall and ground installation 650mm</i>
	06TR999J0 Controcassa per incasso a terra e parete 1250mm <i>Recessed housing for wall and ground installation 1250mm</i>
	06TR997A0 Staffe di fissaggio parete, RAL9006 <i>Bracket for wall fastening, RAL9006</i>
	06OT989A0 Box cablato per attacco parete/soffitto IP65 Trail 1250 <i>IP65 wiring box for wall/ceiling installation Trail 1250</i>
	06OT988A0 Box cablato per attacco parete/soffitto IP65 Trail 650 <i>IP65 wiring box for wall/ceiling installation Trail 650</i>
	06TR986A0 Sistema di sospensione a soffitto L 1,5 mt <i>System for ceiling suspended installation L 1,5m</i>
	06TR987A0 Staffe fissaggio plafone RAL9006, driver remoto <i>Brackets for ceiling fastening Trail, grey RAL9006</i>
	06LL914AB0 Driver elettronico 150W-24V IP67 <i>Electronic driver 150W-24V IP67</i>
	06LL915AB0 Driver elettronico 240W-24V IP67 <i>Electronic driver 240W-24V IP67</i>
	06AT902X0 Driver elettronico 60W-24V IP66 <i>Electronic driver 60W-24V IP66</i>

TRAIL: punti di forza *main strengths*

- Cablaggio rapido IP67
 - Chiusura in vetro
 - Efficienza lm/W
 - Connessioni fila continua
- *Quick electrical IP67 connection*
 - *Glass closure*
 - *Efficiency lm/W*
 - *Connection in a continuous row*

TRAIL: punti di forza *main strengths*

Cablaggio rapido + connettore IP67
Quick wiring - IP67 connector

Rapidità di cablaggio grazie al connettore rapido IP67 in dotazione in tutti gli accessori
The wiring can be carried out in a quick and easy way thanks to the IP67 connector, which is delivered with all the TRAIL accessories.

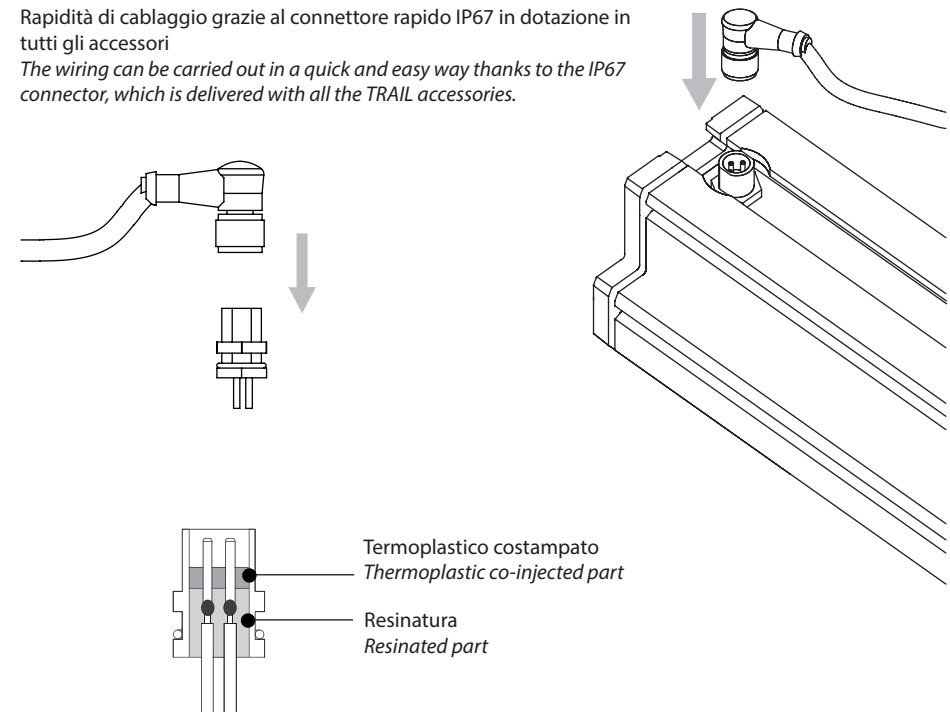

TRAIL: punti di forza *main strengths*

Vetro Glass

Vetro di chiusura sp. 6 mm. garantisce :

- calpestabilità fino a 1000 kg.
- altissima resistenza al graffio
- ottima conducibilità termica
- ottima trasmissione del flusso luminoso

The closure glass with a 6mm thickness grants:

- *A walk-over capability up to 1000 kg*
- *An extremely high resistance against scratches*
- *An excellent thermal conductivity*
- *An excellent transmission of the luminous flux*

TRAIL: ottimo rapporto lm/W *excellent lm/W ratio*

Efficienza modulo led 95 lm/W *Efficiency of the LED module: 95 lm/W*

L'ottimo posizionamento economico consente di avere un rapporto lm/€ particolarmente interessante .

Per ulteriori informazioni rivolgersi al nostro ufficio commerciale.

The excellent pricing of the product enables to have an extremely interesting lm/€ ratio.

For further information, you can address yourself to our sales department.

TRAIL: punti di forza *main strengths*

Connessione fila continua ad incasso e non *Connection in a continuous row for the recessed and non-recessed versions*

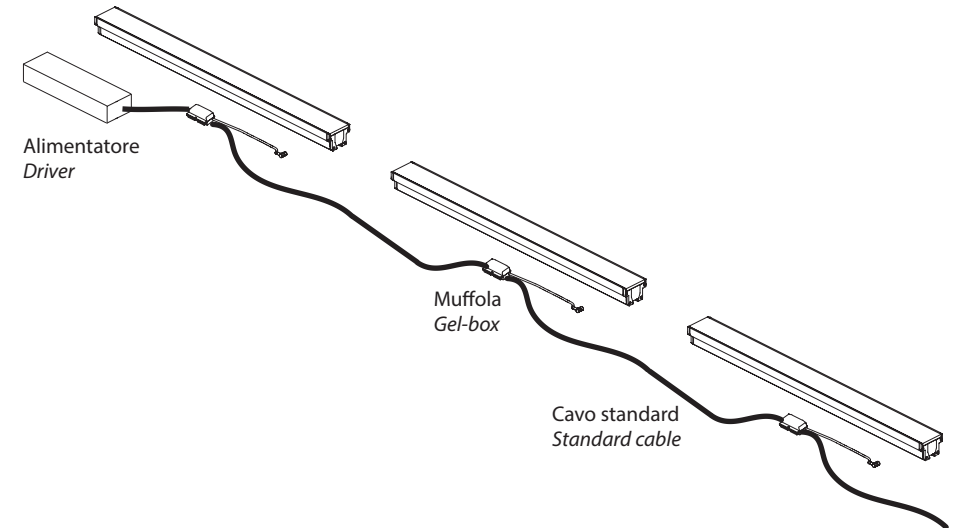

Un solo cavo di alimentazione standard che si collegherà, in entrata ed uscita, da ogni muffola fornita in dotazione con l'accessorio controccassa se la fila continua è ad incasso, o con gli accessori di fissaggio a parete o a soffitto se l'installazione è esterna.

Ad ogni muffola è collegato anche il relativo cavo con connettore stagno che si collegherà ad ogni TRAIL.

Il cavo di alimentazione terminerà all'interno della muffola corrispondente all'ultimo prodotto installato.

One single power supply cable must be connected to the gel-box, realising an In&Out connection; the gel box is delivered with all the accessories (with the recessed housings for the recessed versions and with the wall or ceiling fastening accessories for the other versions).

A cable for the connection of each TRAIL, already equipped with the watertight connector, is delivered with each gel box (already pre-connected).

The power supply cable will end in the last gel box of the last product in a row.

TRAIL: punti di forza *main strengths*

**Connessione fila continua ad incasso e non
Connection in a continuous row for the recessed and non-recessed versions**

Potenza alimentazione per collegamento su unico cavo 2x1.5mmq (in Watt)
Power supply for single cable connection of 2x1.5mmq (in Watt)

TRAIL 650 S (900 lm)

Q.TA'	0	1	2	3	4	5	6	7	8	9	10	11		12	13	14	15	16	17	18	19	20	21	22	23
0		9,36	18,72	28,08	37,44	46,8	56,16	65,52	74,88	84,24	93,6	103		112,3	121,7	131	140,4	149,8	159,1	168,5	177,8	187,2	196,6	205,9	215,3
1	18,7	28,06	37,42	46,78	56,14	65,5	74,86	84,22	93,58	102,9	112,3	121,7		131	140,4	149,7	159,1	168,5	177,8	187,2	196,5	205,9	215,3		
2	37,4	46,76	56,12	65,48	74,84	84,2	93,56	102,9	112,3	121,6	131	140,4		149,7	159,1	168,4	177,8	187,2	196,5	205,9	215,2				
3	56,1	65,46	74,82	84,18	93,54	102,9	112,3	121,6	131	140,3	149,7	159,1		168,4	177,8	187,1	196,5	205,9	215,2						
4	74,8	84,16	93,52	102,9	112,2	121,6	131	140,3	149,7	159	168,4	177,8		187,1	196,5	205,8	215,2								
5	93,5	102,9	112,2	121,6	130,9	140,3	149,7	159	168,4	177,7	187,1	196,5		205,8	215,2										
6	112,2	121,6	130,9	140,3	149,6	159	168,4	177,7	187,1	196,4	205,8	215,2													
7	130,9	140,3	149,6	159	168,3	177,7	187,1	196,4	205,8	215,1															
8	149,6	159	168,3	177,7	187	196,4	205,8	215,1																	
9	168,3	177,7	187	196,4	205,7	215,1																			
10	187	196,4	205,7	215,1																					
11	205,7	215,1																							

TRAIL 650 H (1800 lm)

Q.TA'	0	1	2	3	4	5	6	7	8	9	10	11
0		18,7	37,4	56,1	74,8	93,5	112,2	130,9	149,6	168,3	187	205,7
1	37,4	56,1	74,8	93,5	112,2	130,9	149,6	168,3	187	205,7		
2	74,8	93,5	112,2	130,9	149,6	168,3	187	205,7				
3	112,2	130,9	149,6	168,3	187	205,7						
4	149,6	168,3	187	205,7								
5	187	205,7										

Alimentatori Drivers

CODICE CODE	POTENZA (W) POWER (W)	POTENZA UTILIZZABILE (W) MAXIMUM CONNECTIBLE POWER (W)
06AT902X0	60	54,5
06LL914AB0	150	136,4
06LL915AB0	240	218,2

TRAIL: punti di forza *main strengths*

**Connessione fila continua ad incasso e non
Connection in a continuous row for the recessed and non-recessed versions**

Distanza totale per collegamento su unico cavo 2x1.5mmq (metri)
Supply power for connection with a single cable 2x1.5mmq (meters)

TRAIL 650 S (900 lm)

Q.TA'	0	1	2	3	4	5	6	7	8	9	10	11		12	13	14	15	16	17	18	19	20	21	22	23
0			549,5	305,3	213,7	164,8	134,3	113,4	98,1	86,5	77,3	69,9		63,8	58,7	54,3	50,6	47,3	44,4	41,9	39,6	37,6	35,8	34,1	32,6
1		366,6	229,1	171	137,4	115,2	99,2	87,2	77,9	70,3	64,1	58,9		54,5	50,7	47,4	44,5	42	39,7	37,7	35,8	34,1	32,6		
2	275	183,3	142,6	117,8	100,8	88,2	78,5	70,8	64,5	59,2	54,7	50,9		47,6	44,6	42,1	39,8	37,7	35,9	34,2	32,7				
3	152,8	122,2	103,1	89,6	79,4	71,4	64,9	59,5	55	51,1	47,7	44,8		42,2	39,9	37,8	35,9	34,2	32,7						
4	107	91,7	80,7	72,2	65,5	59,9	55,3	51,3	47,9	44,9	42,3	40		37,9	36	34,3	32,7								
5	82,5	73,3	66,2	60,4	55,6	51,6	48,1	45,1	42,4	40,1	38	36,1		34,4	32,8										
6	67,2	61,1	56,1	51,9	48,4	45,3	42,6	40,2	38,1	36,2	34,4	32,9													
7	56,7	52,4	48,7	45,5	42,8	40,3	38,2	36,3	34,5	32,9															
8	49,1	45,8	43	40,5	38,3	36,4	34,6	33																	
9	43,3	40,7	38,5	36,5	34,7	33,1																			
10	38,7	36,7	34,8	33,2																					
11	35	33,3																							

TRAIL 1250 S (1800 lm)

TRAIL 650 H (1800 lm)

Q.TA'	0	1	2	3	4	5	6	7	8	9	10	11
0			275	152,8	107	82,5	67,2	56,7	49,1	43,3	38,7	35
1		183,3	114,6	85,6	68,8	57,6	49,7	43,7	39	35,2		
2	137,5	91,7	71,3	58,9	50,4	44,1	39,3	35,4				
3	76,4	61,1	51,6	44,8	39,7	35,7						
4	53,5	45,8	40,3	36,1								
5	41,3	36,7										

TRAIL 1250 H (3600 lm)

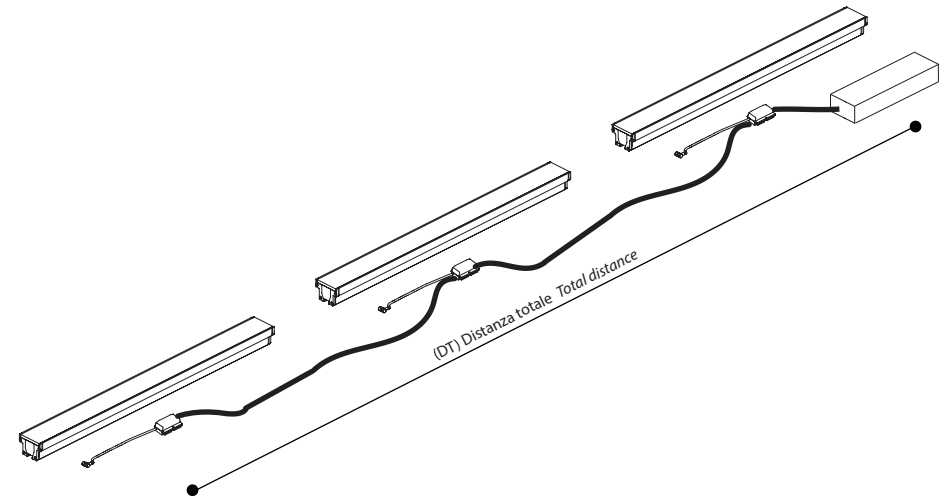

TRAIL: applicazioni *types of installation*

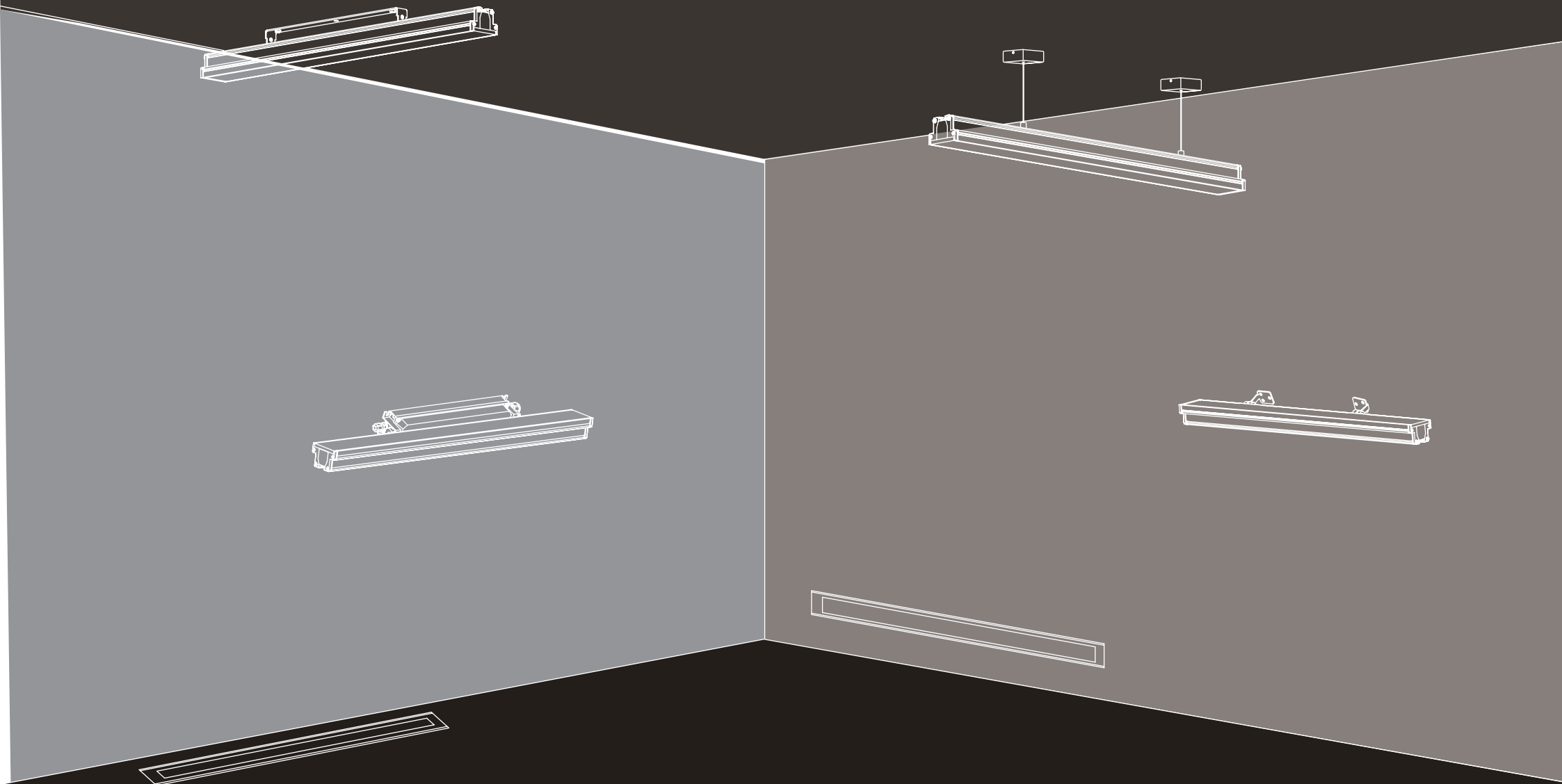

Incasso a terra e a parete
Parete
Soffitto

Ground and wall recessed installation
Wall-mounted
Ceiling-mounted

TRAIL: applicazioni *types of installation*

Incasso a terra e a parete *Ground and wall recessed installation*

Controcassa ad H adeguata per alloggiamento interno sotto ogni Trail della muffola di collegamento, del cavo di alimentazione con connettore rapido.

H-shaped recessed housing, suitable for the installation of the power supply cable and of the gel wiring box with quick connector under each Trail.

Per l'installazione ad incasso, a terra o parete, ordinare separatamente la controcassa in relazione alla lunghezza del prodotto scelto e il driver in relazione alla potenza.

For the ground and wall recessed installations, the recessed housings must be purchased separately, according to the length of the product; also the drivers must be purchased separately, according to the total power of the chosen Trail.

Controcassa 650
Recessed Housing 650

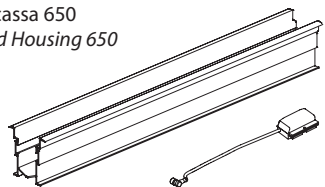

Controcassa 1250
Recessed Housing 1250

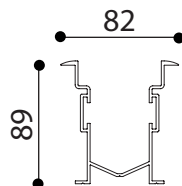
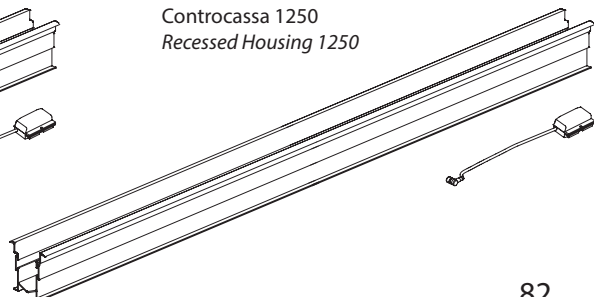

CODICE CODE	
06TR998J0	Controcassa <i>Recessed Housing 650</i>
06TR999J0	Controcassa <i>Recessed Housing 1250</i>
06AT902X0	Driver elettronico <i>Electronic driver 60W</i>
06LL914AB0	Driver elettronico <i>Electronic driver 150W</i>
06LL915AB0	Driver elettronico <i>Electronic driver 240W</i>

TRAIL: applicazioni *types of installation*

Incasso a terra e a parete *Ground and wall recessed installation*

Controcassa con inserti in polistirolo separati.

The recessed housing is equipped with polystyrene inserts.

Le protezioni in polistirolo sono realizzate in tre pezzi per consentire la rimozione della sola parte in prossimità delle testate per effettuare facilmente le operazioni di allineamento.

The polystyrene inserts are realised in three pieces; during the installation, only the two side ones must be removed, in order to enable an easy alignment of a row of recessed housings.

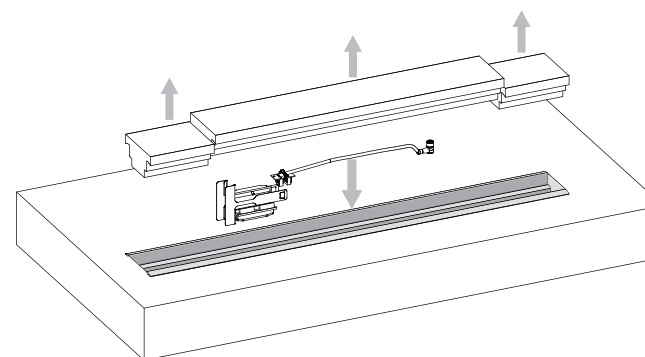

In dotazione con l'accessorio controcassa: muffola, cavo di collegamento con connettore stagno, chiavi di estrazione del prodotto e molle di allineamento.

Standard tool kit with each recessed housing: gel box, connection cable equipped with watertight connector, special tool for pulling out the fittings from the recessed housing and springs for the alignment in a row.

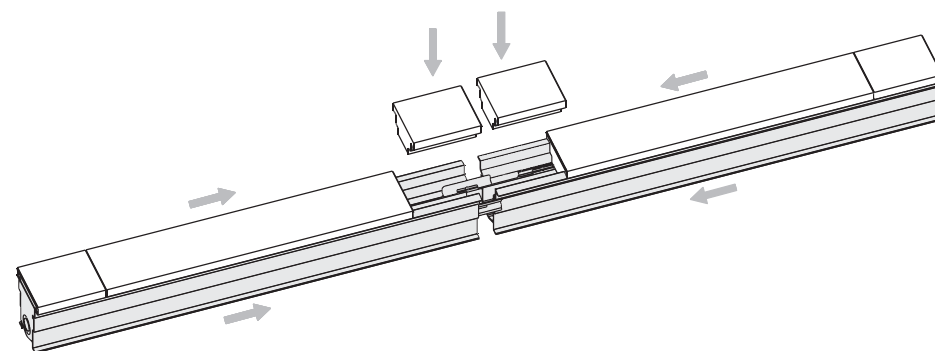

TRAIL: applicazioni *types of installation*

Incaso a terra e a parete *Ground and wall recessed installation*

Sistema di allineamento e ancoraggio prodotto
System for the alignment of the housings and for the fixing of the product

Molle di allineamento ed antivandaliche, inserite in dotazione nella controcassa svolgono la doppia funzione di:
- allineare in modo perfetto le controcasse
- garantire l'unione di tutte le controcasse rendendo così difficoltosa la rimozione vandalica del sistema.
La rimozione del Trail è invece possibile con apposita chiavetta fornita in dotazione.

Antivandalistic alignment springs
They are present in each recessed housing and they carry out a double function:
- aligning the housings in a perfect way
- granting the joining of the recessed housings and avoiding the possible vandalistic removal pr pulling out of the system; the pulling out of the Trail is always possible by means of a special tool, which is delivered in a kit with each recessed housing.

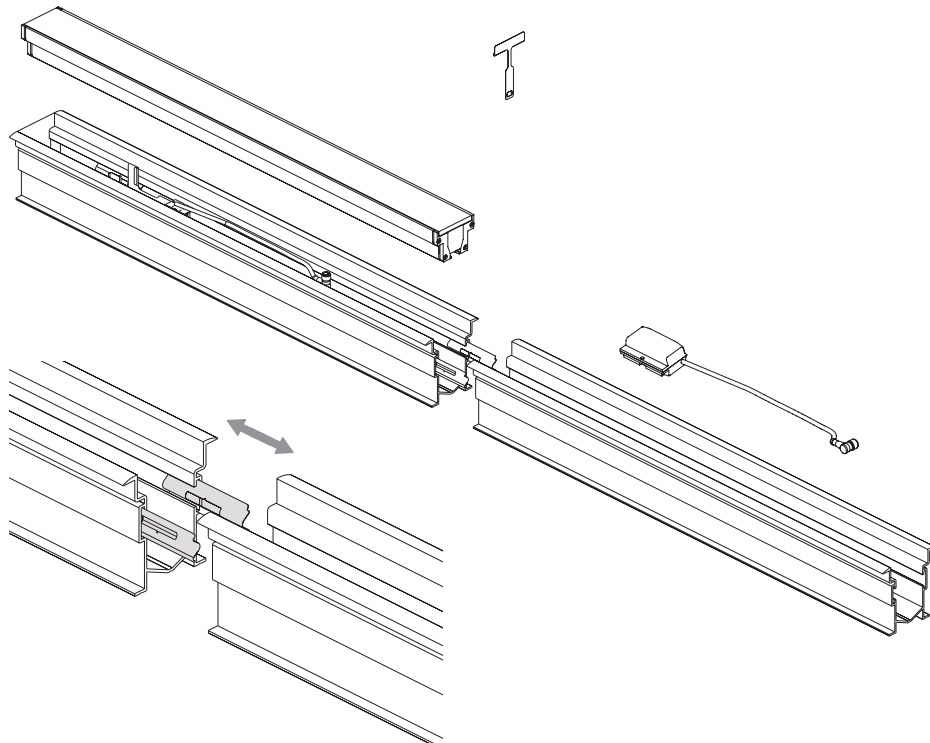

TRAIL: applicazioni *types of installation*

Parete *Wall-mounted*

Installazione con staffe
Installation with brackets

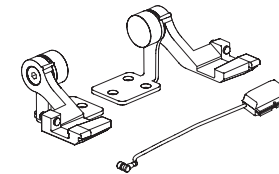

CODICE CODE	
06TR997A0	Staffe di fissaggio parete complete di muffola e cavo con connettore <i>Wall brackets, to be purchased separately, complete with a standard tool kit composed of gel box and connection cable equipped with watertight connector.</i>

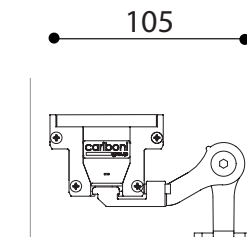
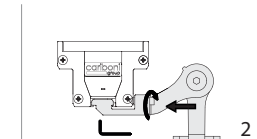
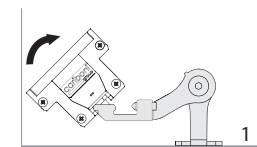
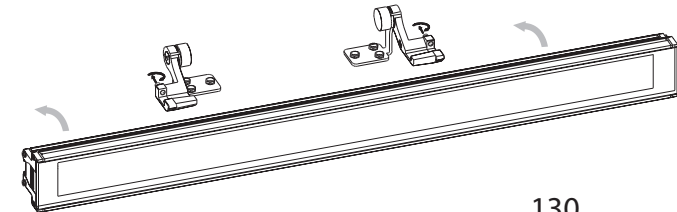
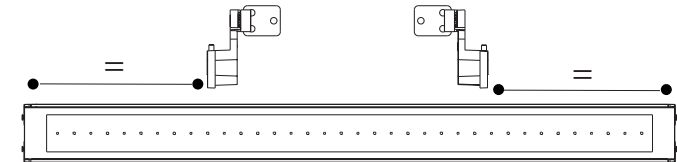
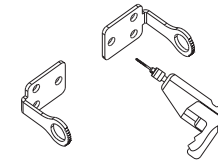

Installazione su piano orizzontale
Installation on horizontal surfaces

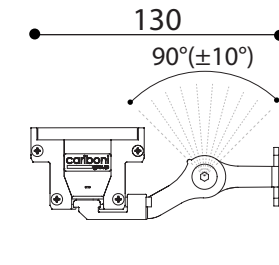

Installazione su piano verticale
Installation on vertical surfaces

CODICE CODE	DRIVER DA ORDINARE SEPARATAMENTE <i>DRIVER TO BE PURCHASED SEPARATELY</i>
06AT902X0	Driver elettronico <i>Electronic driver</i> 60W
06LL914AB0	Driver elettronico <i>Electronic driver</i> 150W
06LL915AB0	Driver elettronico <i>Electronic driver</i> 240W

TRAIL: applicazioni *types of installation*

Parete Wall-mounted

Installazione con box cablato IP65 e staffe
Installation with IP65 wiring box and brackets

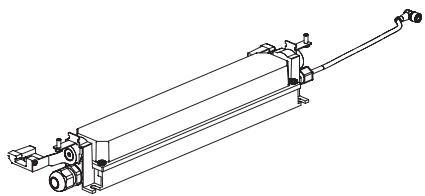

CODICE CODE	
06AT988A0	Box cablato <i>Wiring Box</i> Trail 650
06AT989A0	Box cablato <i>Wiring Box</i> Trail 1250

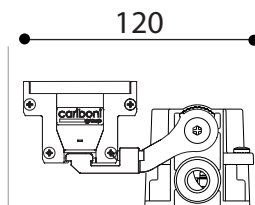
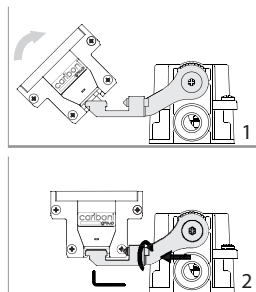
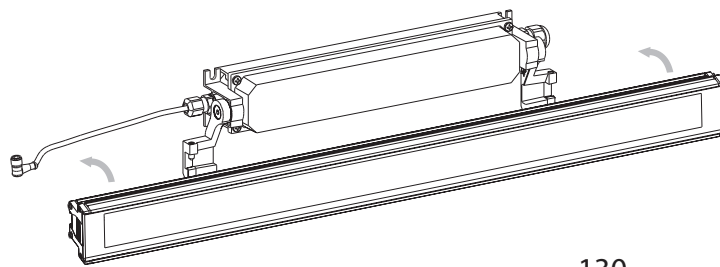
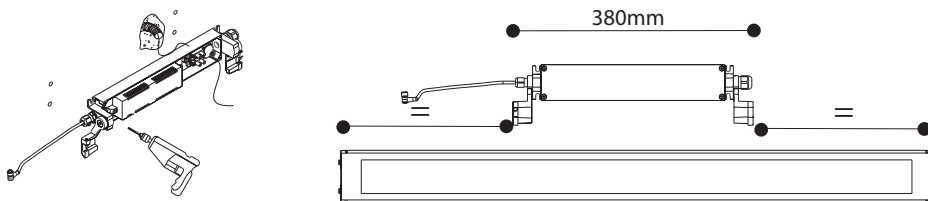

Installazione su piano orizzontale
Installation on horizontal surfaces

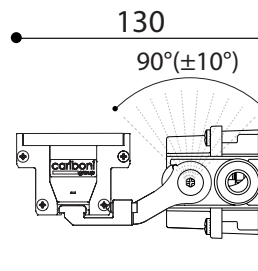

Installazione su piano verticale
Installation on vertical surfaces

TRAIL: applicazioni *types of installation*

Parete Wall-mounted

Installazione con box cablato IP65 senza staffe
Installation with IP65 wiring box without brackets

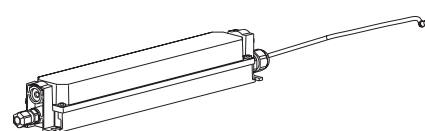

CODICE CODE	
06AT988A0	Box cablato <i>Wiring Box</i> Trail 650
06AT989A0	Box cablato <i>Wiring Box</i> Trail 1250

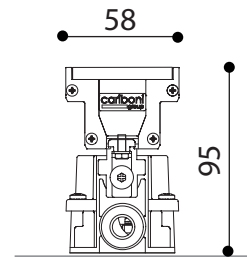
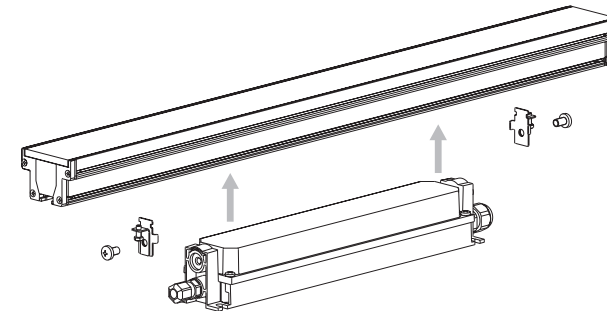
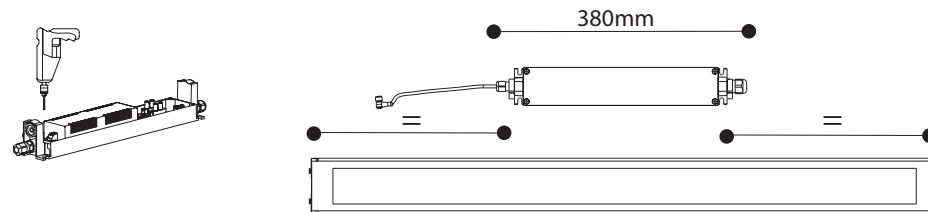

Soffitto Ceiling-mounted

Installazione con box cablato IP65 e staffe
Installation with IP65 wiring box and brackets

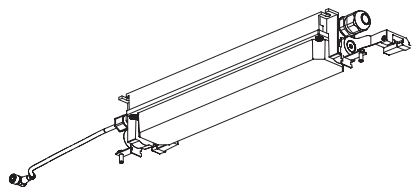

CODICE CODE	
06AT988A0	Box cablato <i>Wiring Box</i> Trail 650
06AT989A0	Box cablato <i>Wiring Box</i> Trail 1250

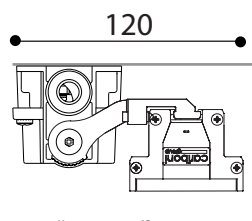
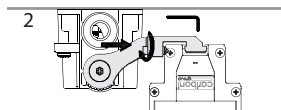
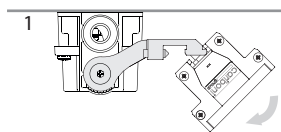
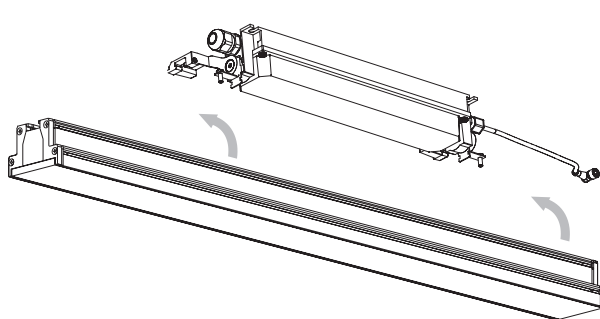
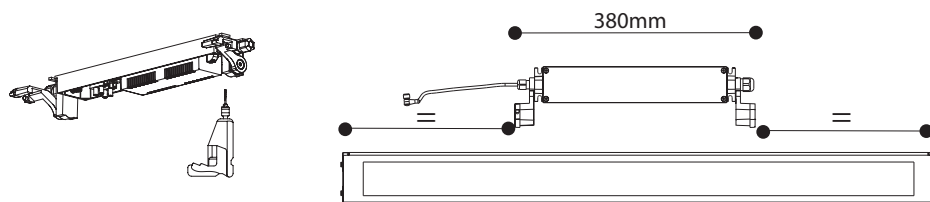

Installazione a soffitto
Ceiling installation

Soffitto Ceiling-mounted

Installazione con box cablato IP65 senza staffe
Installation with IP65 wiring box without brackets

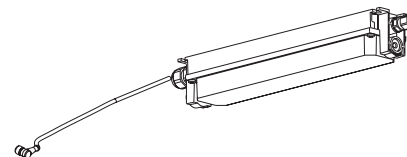

CODICE CODE	
06AT988A0	Box cablato <i>Wiring Box</i> Trail 650
06AT989A0	Box cablato <i>Wiring Box</i> Trail 1250

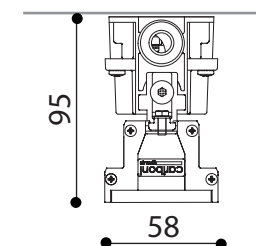
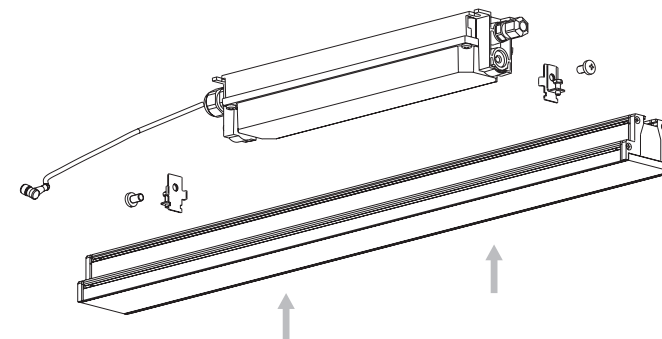
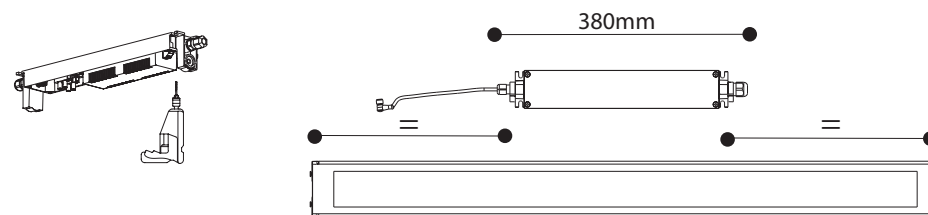

TRAIL: applicazioni *types of installation*

Soffitto Ceiling-mounted

Installazione con staffa plafone
Installation with ceiling bracket

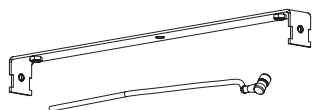

CODICE CODE	DRIVER DA ORDINARE SEPARATAMENTE DRIVER TO BE PURCHASED SEPARATELY
06TR987A0	Staffa fissaggio plafone completa di cavo con connettore <i>Brackets for ceiling fastening with connection cable equipped with watertight connector</i>
06AT902X0	Driver elettronico <i>Electronic driver</i> 60W
06LL914AB0	Driver elettronico <i>Electronic driver</i> 150W
06LL915AB0	Driver elettronico <i>Electronic driver</i> 240W

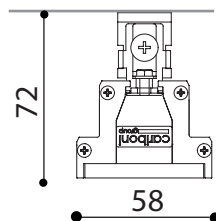
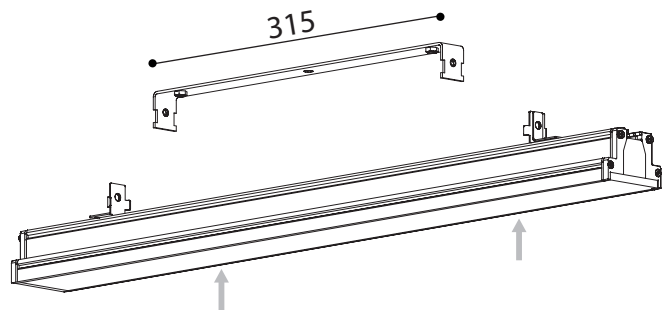
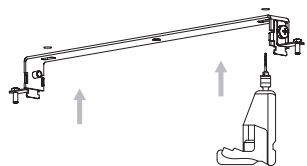

TRAIL: applicazioni *types of installation*

Soffitto Ceiling-mounted

Installazione con kit sospensione L=1,5m
Installation with suspension kit L=1,5 m

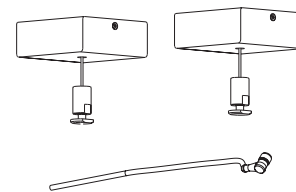

CODICE CODE	DRIVER DA ORDINARE SEPARATAMENTE DRIVER TO BE PURCHASED SEPARATELY
06TR986A0	Kit sospensione completo di cavo con connettore <i>Suspension system with connection cable equipped with watertight connector</i>
06AT902X0	Driver elettronico <i>Electronic driver</i> 60W
06LL914AB0	Driver elettronico <i>Electronic driver</i> 150W
06LL915AB0	Driver elettronico <i>Electronic driver</i> 240W

