

# N3

# LIT

LIT è un sistema completo e flessibile per l'illuminazione di vuoti e pieni urbani con una forma essenziale, moderna ed elegante.

LIT is a complete flexible system with a clean, modern and elegant shape for lighting empty and full urban locations.









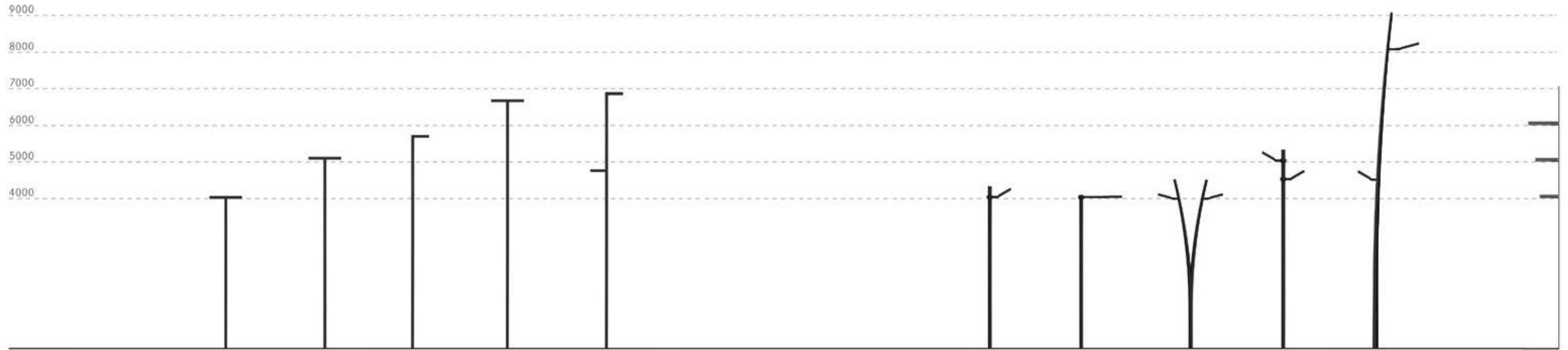

220 240V	50 60Hz	CL II	IP66	IK10	ta -30°C +50°C
-------------	------------	-------	------	------	----------------------



#### DATI PRESTAZIONALI / PERFORMANCE DATA

**Flusso apparecchio** / Fitting flux:  
2330 - 17055 lm

**Potenza apparecchio** / Fitting power:  
18,5 - 138,5 W

**Indice di resa cromatica** / Colour Rendering Index:  
CRI ≥ 70, SDCM ≤ 3

**Illuminazione intelligente** / Smart lighting:  
mezzanotte virtuale. Su richiesta ZHAGA, DALI, CLO  
virtual midnight. On request ZHAGA, DALI, CLO

#### MATERIALI / MATERIALS

**Corpo e sistemi di fissaggio** / Body and fastening system:  
pressofusione di lega di alluminio UNI EN AB 47100  
(contenuto rame < 1%) / die-cast aluminum alloy  
UNI EN AB 47100 (copper content < 1%)

**Schermo** / Screen:  
vetro piano temprato  
tempered flat glass

**Gruppo ottico** / Optical unit:  
lenti PMMA ad alta trasparenza  
high-transparency PMMA lenses

**Finitura** / Finish:  
fosfocromatazione e verniciatura in polveri di poliestere  
realizzata in 16 fasi per la miglior resistenza agli agenti  
atmosferici / phospho-chromatation treated and polyester  
powder-coated in 16 phases to increase weather resistance

#### TEMPERATURA COLORE COLOUR TEMPERATURE

- 3000 K
- 4000 K

#### COLORI / COLOURS

- SABLÉ 100 NOIR



#### CARATTERISTICHE / FEATURES

**Peso massimo** / Max weight:  
4 kg (small), 6 kg (medium), 8 kg (large)

**Alimentazione elettronica** / Electronic power supply:  
inclusa / included

**Resistenza sovratensioni** / Surge Protection Device:  
10 kV MC / MD

**Precablaggio** / pre-wiring:  
prodotto pre-cablato con cavo e connettore  
pre-wired product with cable and connector

**Installazione** / Installation:  
parete, soffitto, terra, palo  
wall, ceiling, ground, pole

## OTTICHE / OPTICS

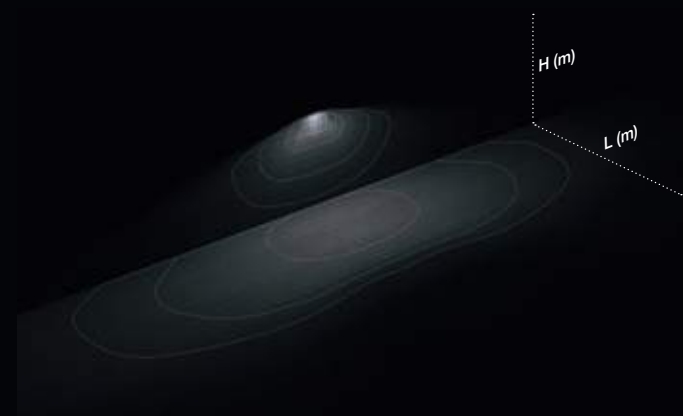
ME-03 Medium Street  
L / H = 1,1LT-62 Asymmetric Beam  
L / H = 2LA-02 Wide Street  
L / H = 1,25Lit  
Flood 1

## DATI TECNICI / TECHNICAL DATA

**Installazione / Installation:**  
parete, soffitto, terra  
wall-mounted, ceiling, ground

**Orientabilità / Orientability:**  
con giunto inclinazione  $+35^\circ + -90^\circ$ , rotazione  $\pm 30^\circ$   
with joint tilt  $+35^\circ + -90^\circ$ , rotation  $\pm 30^\circ$

SMALL

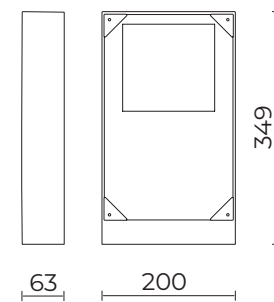

MEDIUM

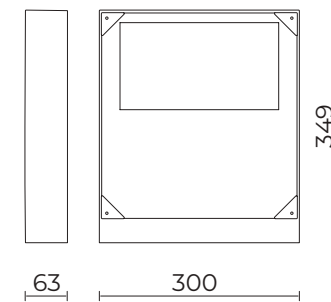

LARGE

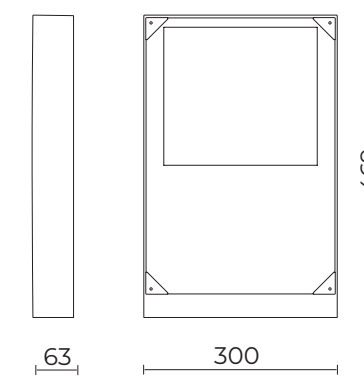

## Lit

## Lit

### Flood 1

#### ACCESSORI / ACCESSORIES

#### LIT SMALL

##### 06LT901CO

##### B110 - Giunto orientabile

Adjustable joint

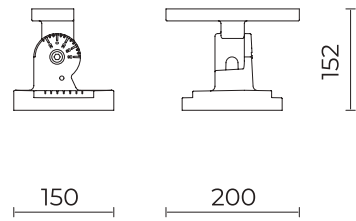

##### 06LT903CO

##### B112 - Giunto orientabile per braccio e picchetto

Adjustable joint for bracket and spike

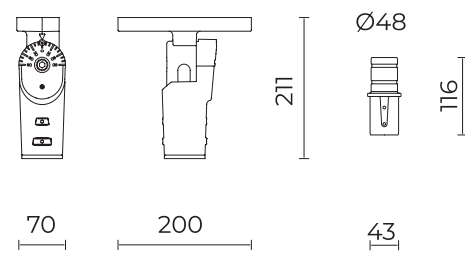

#### LIT MEDIUM - LARGE

##### 06LT902CO

##### B111 - Giunto orientabile

Adjustable joint

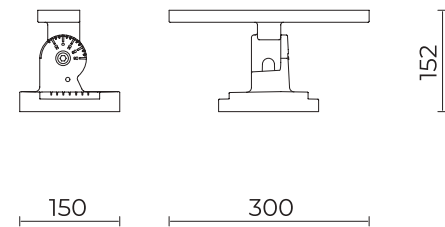

##### 06LT904CO

##### B114 - Giunto orientabile per braccio e picchetto

Adjustable joint for bracket and spike

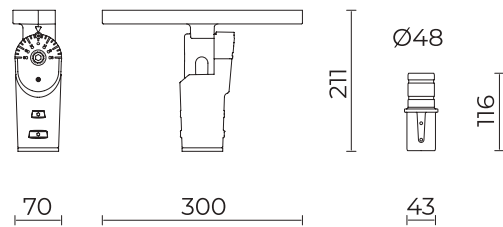

##### 06LT909JO

##### B118 - Ancore per calcestruzzo

Anchor for concrete

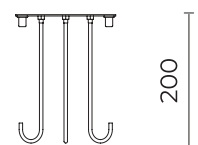

##### 06LT908CO

##### B117 - Picchetto per interrimento

Spike for ground installation

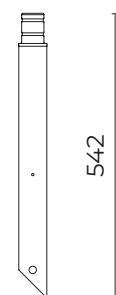

## OTTICHE / OPTICS

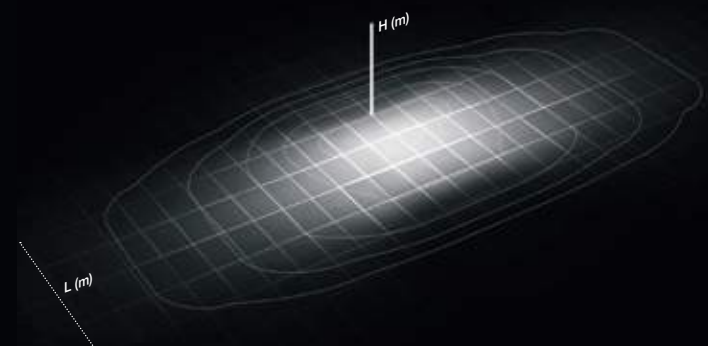
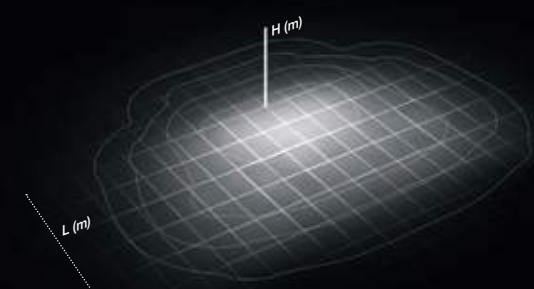
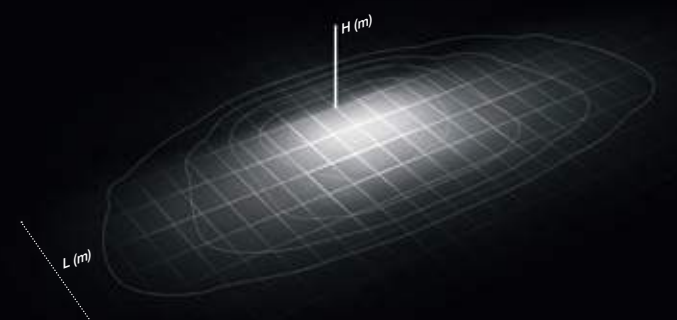
ME-03 Medium Street  
L / H = 1,1LT-62 Asymmetric Beam  
L / H = 2LA-02 Wide Street  
L / H = 1,25Lit  
System

## DATI TECNICI / TECHNICAL DATA

**Installazione / Installation:**  
palo rettangolare H 4 m, 6 m  
rectangular pole H 4 m, 6 m

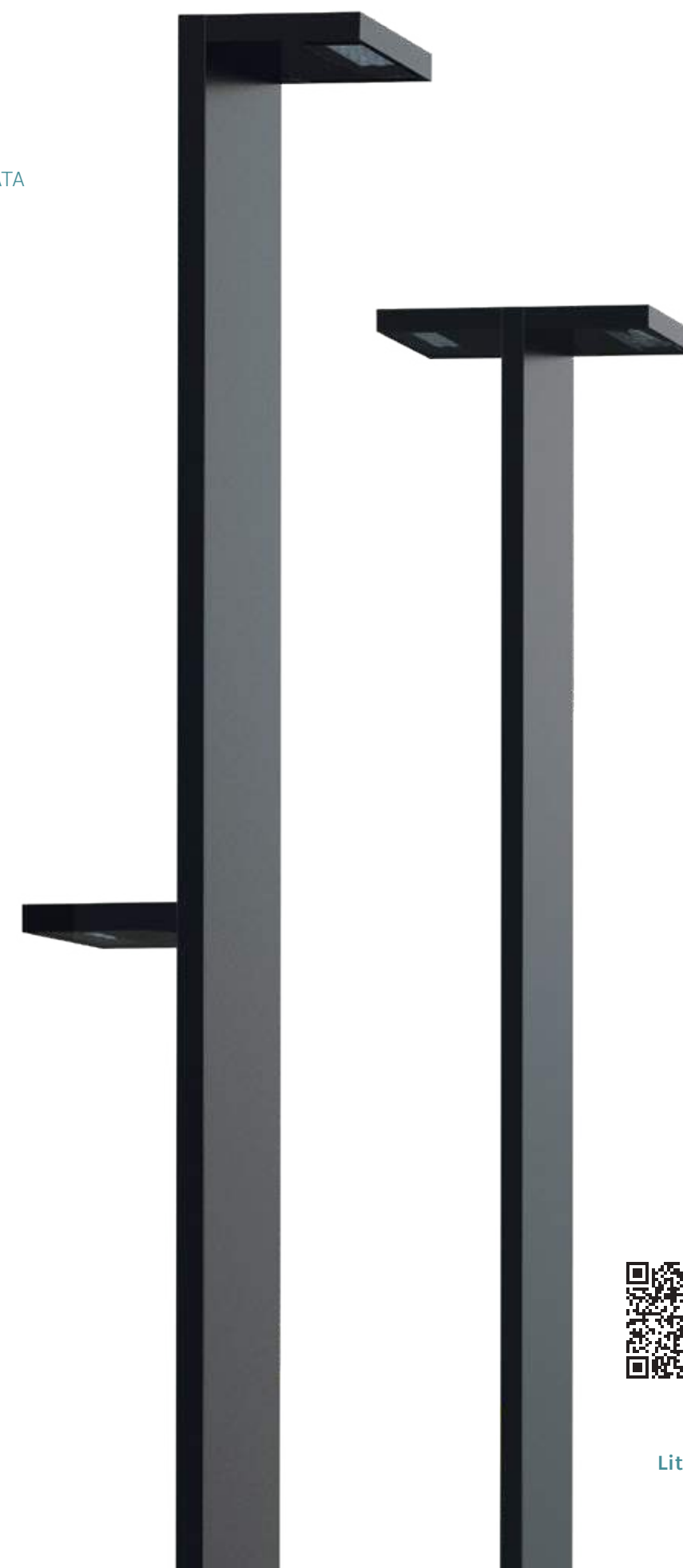



Lit  
System

## PALI / POLES

## LIT SMALL

**06LT914CO**  
**B123 - Palo in alluminio estruso H 4 m (Lit small)**  
 Aluminium extruded pole H 4 m (Lit small)

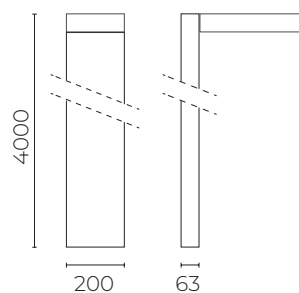

**06LT926CO**  
**B160 - Palo in alluminio estruso H 4 m (2 Lit small)**  
 Aluminium extruded pole H 4 m (2 Lit small)

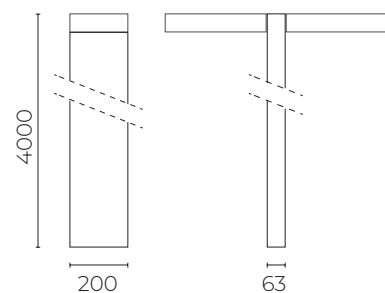

## LIT MEDIUM - LARGE

**06LT915CO**  
**B124 - Palo in alluminio estruso H 6 m (Lit medium/large)**  
 Aluminium extruded pole H 6 m (Lit medium/large)

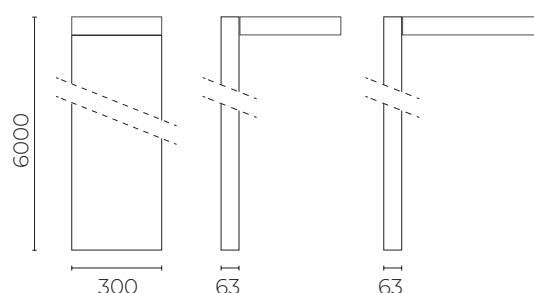

**06LT927CO**  
**B161 - Palo in alluminio estruso H 6 m (2 Lit medium/large)**  
 Aluminium extruded pole H 6 m (2 Lit medium/large)

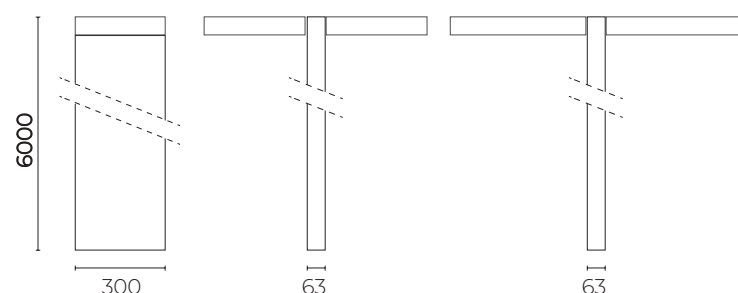

**06LT928CO**  
**B162 - Palo in alluminio estruso H 6 m per 2 Lit medium / large (H 4 m e H 6 m)**  
 Aluminium extruded pole H 6 m for 2 Lit medium / large (H 4 m and H 6 m)

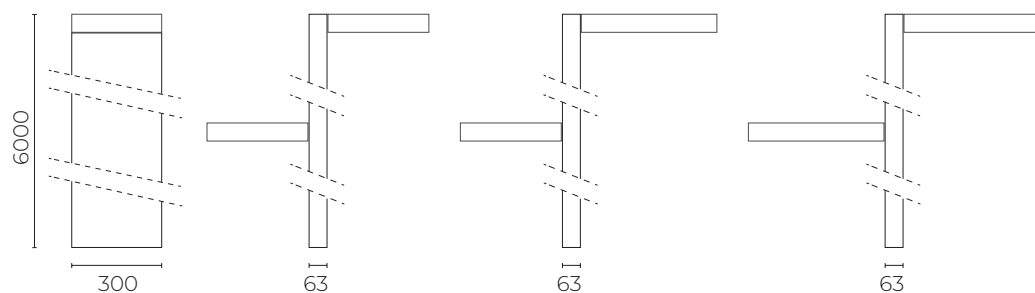

OTTICHE / OPTICS

ME-03 Medium Street  
L / H = 1,1

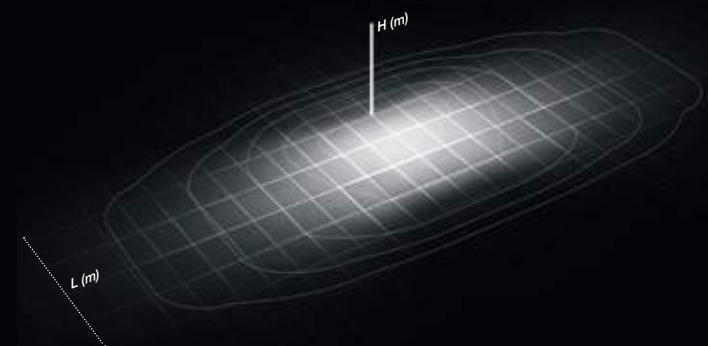

LT-62 Asymmetric Beam  
L / H = 2

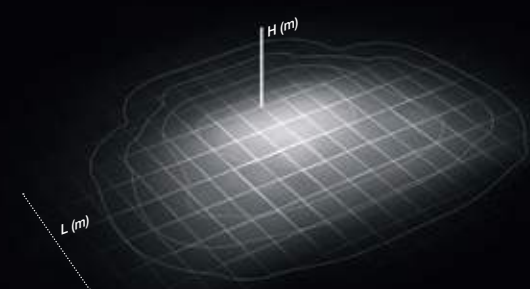

LA-02 Wide Street  
L / H = 1,25

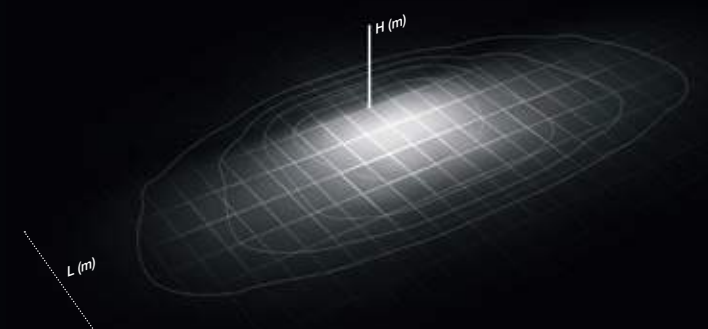

Lit  
Poles

DATI TECNICI / TECHNICAL DATA

**Installazione / Installation:**  
con collare su pali Ø 60 - 76 - 102 mm  
with collar on poles Ø 60 - 76 - 102 mm



## Lit

### Poles

#### ACCESSORI / ACCESSORIES

#### LIT SMALL

**06LT929C0**  
**B166 - Collare singolo per pali**  
**Ø 60 mm / Single collar for**  
**poles Ø 60 mm**

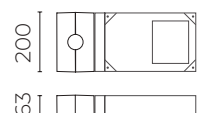

**06LT930C0**  
**B167 - Collare doppio per pali**  
**Ø 60 mm / Double collar for**  
**poles Ø 60 mm**

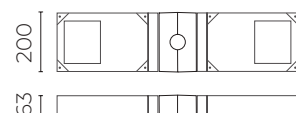

**06LT910C0**  
**B119 - Collare singolo**  
**per pali Ø 76 mm / Single**  
**collar for poles Ø 76 mm**

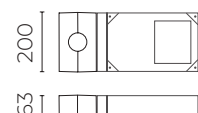

**06LT937C0**  
**B174 - Collare singolo per pali**  
**Ø 76 mm / Single collar for**  
**poles Ø 76 mm**

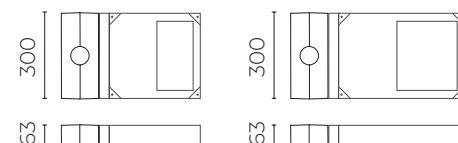

**06LT938C0**  
**B175 - Collare doppio per pali Ø 76 mm**  
**Double collar for poles Ø 76 mm**

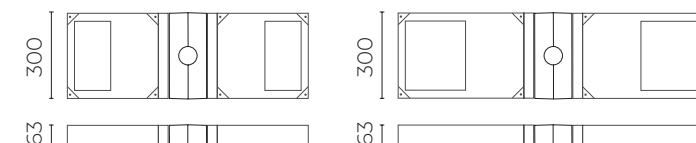

**06LT911C**  
**B120 - Collare doppio per pali**  
**Ø 76 mm / Double collar for**  
**poles Ø 76 mm**

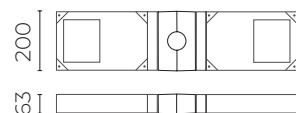

**06LT933C0**  
**B170 - Collare singolo per pali**  
**Ø 102 mm / Single collar for**  
**poles Ø102 mm**

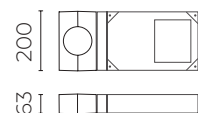

**06LT934C0**  
**B171 - Collare doppio per**  
**pali Ø 102 mm / Double**  
**collar for poles Ø102 mm**

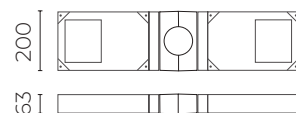

**06LT912C0**  
**B121 - Collare singolo per pali**  
**Ø 102 mm / Single collar for**  
**poles Ø 102 mm**

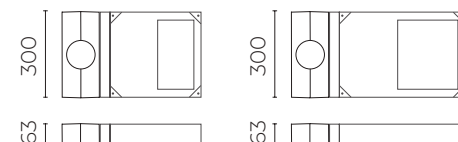

**06LT913C0**  
**B122 - Collare doppio per pali Ø 102 mm**  
**Double collar for poles Ø 102 mm**

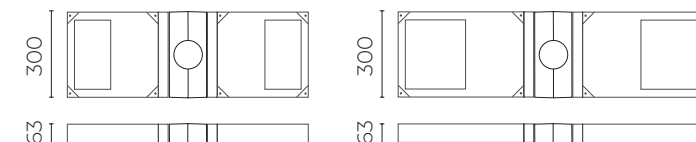

#### LIT MEDIUM - LARGE

**06LT935C0**  
**B172 - Collare singolo per pali Ø 60 mm**  
**Single collar for poles Ø 60 mm**

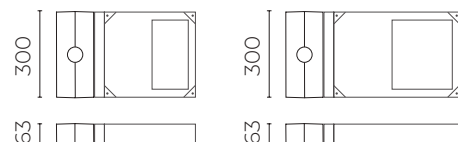

**06LT936C0**  
**B173 - Collare doppio per pali Ø 60 mm**  
**Double collar for poles Ø 60 mm**

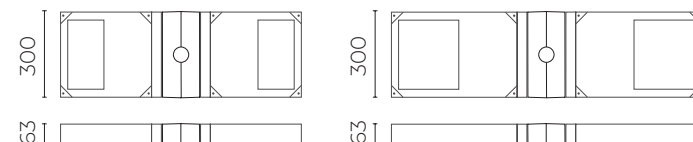





MILAN  
Italy



GENOVA  
Italy

ATHENS  
Greece





## OTTICHE / OPTICS

ME-03 Medium Street  
L / H = 1,1

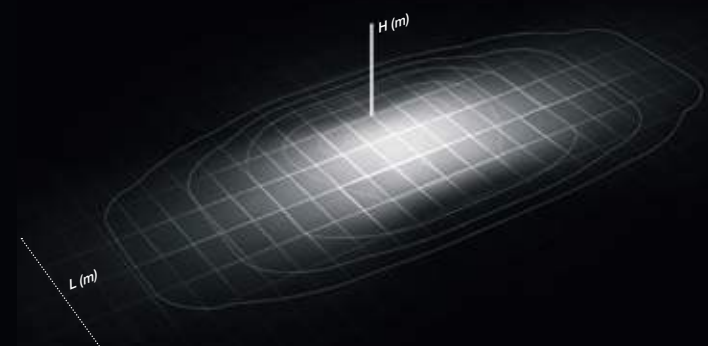

LT-62 Asymmetric Beam  
L / H = 2

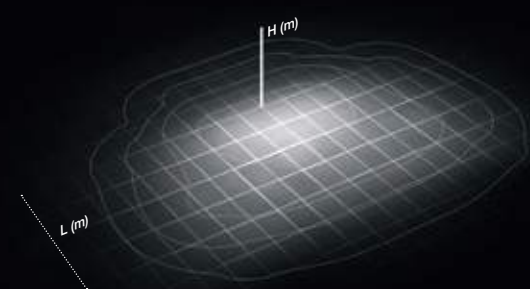

LA-02 Wide Street  
L / H = 1,25

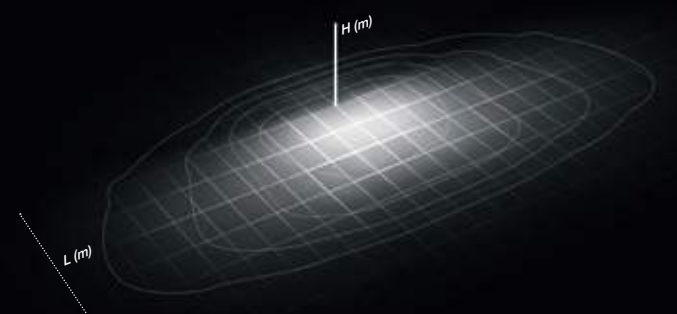

## Lit

Brackets and poles

### DATI TECNICI / TECHNICAL DATA

**Installazione / Installation:**  
con accessori su pali Ø 60 - 76 - 102 mm  
with accessories on poles Ø 60 - 76 - 102 mm

**Inclinazione / Inclination:**  
-90°



## Lit

## Brackets and poles

## ACCESSORI E BRACCI / ACCESSORIES AND ARMS:

**06LT903CO****B112 - Giunto orientabile per braccio**

Ø 60 mm Lit small

Adjustable joint for bracket Ø 60 mm Lit small

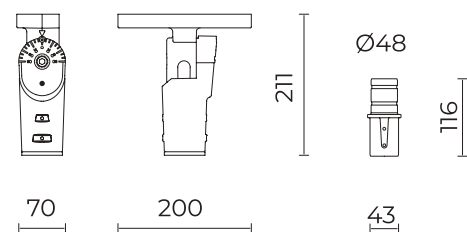
**06LT904CO****B114 - Giunto orientabile per braccio**

Ø 60 mm Lit medium, large / Adjustable joint

for bracket Ø 60 mm Lit medium, large

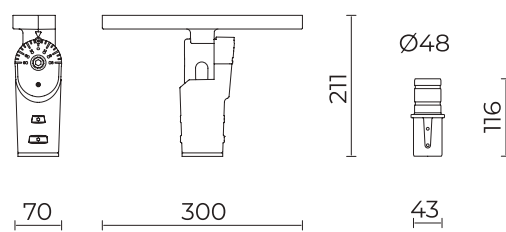
**01AK921CO****B1 - Braccio per pali**

Arm for poles

Ø60-76

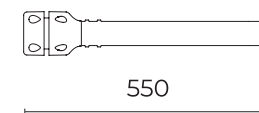
**01AK922CO****B2 - Braccio doppio per pali**

Double arm for poles

Ø60-76

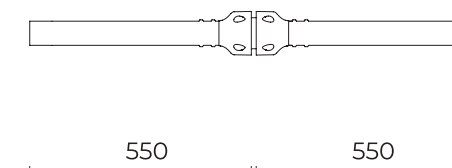
**01AK903CO****L3 - Kit giunto per palo o braccio**

Joint kit for pole or arm

Ø60-76

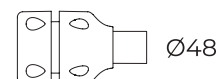
**01AK904CO****L4 - Kit giunto doppio per palo o braccio**

Double joint kit for pole or arm

Ø60-76

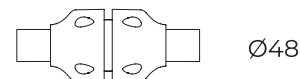
**06AK907CO****B155 - Braccio per pali**

Arm for poles

Ø102

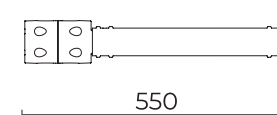
**06AK909CO****B157 - Braccio doppio per pali**

Double arm for poles

Ø102

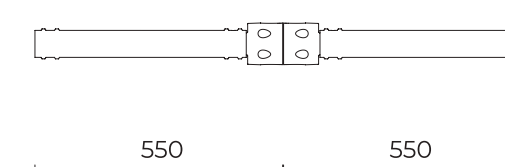
**06AK916CO****B139 - Anello per pali**

Ring for poles

Ø102

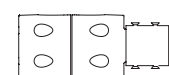
**06AK917CO****B140 - Anello doppio per pali**

Double ring for poles

Ø102

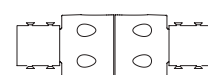

**Metalmek Lighting B.V**

Canadabaan7-d  
5388 RT Nistelrode  
Tel. 0412-614033

[info@metalmek.nl](mailto:info@metalmek.nl)  
[www.metalmek.nl](http://www.metalmek.nl)

**Metalmek**

**Cariboni**  
group

 **LIVAL**

**NORDIC**  **ALUMINIUM**