

N3

KOSMOS

KOSMOS è un sistema completo e flessibile per l'illuminazione di vuoti e pieni urbani: percorsi, spazi e architetture.

KOSMOS is a complete flexible system for lighting empty and full urban locations: pathways, spaces and architecture.





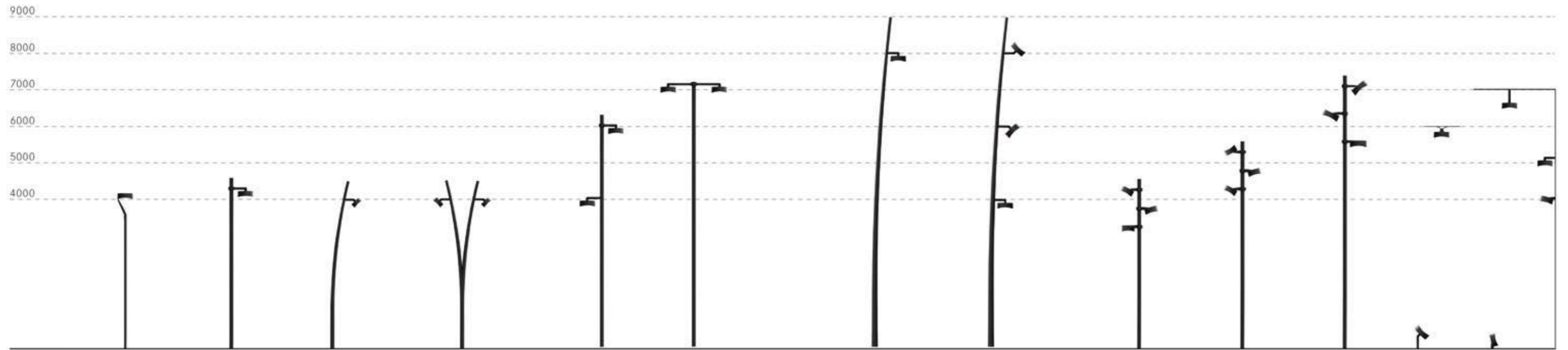

220 240V	50 60Hz	CL II	IP66	IK09	ta -30°C +50°C
-------------	------------	-------	------	------	----------------------



DATI PRESTAZIONALI / PERFORMANCE DATA

Flusso apparecchio / Fitting flux:
1355 (1800 K) - 16150 lm

Potenza apparecchio / Fitting power:
12 - 108 W

Indice di resa cromatica / Colour Rendering Index:
CRI ≥ 70, SDCM ≤ 3

Illuminazione intelligente / Smart Lighting:
mezzanotte virtuale. Su richiesta DALI, ZHAGA, CLO, PLC, telegestione wireless
virtual midnight. On request DALI, ZHAGA, CLO, PLC, wireless telemanagement

MATERIALI / MATERIALS

Corpo e sistemi di fissaggio / Body and fitting system:
pressofusione di lega d'alluminio UNI EN AB 47100 (contenuto rame < 1%) / die-cast aluminum alloy UNI EN AB 47100 (copper content < 1%)

Schermo / Screen:
vetro piano temprato / tempered flat glass

Gruppo ottico / Optical unit:
lenti PMMA ad alta trasparenza
high-transparency PMMA lenses

Finitura / Finish:
fosfocromatazione e verniciatura in polveri di poliestere realizzata in 16 fasi per la miglior resistenza agli agenti atmosferici / phospho-chromatation treated and polyester powder-coated in 16 phases to increase weather resistance

COLORI / COLOURS

● SABLÉ 100 NOIR

ECO-CENTRIC LIGHTING (ECL)

(ONLY FOR STREET OPTICS)

BLUE FREE LIGHT:

PC-AMBER 0,7% ΣR ($\lambda < 500\text{NM}$) – CRI 40
1800 K 4,3% ΣR ($\lambda < 500\text{NM}$) – CRI 70

SWITCHABLE WHITE LIGHT:

1800K / 3000K

CARATTERISTICHE / FEATURES

Peso massimo / Max weight:
3,5 kg (small), 7,5 kg (medium)

Alimentazione elettronica / Electronic power supply:
inclusa / included

Resistenza sovratensioni / Surge Protection Device:
10 kV MC/MD

Precablaggio / Pre-wiring:
prodotto pre-cablato con cavo e connettore
pre-wired product with cable and connector

Installazione / Installation:
testa palo, lato palo, sospensione braccio, sospensione tesata, parete, sottoportico
post top, pole side, suspension arm, string suspension, wall, arcade





ODENA
Spain



KIEV
Ukraine



NERVI
Italy



CAPACCIO PAESTUM
Italy

OTTICHE / OPTICS

LT-C1 Cycle Path
L / H = 0,5

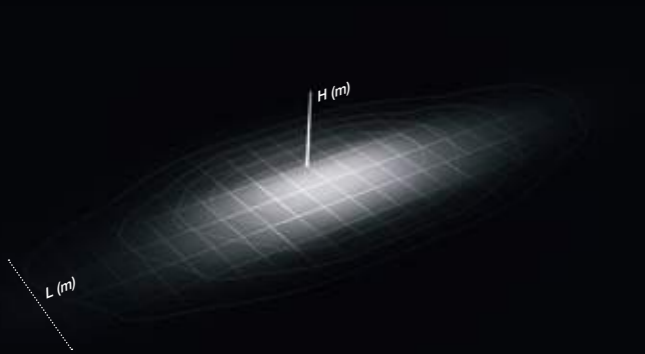

LA-03 Wide Street
L / H = 1,25

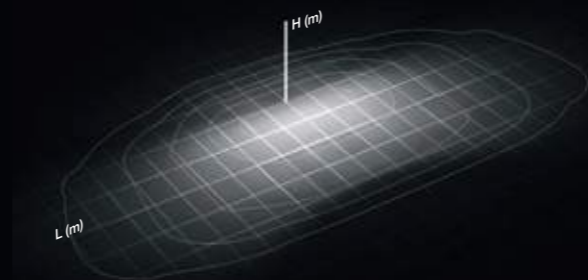

ECL

ST-02 Narrow Street
L / H = 0,75

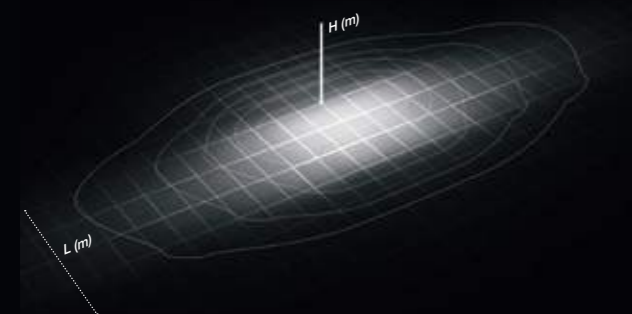

ECL

LT-64 Asymmetric Beam with backlight
L / H = 2

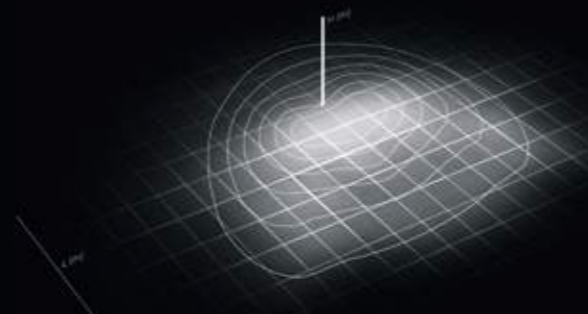

ECL

ME-05 Medium Street
L / H = 1

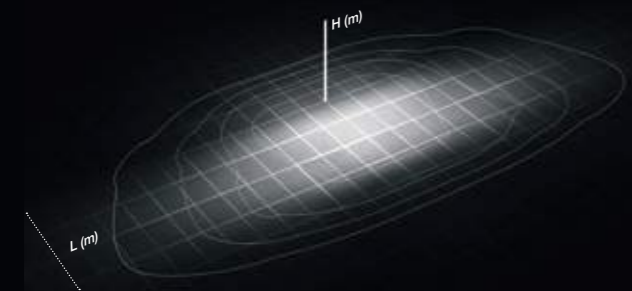

ECL

RS-02 Rotosymmetric Beam
L / H = 2

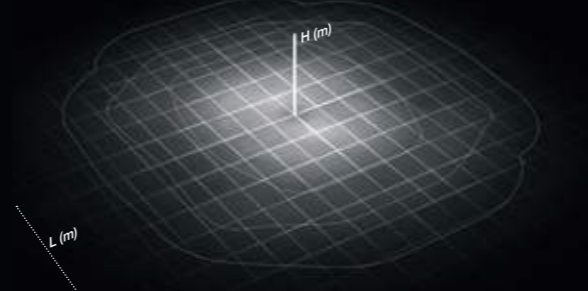

Kosmos
Testa palo / Post top

DATI TECNICI / TECHNICAL DATA

Installazione / Installations:
con accessorio 06KS901C0 su pali Ø 76 mm, con riduzione Ø 60 mm / with accessory 06KS901C0 on poles Ø 76 mm, with reduction Ø 60 mm

MEDIUM

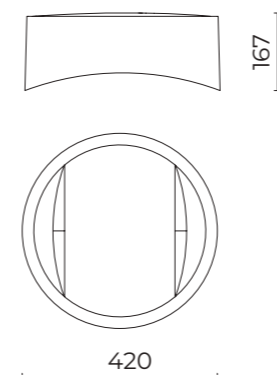

TEMPERATURA COLORE / COLOUR TEMPERATURE

- 2200 K
- 2700 K
- 3000 K
- 4000 K

ACCESSORI / ACCESSORIES

06KS901C0
B81 - Chela testa palo, innesto
H 90 mm / Arm for post top,
fastening part H 90 mm

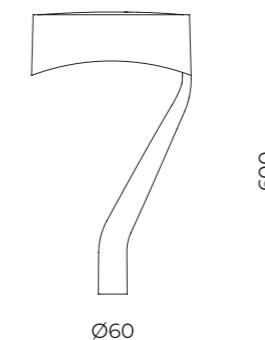

OTTICHE / OPTICS

LT-C1 Cycle Path
L / H = 0,5

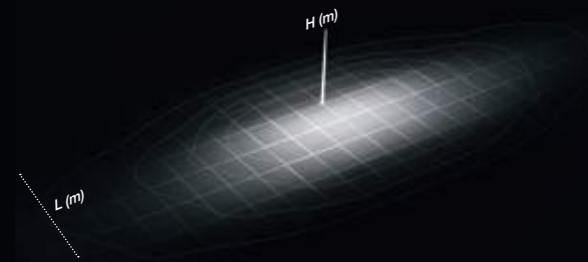

PB-01 Low Pole
L / H = 2

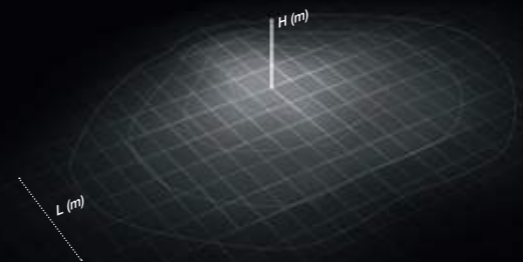

ST-02 Narrow Street
L / H = 0,75

ECL

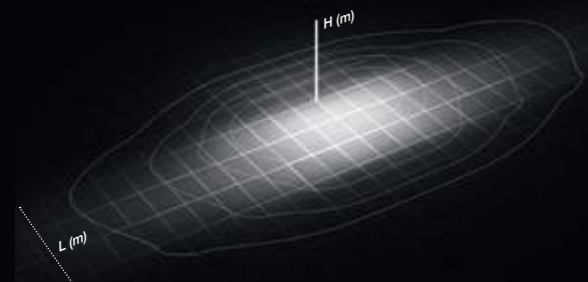

AP-D2 Pedestrian Crossing

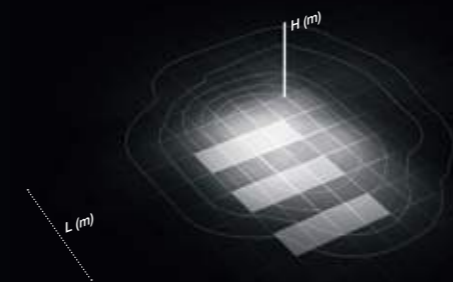

ME-05 Medium Street
L / H = 1

ECL

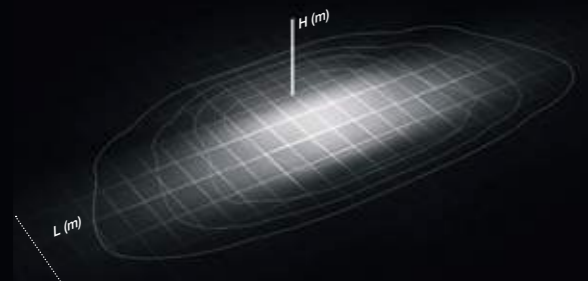

AP-S2 Pedestrian Crossing

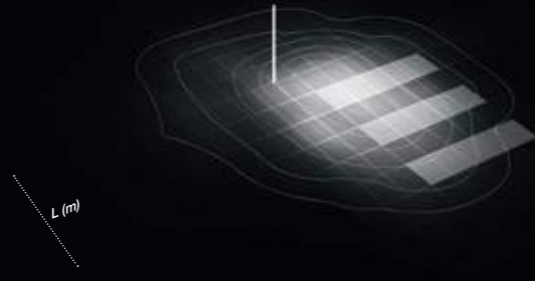

LA-03 Wide Street
L / H = 1,25

ECL

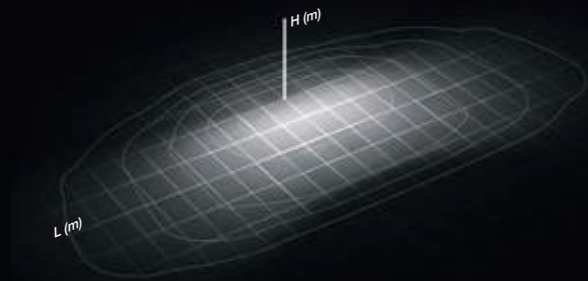

LT-64 Asymmetric Beam with backlight
L / H = 2

ECL

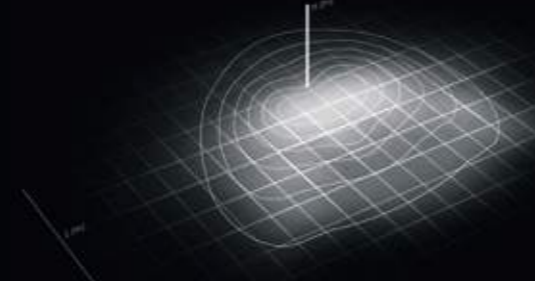

Lato palo / Pole side



DATI TECNICI / TECHNICAL DATA

Installazione / Installation:
con accessori, su pali Ø 60 - 76 - 102 mm
with accessories, on poles Ø 60 - 76 - 102 mm

Inclinazione / Inclination:
regolazione continua -10° ÷ +190° (in step da 5°)
continuous adjustment -10° ÷ +190° (step 5°)

SMALL

MEDIUM

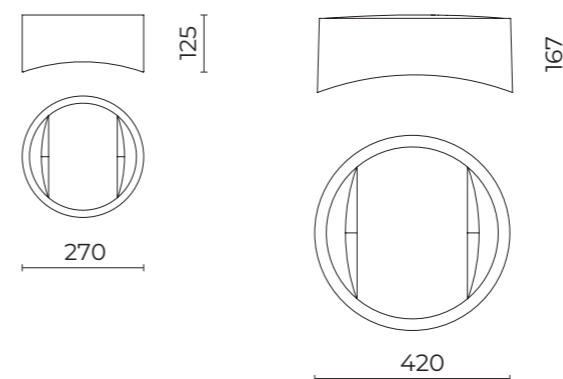

TEMPERATURA COLORE
COLOUR TEMPERATURE

- 2200 K
- 2700 K
- 3000 K
- 4000 K



Kosmos
Lato palo / Pole side

ACCESSORI / ACCESSORIES

KOSMOS SMALL

06ND901Y0
Diffusore policarbonato trasparente
Transparent polycarbonate diffuser

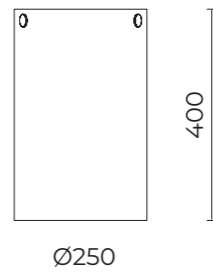

KOSMOS SMALL - MEDIUM

06KS904C0
B84 - Snodo per bracci
Joint for arms

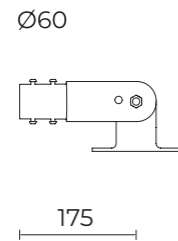

06KS906C0
B86 - Giunto testa palo, codolo H 90 mm
Joint for post top, fastening part H 90 mm

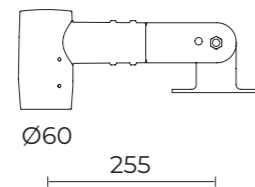

06KS907C0
B87 - Braccio per pali
Arm for poles

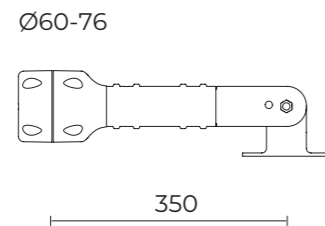

06KS912C0
B92 - Braccio per pali
Arm for poles

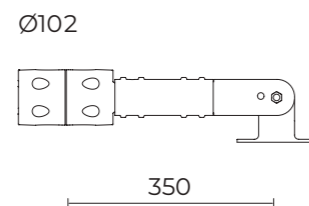

KOSMOS SMALL - MEDIUM

06KS908C0
B88 - Braccio per pali
Arm for poles

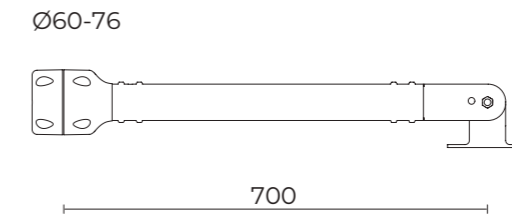

06KS913C0
B93 - Braccio per pali
Arm for poles

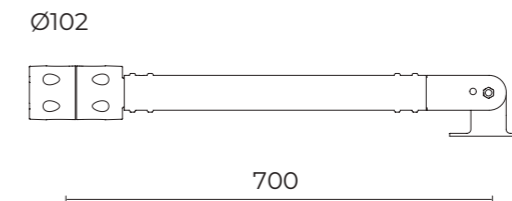

06KS910C0
B90 - Braccio doppio per pali
Double arm for poles

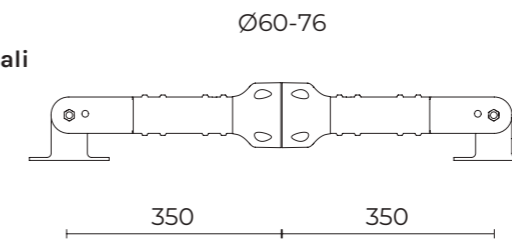

06KS914C0
B94 - Braccio doppio per pali
Double arm for poles

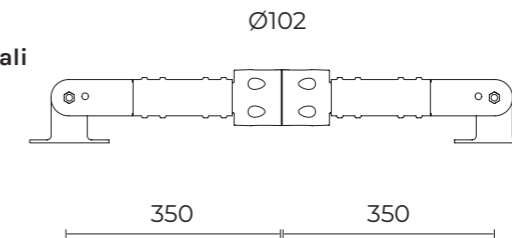

06KS911C0
B91 - Braccio doppio per pali
Double arm for poles

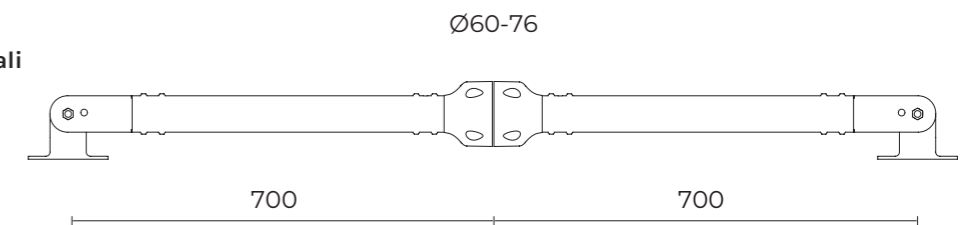

06KS915C0
B95 - Braccio doppio per pali
Double arm for poles

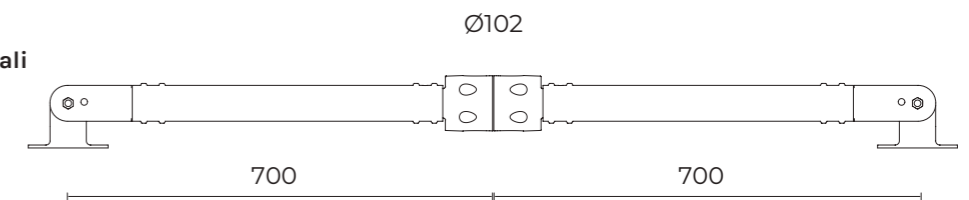



OTTICHE / OPTICS

LT-C1 Cycle Path
L / H = 0,5

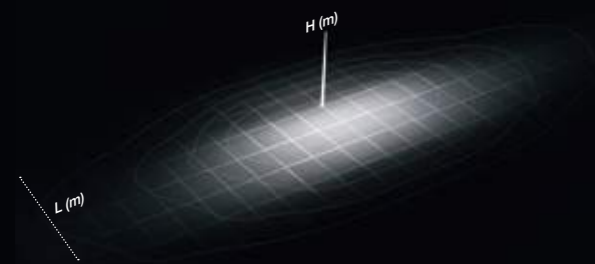

PB-01 Low Pole
L / H = 2

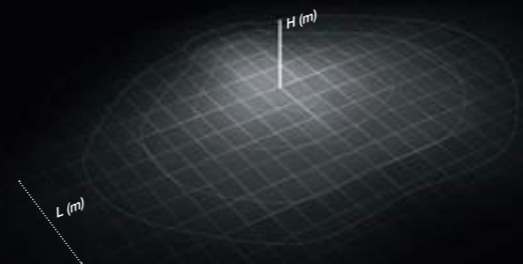

ST-02 Narrow Street
L / H = 0,75

ECL

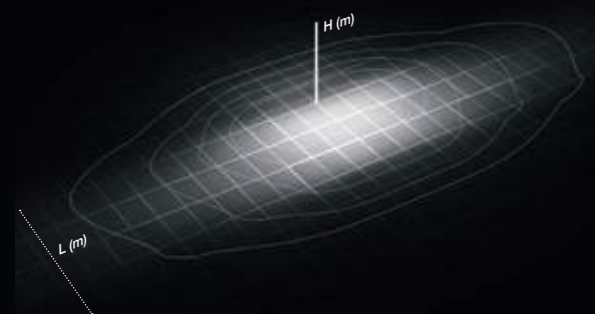

AP-D2 Pedestrian Crossing

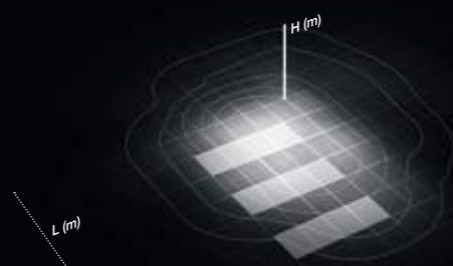

ME-05 Medium Street
L / H = 1

ECL

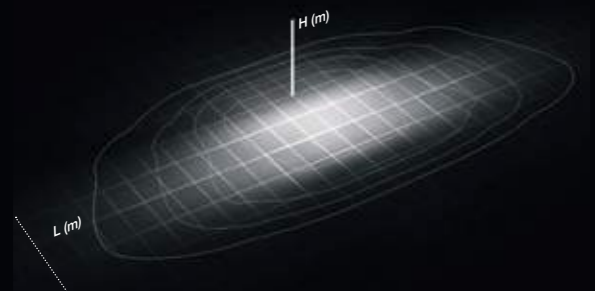

AP-S2 Pedestrian Crossing

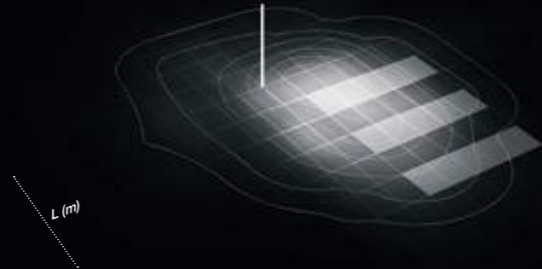

LA-03 Wide Street
L / H = 1,25

ECL

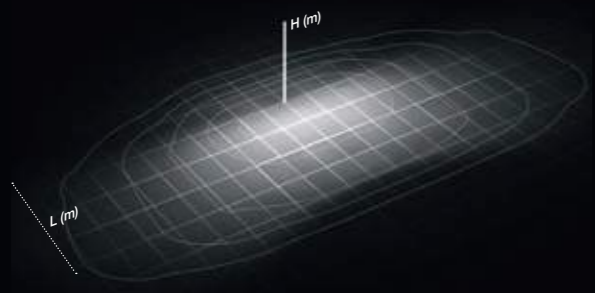

LT-64 Asymmetric Beam with backlight
L / H = 2

ECL

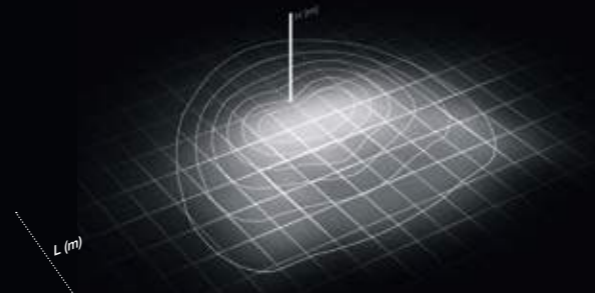

Sospensione braccio / Arm suspension

DATI TECNICI / TECHNICAL DATA

Installazione / Installation:
con accessorio 06KS903C0 su bracci
per pali Ø 102 mm
with accessory 06KS903C0 on arms
for poles Ø 102 mm



SMALL

MEDIUM

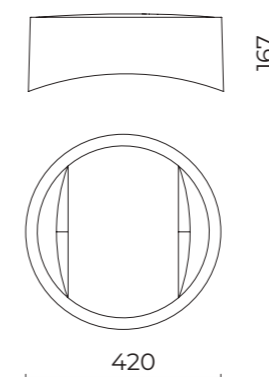
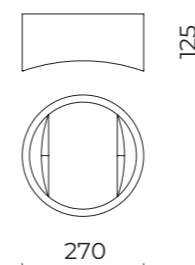

TEMPERATURA COLORE
COLOUR TEMPERATURE

- 2200 K
- 2700 K
- 3000 K
- 4000 K



Kosmos

Sospensione braccio / Arm suspension

ACCESSORI / ACCESSORIES

06KS903C0
B79 - Kit fissaggio su bracci pastorali
Fastening kit on curved arms

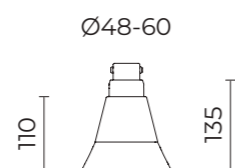

01AK935C0
B15 - Braccio pastorale per pali
Curved arm for poles

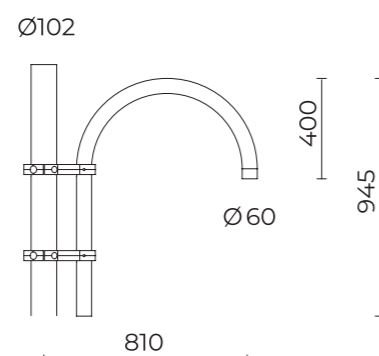

01AK936C0
B16 - Braccio pastorale doppio per pali
Double curved arm for poles

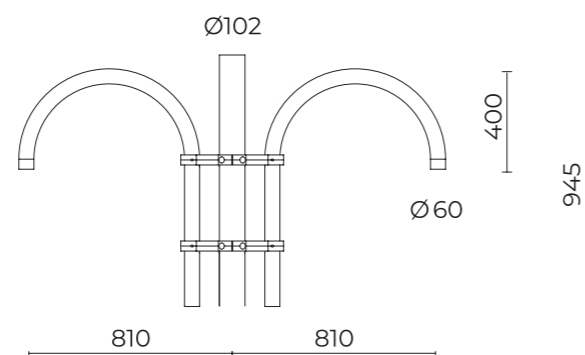

01AK950C0
B1-P - Braccio pastorale parete
Curved arm for wall

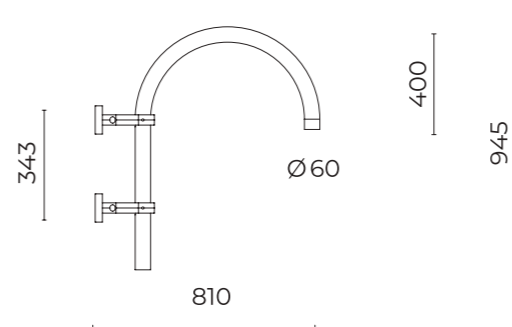

LT-63 Asymmetric Beam

SO-02 Street Centered

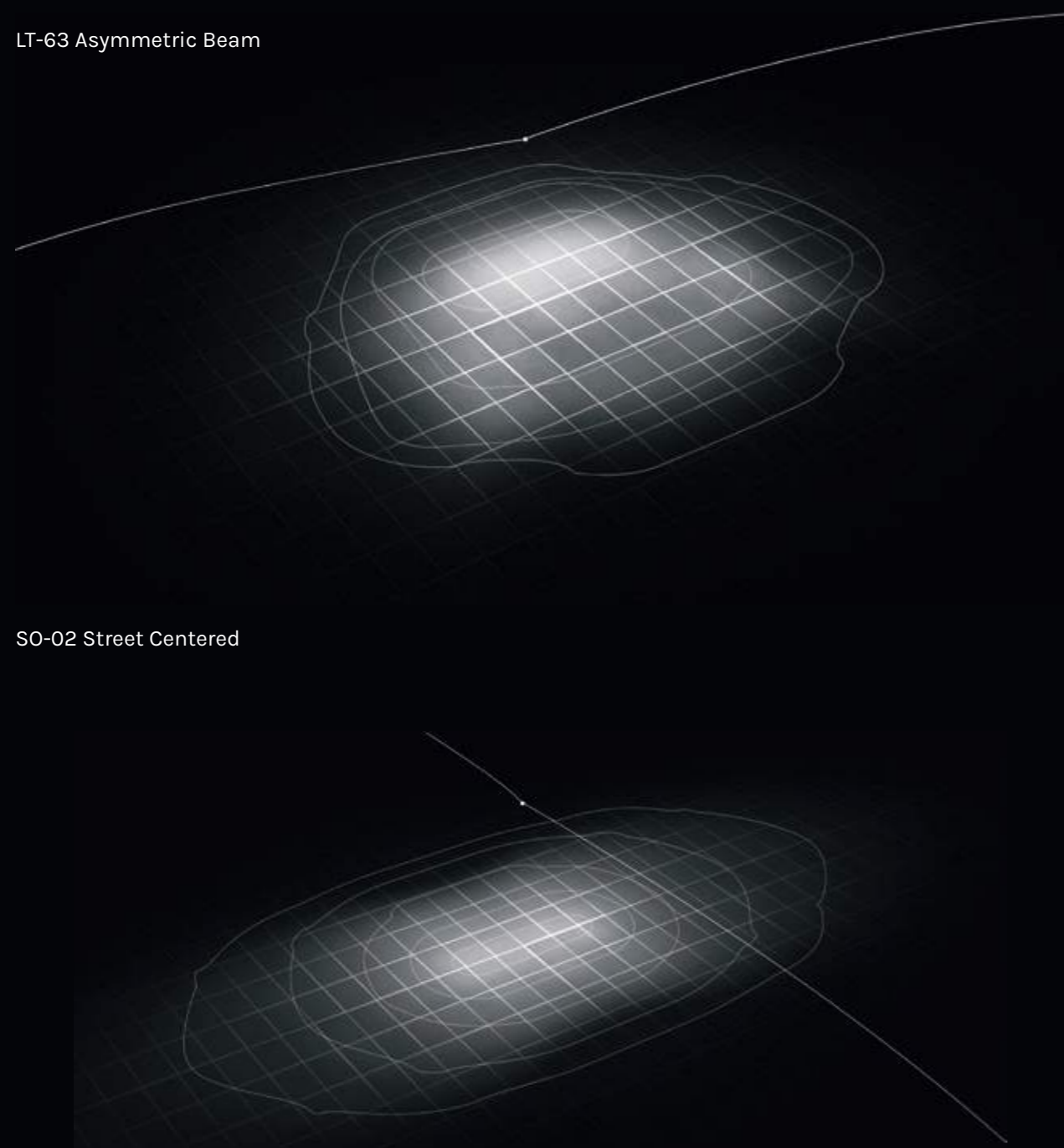

Kosmos
Sospensione tesata
String suspension

DATI TECNICI / TECHNICAL DATA

Installazione / Installation:
sospensione tesata / string suspension

Inclinazione / Inclination:
orizzontale $\pm 15^\circ$ / horizontal $\pm 15^\circ$

Orientabilità / Adjustability:
 $0^\circ + 360^\circ$

**TEMPERATURA COLORE
COLOUR TEMPERATURE**

- 2200 K
- 3000 K
- 4000 K

SMALL

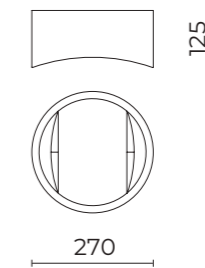

MEDIUM

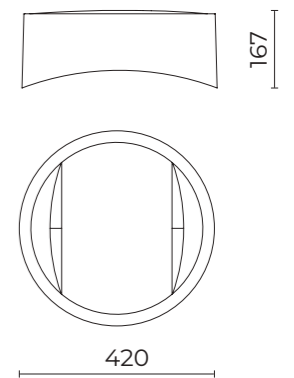

ACCESSORI / ACCESSORIES

06KS902C0
B80 - Kit sospensione su
fune tesata $\varnothing 6 \div 12$ mm
Suspension kit for string $\varnothing 6 \div 12$ mm

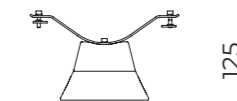

06ND901Y0
Diffusore policarbonato trasparente
Kosmos small
Transparent polycarbonate diffuser
Kosmos small

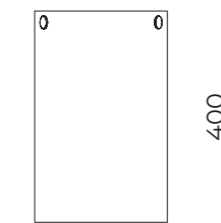

$\varnothing 250$



OTTICHE / OPTICS

LT-C1 Cycle Path
L / H = 0,5

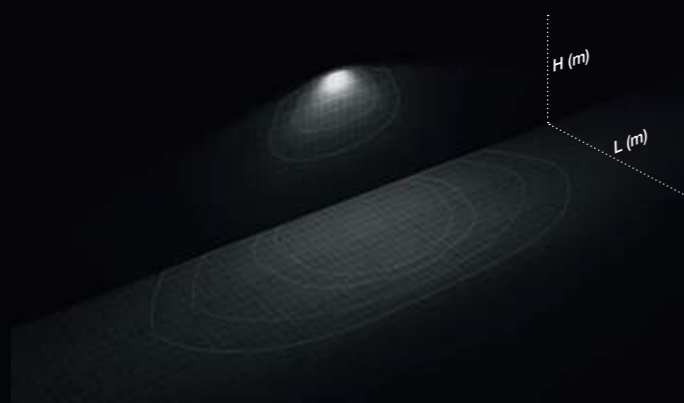

LA-03 Wide Street
L / H = 1,25

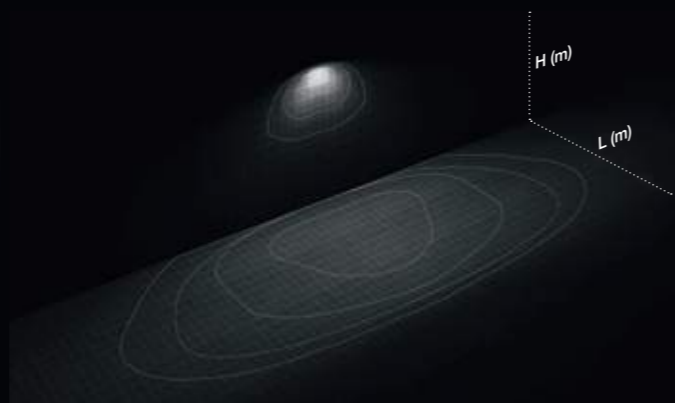

ST-02 Narrow Street
L / H = 0,75

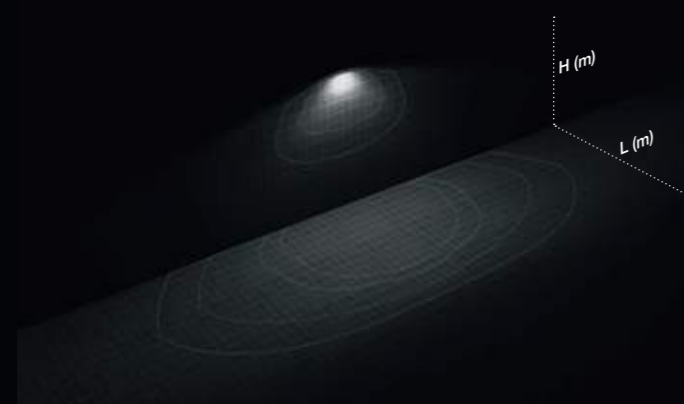

PB-01 Low Pole
L / H = 2

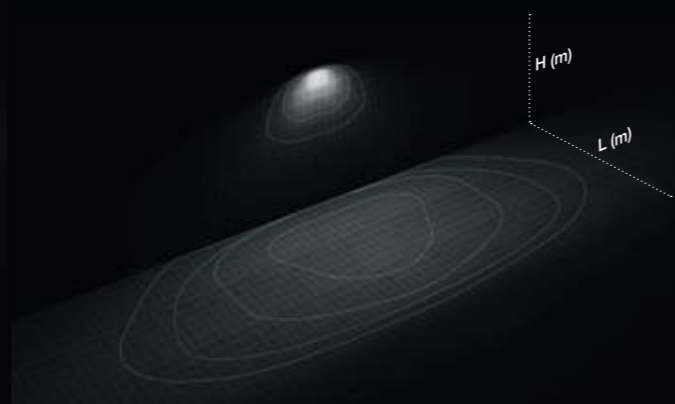

ME-05 Medium Street
L / H = 1

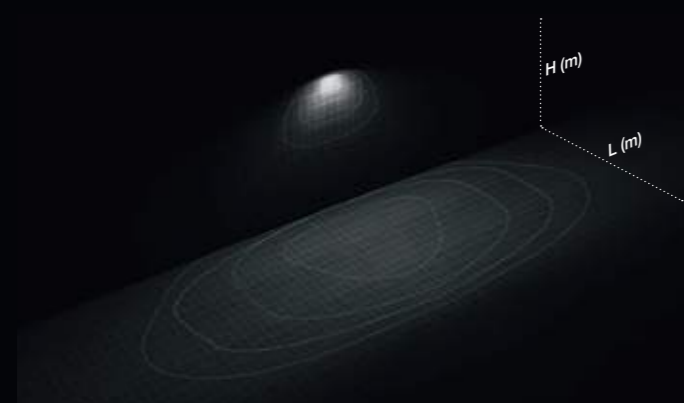

LT-63 Asymmetric Beam
L / H = 2

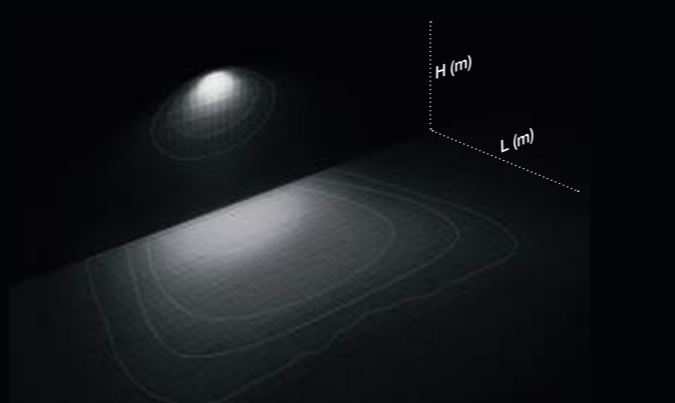

Kosmos
Parete / Wall

DATI TECNICI / TECHNICAL DATA

Installazione / Installation:
su bracci a parete / on wall-mounted arms

Inclinazione / Inclination:
regolazione -10° ÷ +190° (in step da 5°)
adjustment -10° ÷ +190° (step 5°)



TEMPERATURA COLORE
COLOUR TEMPERATURE

- 3000 K
- 4000 K

SMALL

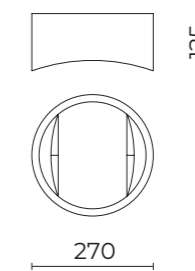

MEDIUM

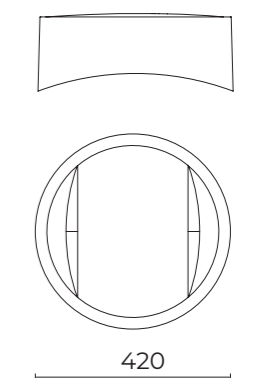

ACCESSORI / ACCESSORIES

06KS905C0
B85-P - Braccio parete
Arm for wall-mounting

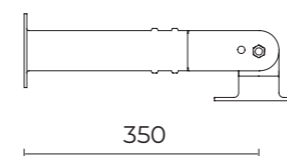

06KS904C0
B84 - Snodo per bracci
Joint for arms

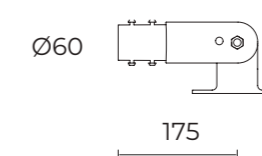

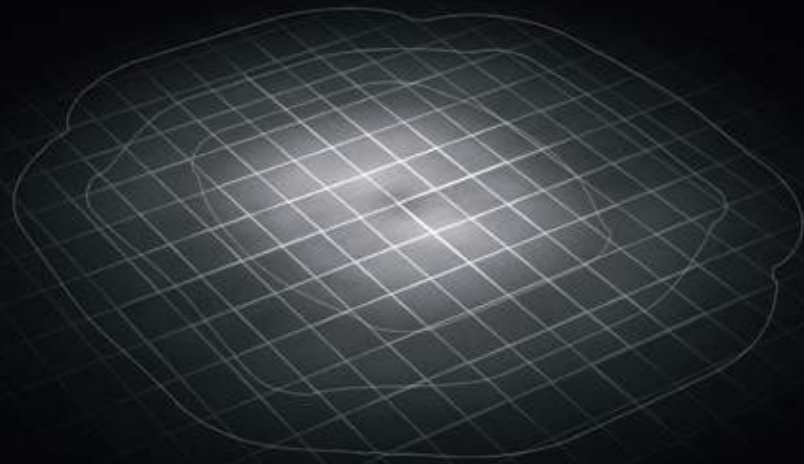

Kosmos
Soffitto / Ceiling

Cariboni Group

DATI TECNICI / TECHNICAL DATA

Installazione / Installation:
soffitto, sottoportico
ceiling, arcade

Inclinazione / Inclination:
regolazione -10° ÷ +190° (in step da 5°)
adjustment -10° ÷ +190° (step 5°)



TEMPERATURA COLORE
COLOUR TEMPERATURE

● 3000 K

○ 4000 K

SMALL

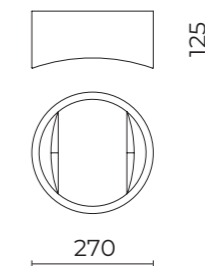

MEDIUM

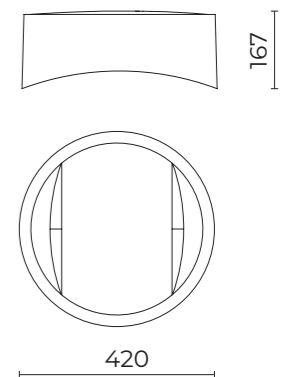

ACCESSORI / ACCESSORIES

06KS905C0
B85-P - Attacco soffitto, sottoportico
Ceiling or arcade mounted

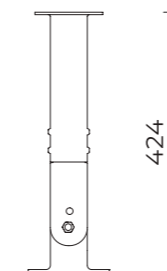

06ND901Y0
Diffusore policarbonato trasparente Kosmos small
Transparent polycarbonate diffuser Kosmos small

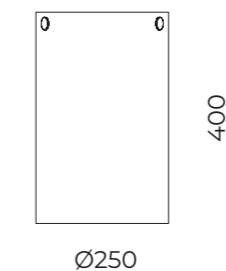

LT-63 Asymmetric Beam
L / H = 2

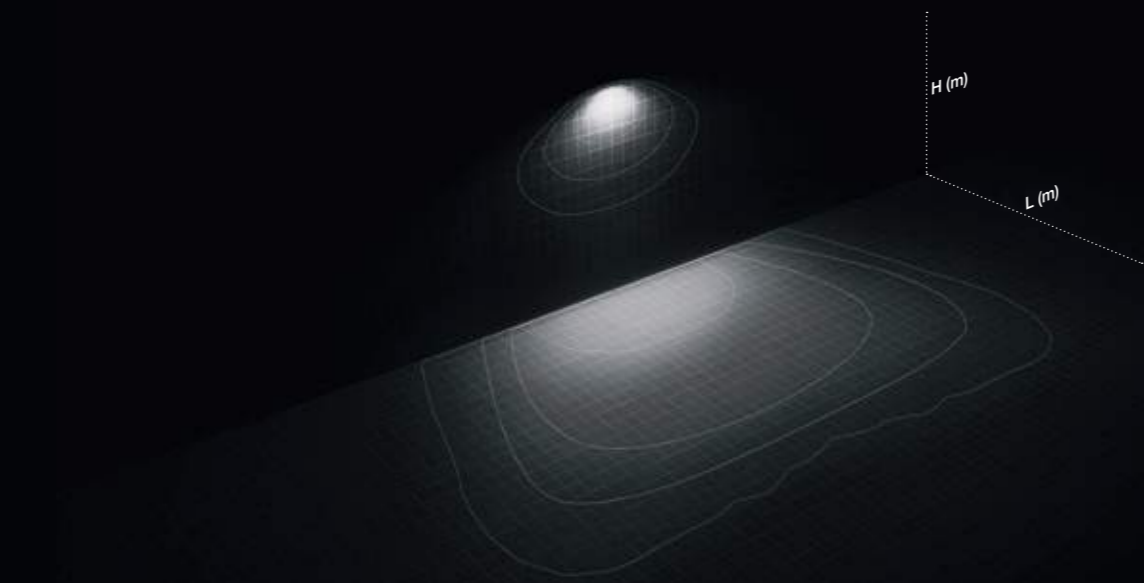

LR-20 Medium Beam

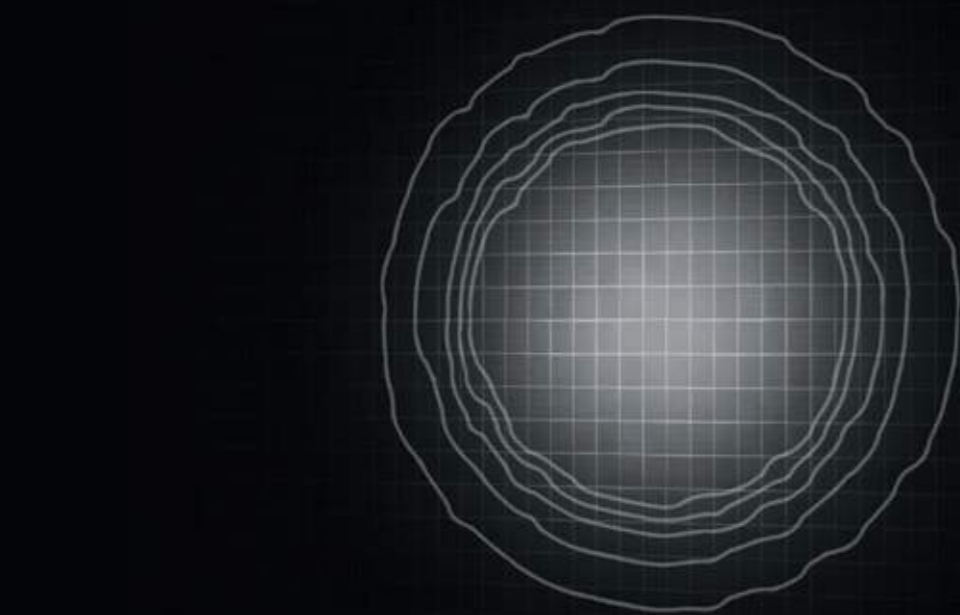

Kosmos Flood

DATI TECNICI / TECHNICAL DATA

Peso massimo / Max weight:
4,2 kg (small), 9,2 kg (medium)

Installazione / Installation:
superfici orizzontali e verticali
horizontal and vertical surfaces

Inclinazione / Inclination:
regolazione continua -25° ÷ +205°
continuous adjustment -25° ÷ +205°

SMALL

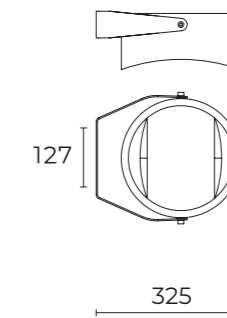

MEDIUM

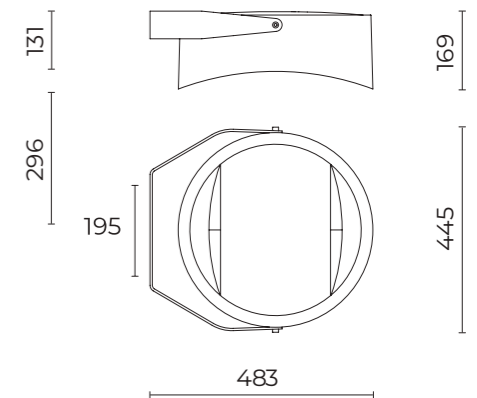

TEMPERATURA COLORE COLOUR TEMPERATURE

- 2200 K
- 3000 K
- 4000 K



LT-63 Asymmetric Beam
L / H = 2

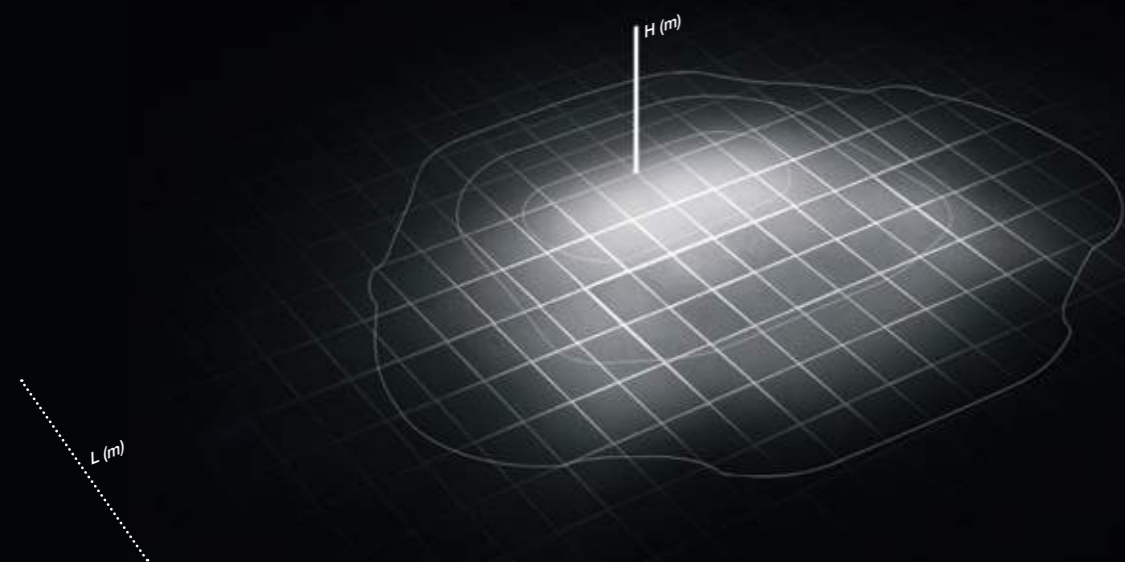

LR-20 Medium Beam

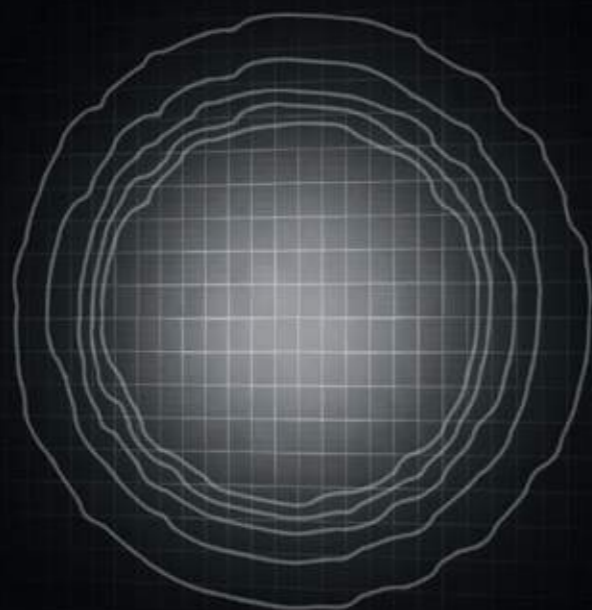

Kosmos
Flood

DATI TECNICI / TECHNICAL DATA

Installazione / Installation:
con accessori su pali Ø 60 - 76 - 102 mm
with accessories on poles Ø 60 - 76 - 102 mm

Inclinazione / Inclination:
regolazione continua -25° ÷ +205°
continuous adjustment -25° ÷ +205°

TEMPERATURA COLORE
COLOUR TEMPERATURE

- 2200 K
- 3000 K
- 4000 K

ACCESSORI / ACCESSORIES

06KS916C0
B78 - Kit attacco staffa-palo
Attachment kit for bracket-pole

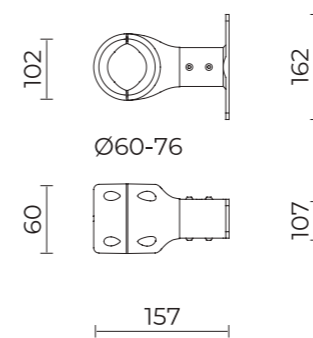

06KS917C0
B97 - Kit attacco staffa-palo
Attachment kit for bracket-pole

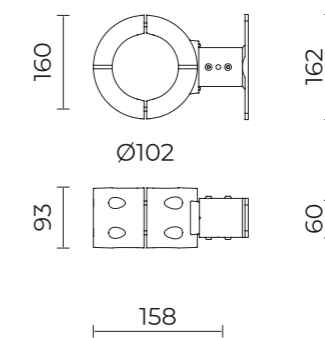

Metalmek Lighting B.V

Canadabaan7-d
5388 RT Nistelrode
Tel. 0412-614033

info@metalmek.nl
www.metalmek.nl

Metalmek

Cariboni
group

 **LIVAL**

NORDIC  **ALUMINIUM**