

N3

EKLEIPSIS

EKLEIPSIS sembra modellata dalla sua stessa luce, come se la luce avesse eroso il metallo in cui era imprigionata per uscirne fuori morbidamente.

EKLEIPSIS seems to be modelled by his own light, as if the light had eroded the metal in which it was imprisoned to come out softly.







* Bollard, pole

** Bollard small

DATI PRESTAZIONALI / PERFORMANCE DATA**Flusso apparecchio / Fitting flux:**

444 - 2073 lm

Potenza apparecchio / Fitting power:

13 - 50 W

Indice di resa cromatica / Colour Rendering Index:

CRI ≥ 80, SDCM ≤ 3

Illuminazione intelligente / Smart lighting:DALI su richiesta (medium, large) / DALI on request
(medium, large)**TEMPERATURA COLORE
COLOUR TEMPERATURE**

2700 K

3000 K

4000 K

MATERIALI / MATERIALS**Corpo / Body:**pressofusione di lega d'alluminio UNI EN AB 47100
(contenuto rame < 1%), palo in alluminio estruso
die-cast aluminum alloy UNI EN AB 47100 (copper
content < 1%) extruded aluminium pole**Gruppo ottico / Optical unit:**

lente in policarbonato / polycarbonate lens

Finitura / Finish:fosfocromatazione e verniciatura in polveri di poliestere
realizzata in 16 fasi per la miglior resistenza agli
agenti atmosferici / phospho-chromatation treated
and polyester powder-coated in 16 phases to increase
weather resistance**CARATTERISTICHE / FEATURES****Alimentazione elettronica / Electronic power supply:**

inclusa / included

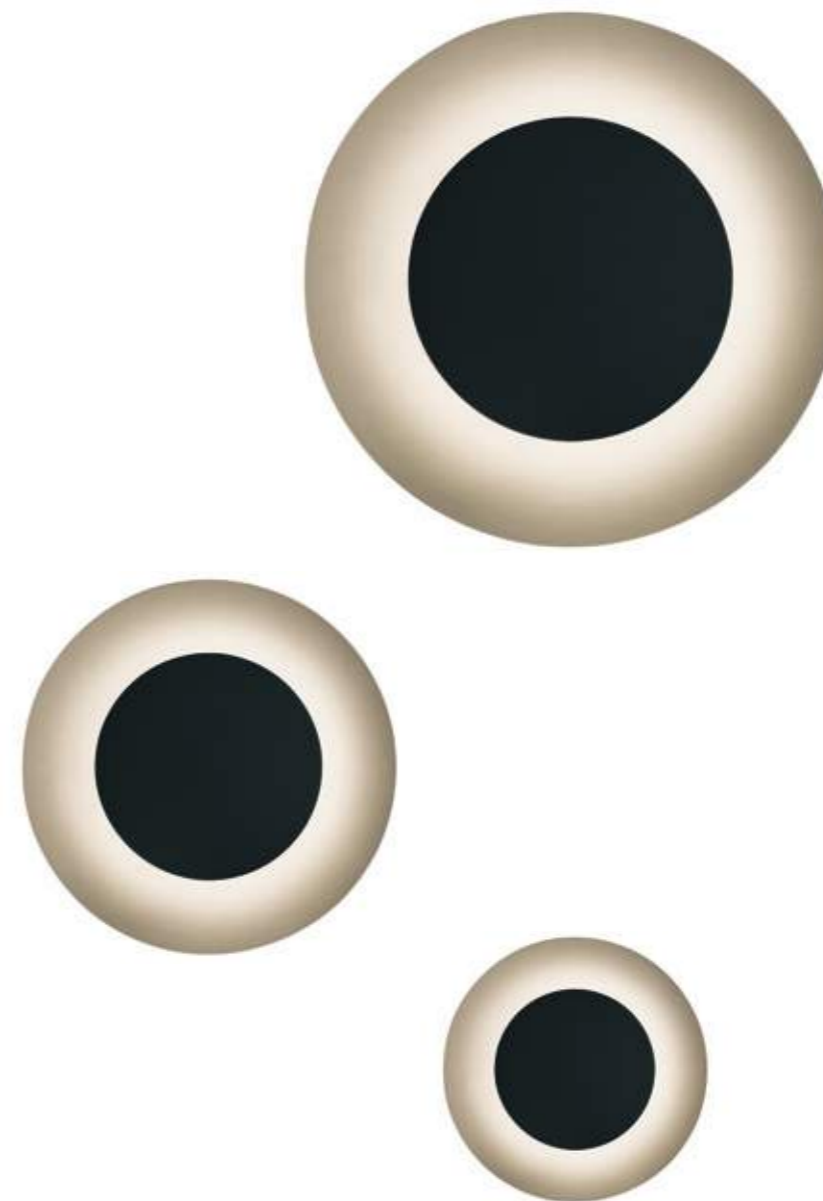
Installazione / Installation:parete, soffitto, bollard, palo / wall, ceiling,
bollard, pole



Ekleipsis

Parete / Wall



SMALL

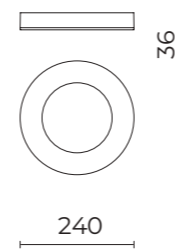

MEDIUM

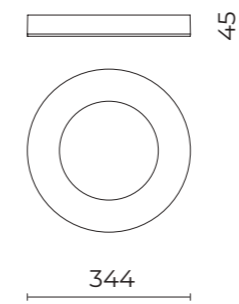

LARGE

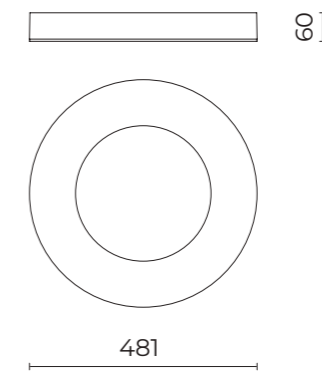

DATI TECNICI / TECHNICAL DATA

Peso massimo / Max weight:
1,3 kg (small), 2,4 kg (medium), 5 kg (large)

Installazione / Installation:
parete / wall-mounted

COLORI / COLOURS

- SABLÉ 100 NOIR
- RAL9006
- RAL9003



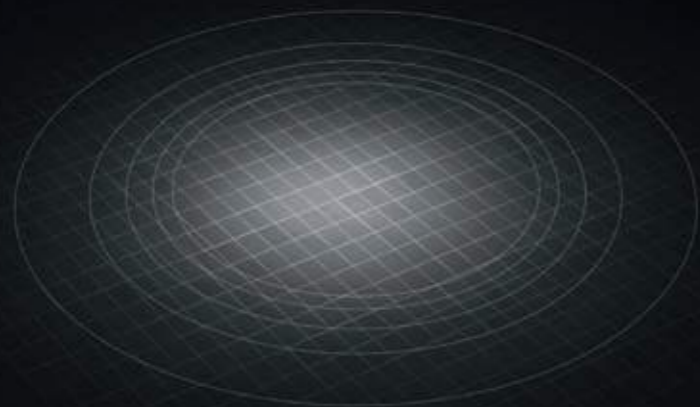

Ekleipsis
Soffitto / Ceiling



SMALL

MEDIUM

LARGE

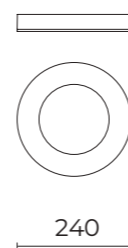

36

240

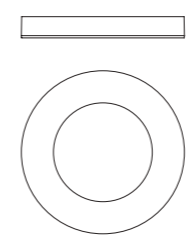

45

344

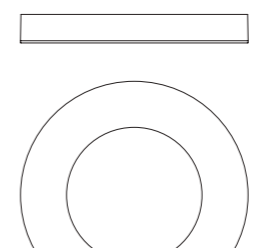

60

481

DATI TECNICI / TECHNICAL DATA

Peso massimo / Max weight:
1,3 kg (small), 2,4 kg (medium), 5 kg (large)

Installazione / Installation:
soffitto / ceiling-mounted

COLORI / COLOURS

-  SABLÉ 100 NOIR
-  RAL9006
-  RAL9003



OTTICHE / OPTICS

R-D Rotosymmetric Diffused Beam

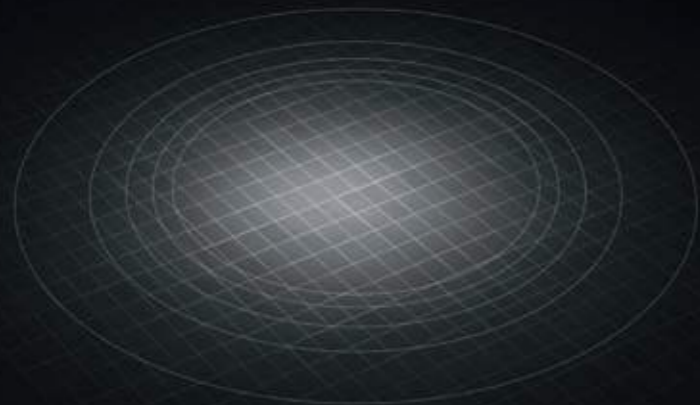

Ekleipsis

Incasso soffitto / Ceiling recessed

SMALL

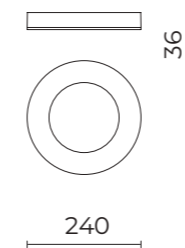

MEDIUM

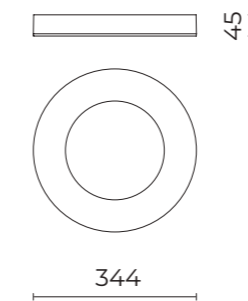

LARGE

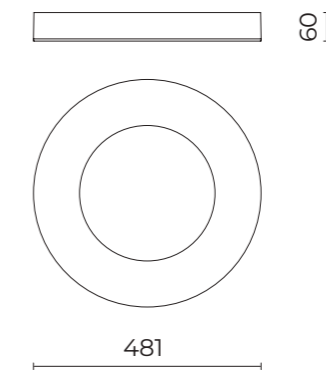



DATI TECNICI / TECHNICAL DATA

Peso massimo / Max weight:
1,3 kg (small), 2,4 kg (medium), 5 kg (large)

Installazione / Installation:
incasso soffitto / ceiling-recessed

COLORI / COLOURS

-  SABLÉ 100 NOIR
-  RAL9006
-  RAL9003

ACCESSORI / ACCESSORIES

Kit incasso per soffitti in cartongesso
Recessed kit for plasterboard ceilings

06EK900J
Small

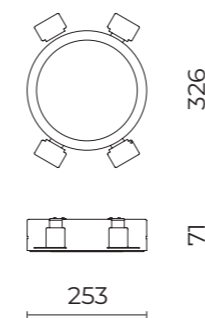

06EK901J
Medium

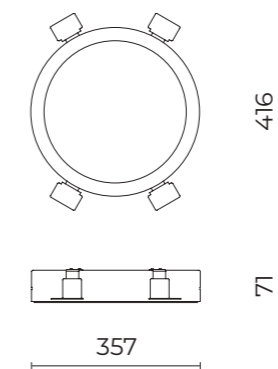

06EK902J
Large

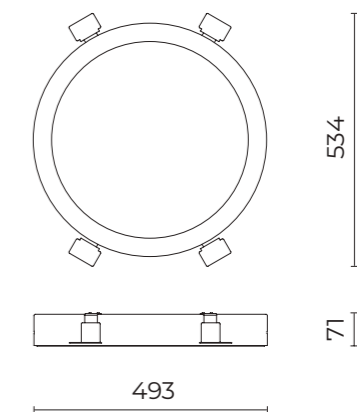



SUKOŠAN
Croatia



BRATISLAVA
Slovakia



BERGAMO
Italy



VIC
Spain

R-D Rotosymmetric Diffused Beam

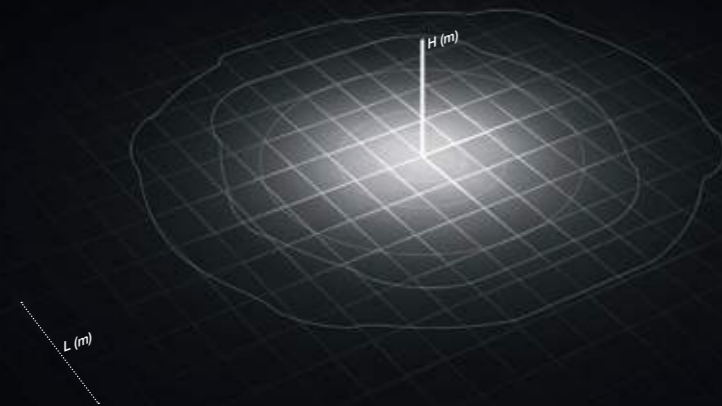

Ekleipsis Bollard

SMALL 500

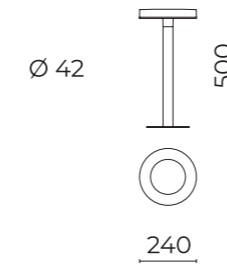

SMALL 1000

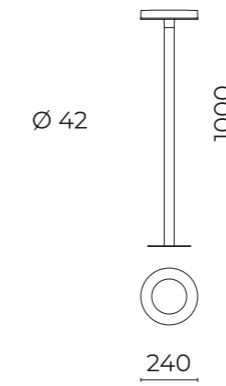

MEDIUM 1000

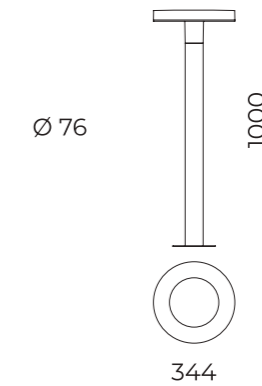

DATI TECNICI / TECHNICAL DATA

Peso massimo / Max weight:
7,5 kg (small), 16 kg (medium)

Protezione contro le sovratensioni
Surge Protection Device:
MC 6 kV (small), 3 kV (medium)
MD 10 kV (small), 8 kV (medium)

Installazione / Installation:
terra, con piastra di base
ground, with base plate

COLORI / COLOURS

- SABLÉ 100 NOIR
- RAL9006

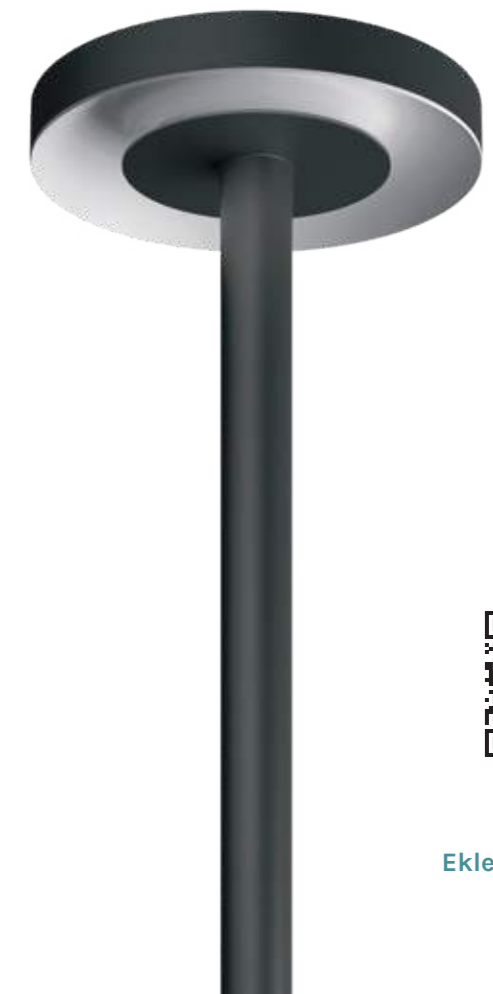

OTTICHE / OPTICS

R-D Rotosymmetric Diffused Beam

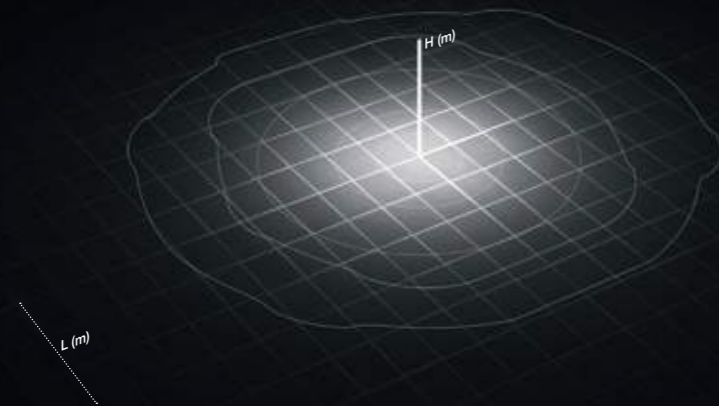

Ekleipsis
Palo / Pole

MEDIUM

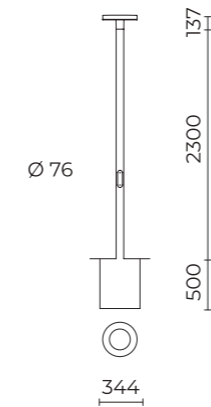

LARGE

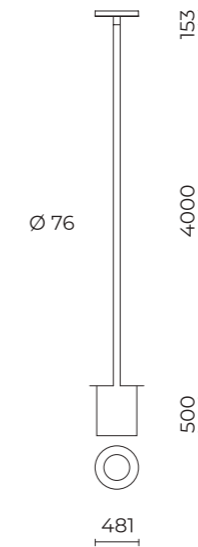

DATI TECNICI / TECHNICAL DATA

Peso massimo / Max weight:
16 kg (medium), 34 kg (large)

Protezione contro le sovratensioni
Surge Protection Device:
MC 3 kV (medium), 4 kV (large)
MD 8 kV

Installazione / Installation:
terra, mediante interrimento
ground, with buried pole

COLORI / COLOURS

- SABLÉ 100 NOIR
- RAL9006



Metalmek Lighting B.V

Canadabaan7-d
5388 RT Nistelrode
Tel. 0412-614033

info@metalmek.nl
www.metalmek.nl

Metalmek

Cariboni
group

 **LIVAL**

NORDIC  **ALUMINIUM**