

N3

AGATHOS



AGATHOS è una lanterna dalle forme tradizionali ma progettata specificatamente per alloggiare la più innovativa tecnologia LED.

AGHATOS is a lantern with traditional shapes but specifically designed to house the most innovative led technology.



MONZA
Italy



PORTO VENERE
Italy



BUSSETO
Italy



TURKU
Finland

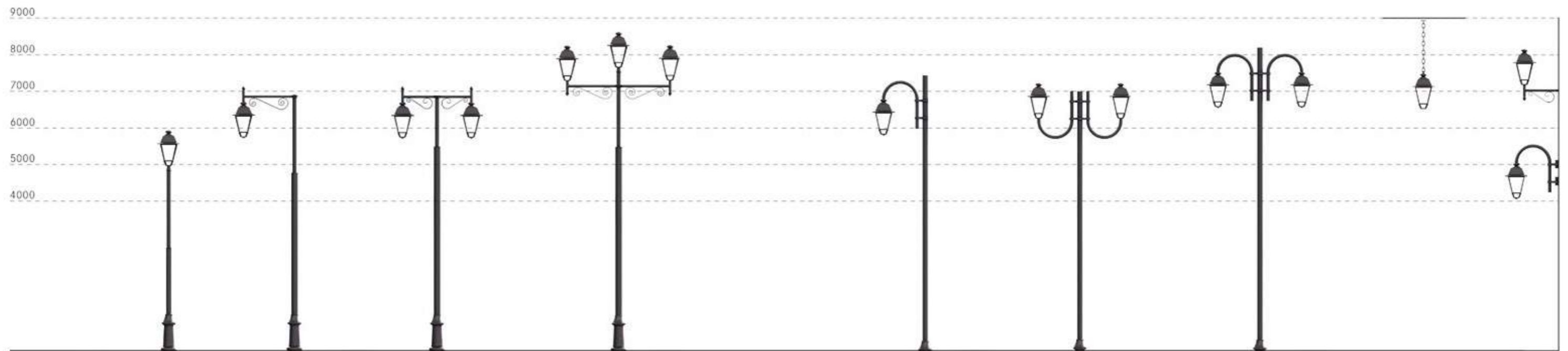

220 240V	50 60Hz	CL II	IP66	IK08	ta -30°C +50°C
-------------	------------	-------	------	------	----------------------



DATI PRESTAZIONALI / PERFORMANCE DATA

Flusso apparecchio / Fitting flux:
1355 (1800 K) - 10835 lm

Potenza apparecchio / Fitting power:
12 - 78 W

Indice di resa cromatica / Colour Rendering Index:
CRI ≥ 70, SDCM ≤ 3

Illuminazione intelligente / Smart Lighting:
mezzanotte virtuale. Su richiesta DALI, CLO, PLC,
telegestione wireless
virtual midnight. On request DALI, CLO, PLC,
wireless telemanagement

MATERIALI / MATERIALS

Corpo e sistemi di fissaggio / Body and fitting system:
pressofusione di lega d'alluminio UNI EN AB 47100
(contenuto rame < 1%) / die-cast aluminum alloy UNI EN
AB 47100 (copper content < 1%)

Schermo / Screen:
vetro piano temprato / tempered flat glass

Gruppo ottico / Optical unit:
lenti PMMA ad alta trasparenza
high-transparency PMMA lenses

Finitura / Finish:
fosfocromatazione e verniciatura in polveri di poliestere
realizzata in 16 fasi per la miglior resistenza agli
agenti atmosferici / phospho-chromatation treated
and polyester powder-coated in 16 phases to increase
weather resistance

**TEMPERATURA COLORE
COLOUR TEMPERATURE**

- 2200 K
- 2700 K
- 3000 K
- 4000 K

**ECO-CENTRIC LIGHTING (ECL)
(ONLY FOR STREET OPTICS)**

BLUE FREE LIGHT:
PC-AMBER 0,7% ΣR (λ < 500NM) – CRI 40
1800 K 4,3% ΣR (λ < 500NM) – CRI 70

SWITCHABLE WHITE LIGHT:
1800K / 3000K

COLORI / COLOURS

- SABLÉ 100 NOIR

CARATTERISTICHE / FEATURES

Peso massimo / Max weight:
8 kg

Alimentazione elettronica / Electronic power supply:
inclusa / included

Resistenza sovratensioni / Surge Protection Device:
10 kV MC/MD

Installazione / Installation:
testa palo, lato palo, sospensione braccio, parete,
sottoportico / post top, pole side, arm suspension,
wall, arcade



OTTICHE / OPTICS

LT-C1 Cycle Path
L / H = 0,5

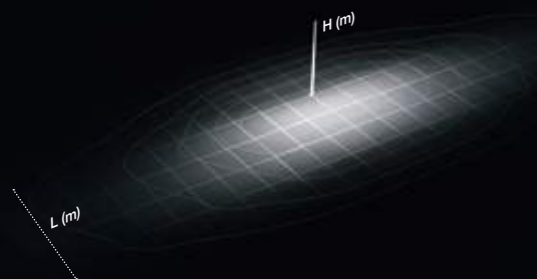

LT-64 Asymmetric Beam with backlight ECL
L / H = 2

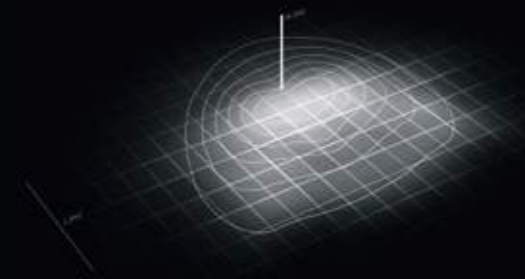

ST-02 Narrow Street ECL
L / H = 0,75

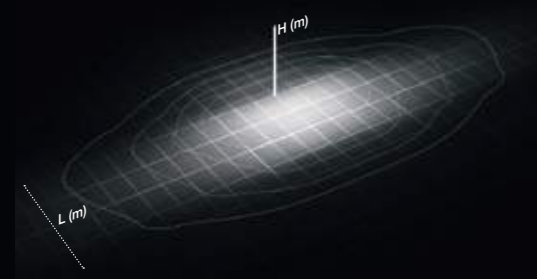

F&B ST-02 + LA-03 Front & Back
L / H = 0,75 + 1,25

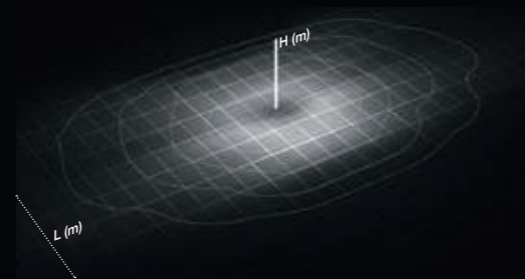

LA-03 Wide Street
L / H = 1,25

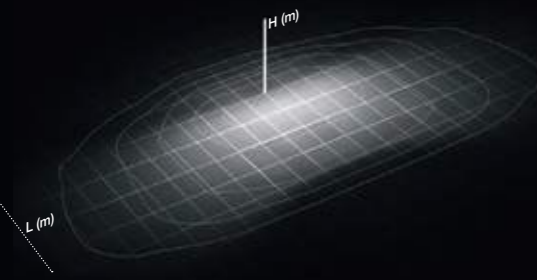

RS-02 Rotosymmetric Beam ECL
L / H = 2

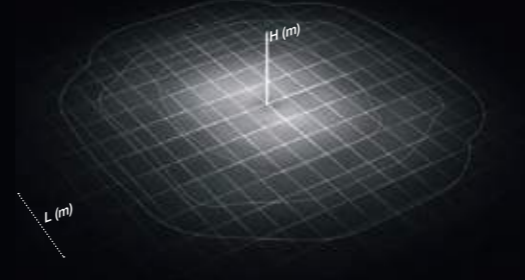

Agathos
Testa palo / Post top

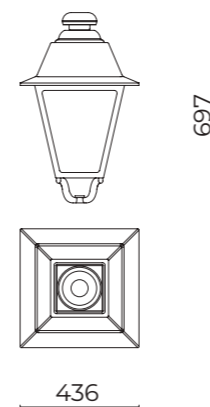

DATI TECNICI / TECHNICAL DATA

Installazione / Installation:
pali con attacco 3/4" GAS maschio, pali cima Ø 60 mm
innesto H 90 mm con accessorio 01AG901CO / poles with
male 3/4" GAS connection, poles with post top Ø 60 mm and
fastening part H 90 mm with accessory 01AG901CO

ACCESSORI / ACCESSORIES

01AG900CO
Kit fissaggio per pali con
attacco 3/4" GAS femmina
Fastening kit on poles with
female 3/4" GAS

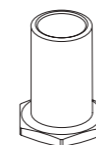

01AG901CO
Kit testa palo codolo H 90 mm
Fastening kit post top H 90 mm



Ø60



OTTICHE / OPTICS

ST-02 Narrow Street
L / H = 0,75

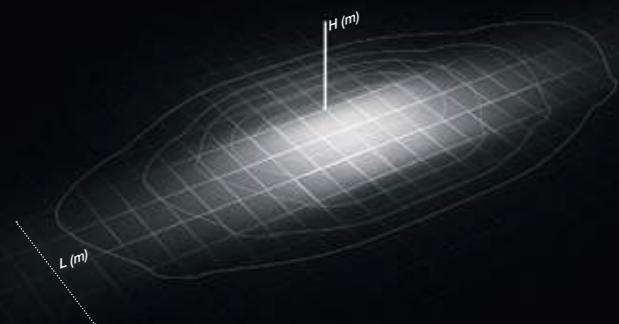

LT-64 Asymmetric Beam with backlight
L / H = 2

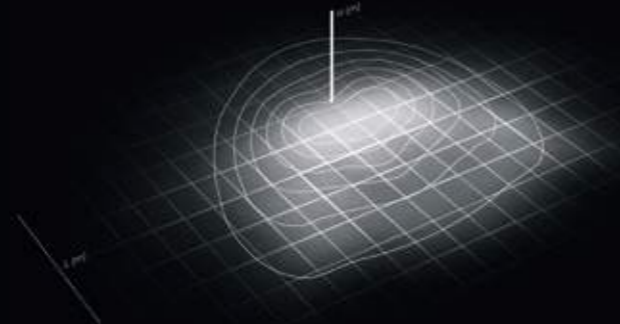

LA-03 Wide Street
L / H = 1,25

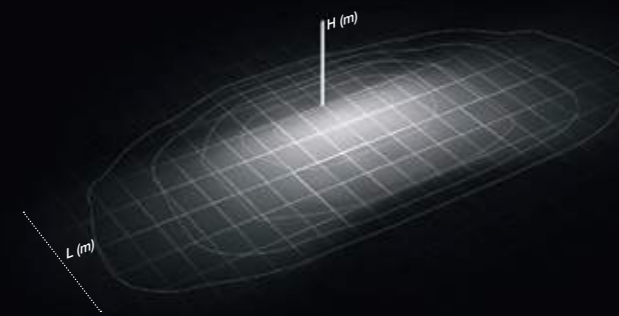

Agathos

Lato palo / Pole side

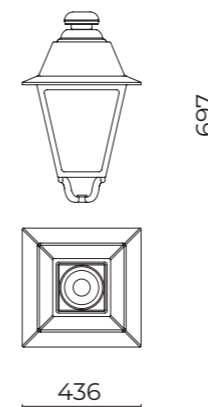

DATI TECNICI / TECHNICAL DATA

Installazione / Installation:
su bracci con attacco 3/4" GAS maschio
on arms with male 3/4" GAS connection

ACCESSORI / ACCESSORIES

01AG900CO
Kit fissaggio per bracci UP con attacco 3/4" GAS femmina
Fastening kit on UP arms with female 3/4" GAS

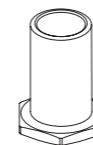

Agathos

Lato palo / Pole side

BRACCI / ARMS

01AG910CO
B60 - Braccio pastorale UP
Curved arm UP

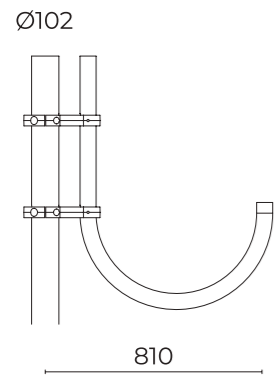

01AG911CO
B61 - Braccio pastorale doppio UP
Double curved arm UP

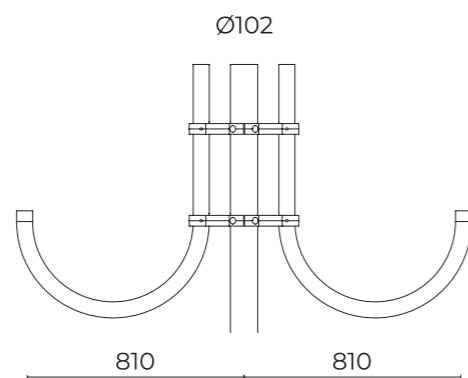

01AG914CO
B64 - Braccio UP
Arm UP

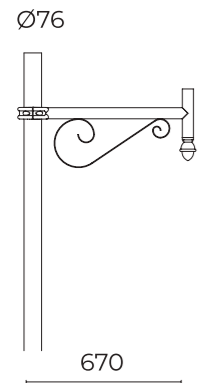

01AG918CO
B68 - Braccio doppio UP
Double arm UP

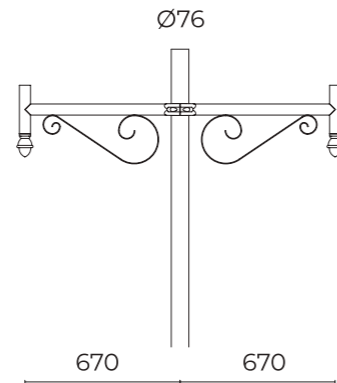

01AG915CO
B65 - Braccio UP
Arm UP

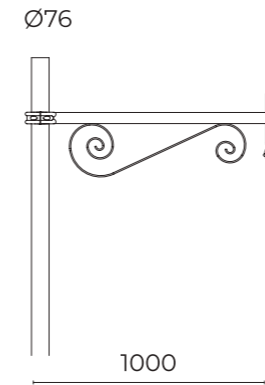

01AG919CO
B69 - Braccio doppio UP
Double arm UP

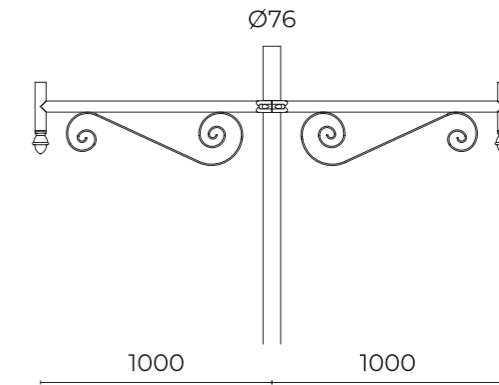

ACCESSORI / ACCESSORIES

01AK970CO
Collarino per palo
Collar for pole

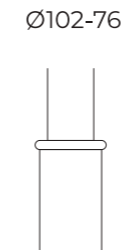

01AK971CO
Collarino per palo
Collar for pole

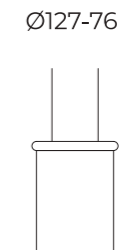

01AK972CO
Basamento basso
Low base

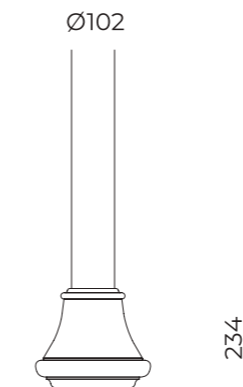

01AK973CO
Basamento alto
High base

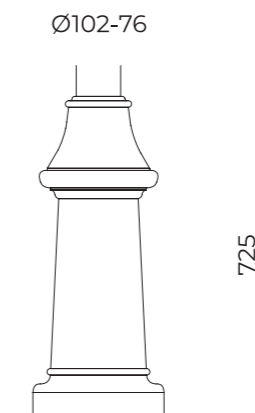

01AK974CO
Basamento alto
High base

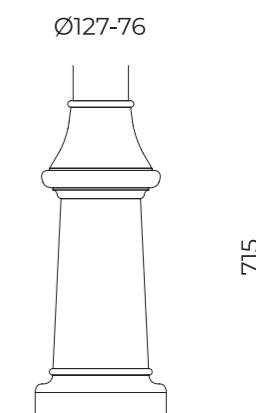

ST-02 Narrow Street
L / H = 0,75

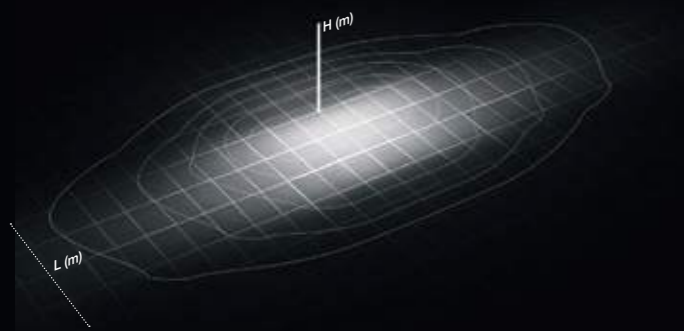

LT-64 Asymmetric Beam with backlight
L / H = 2

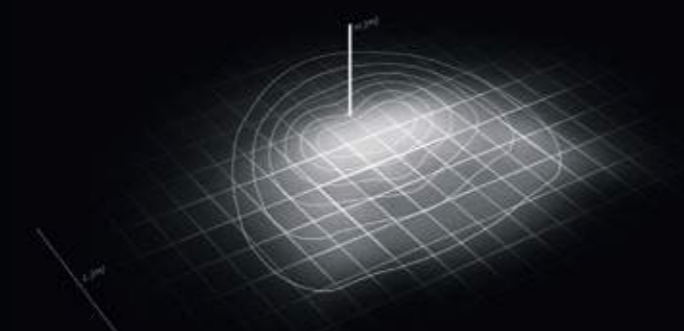

LA-03 Wide Street
L / H = 1,25

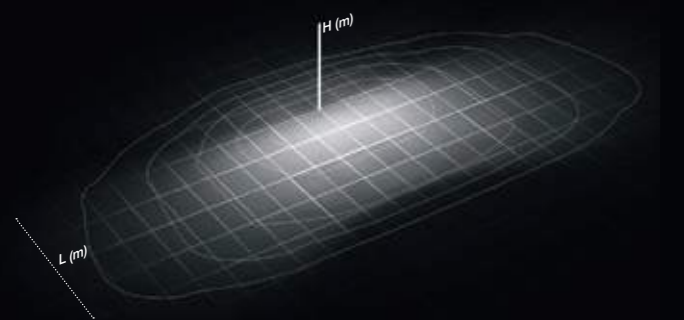

Agathos
Sospensione braccio
Arm suspension

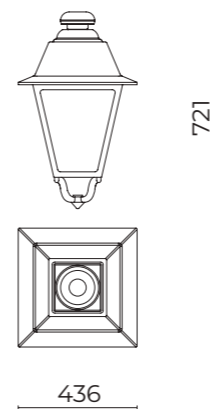

DATI TECNICI / TECHNICAL DATA

Installazione / Installation:
su bracci con attacco 3/4" GAS femmina
on arms with female 3/4" GAS connection



Agathos

Sospensione braccio / Arm suspension

BRACCI / ARMS

01AG910CO
B62 - Braccio pastorale DOWN
 Curved arm DOWN

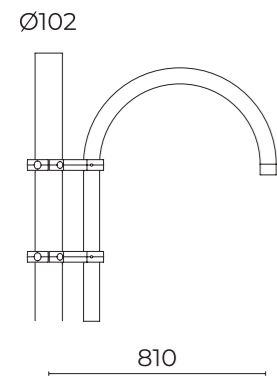

01AG911CO
B63 - Braccio pastorale doppio DOWN
 Double curved arm DOWN

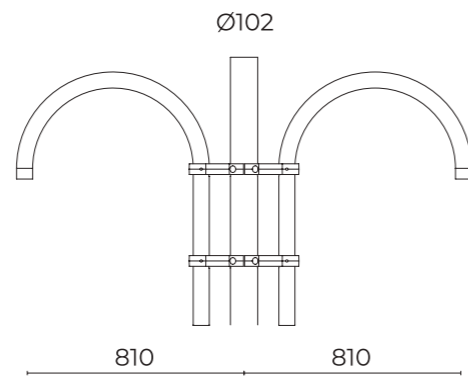

01AG914CO
B66 - Braccio DOWN
 Arm DOWN

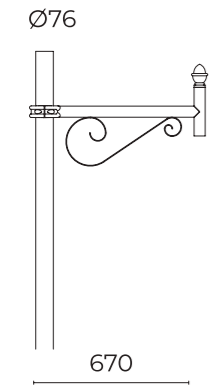

01AG918CO
B70 - Braccio doppio DOWN
 Double arm DOWN

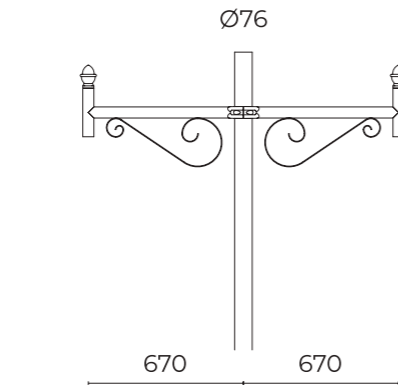

01AG915CO
B67 - Braccio DOWN
 Arm DOWN

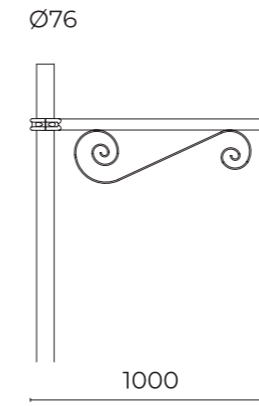

01AG919CO
B71 - Braccio doppio DOWN
 Double arm DOWN

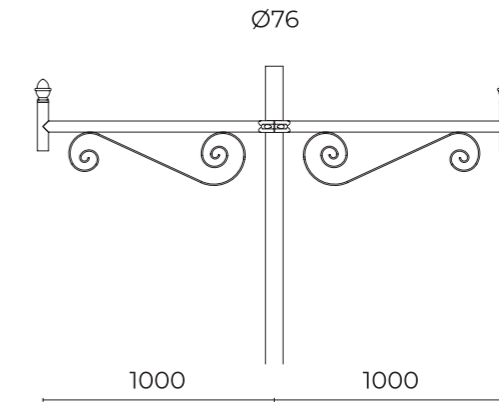

ACCESSORI / ACCESSORIES

01AK970CO
Collarino per palo
 Collar for pole

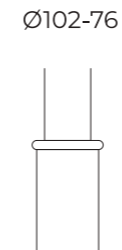

01AK971CO
Collarino per palo
 Collar for pole

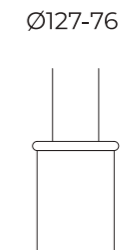

01AK972CO
Basamento basso
 Low base

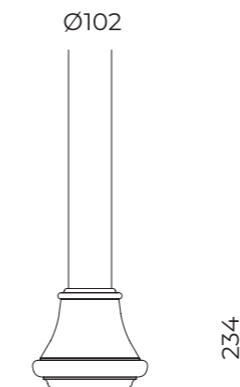

01AK973CO
Basamento alto
 High base

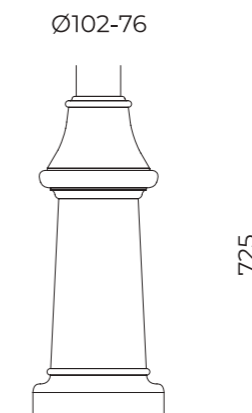

01AK974CO
Basamento alto
 High base

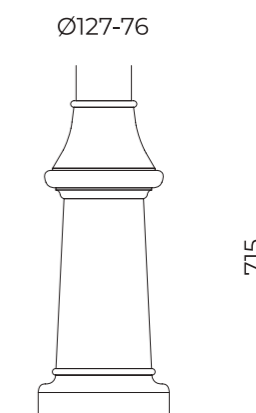

OTTICHE / OPTICS

ST-02 Narrow Street
L / H = 0,75

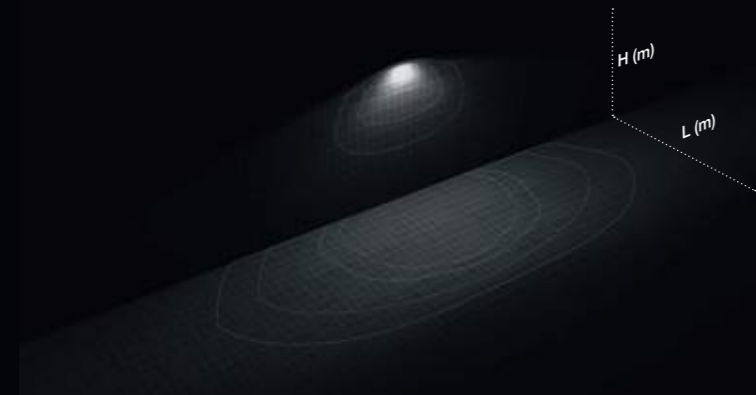

LT-63 Asymmetric Beam
L / H = 2

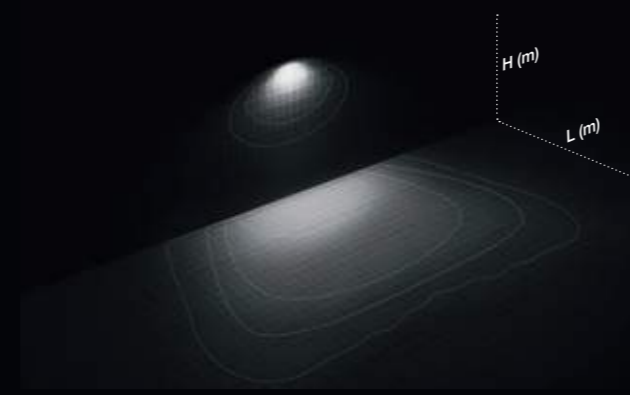

LA-03 Wide Street
L / H = 1,25



Agathos
Parete / Wall

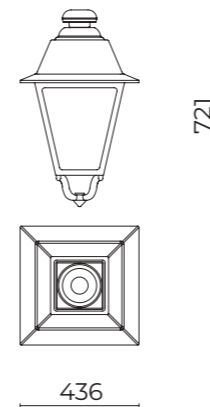

DATI TECNICI / TECHNICAL DATA

Installazione / Installation:
su bracci a parete / on wall-mounted arms

ACCESSORI / ACCESSORIES

01AG900CO
Kit fissaggio per bracci UP con attacco 3/4" GAS femmina
Fastening kit on UP arms with female 3/4" GAS

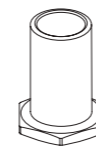

Agathos
Parete / Wall

BRACCI / ARMS

01AG922CO
B60-P - Braccio
pastorale UP
Bracket UP

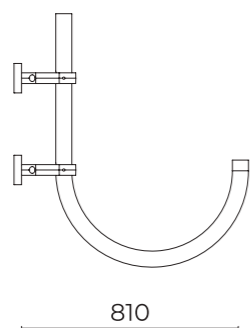

01AG923CO
B62-P - Braccio
pastorale DOWN
Bracket DOWN

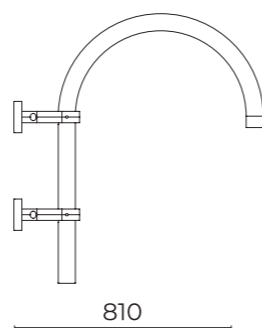

01AG924CO
B64-P - Braccio UP
Bracket UP

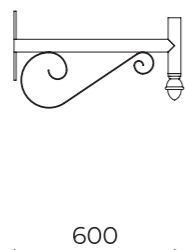

01AG925CO
B65-P - Braccio UP
Bracket UP

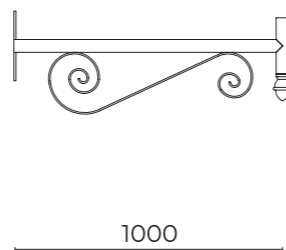

01AG926CO
B66-P - Braccio DOWN
Bracket DOWN

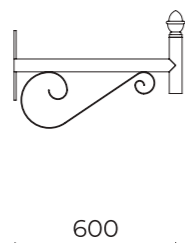

01AG927CO
B67-P - Braccio DOWN
Bracket DOWN

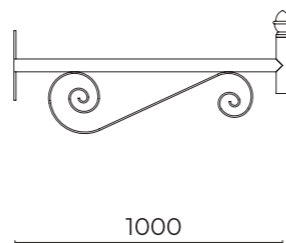

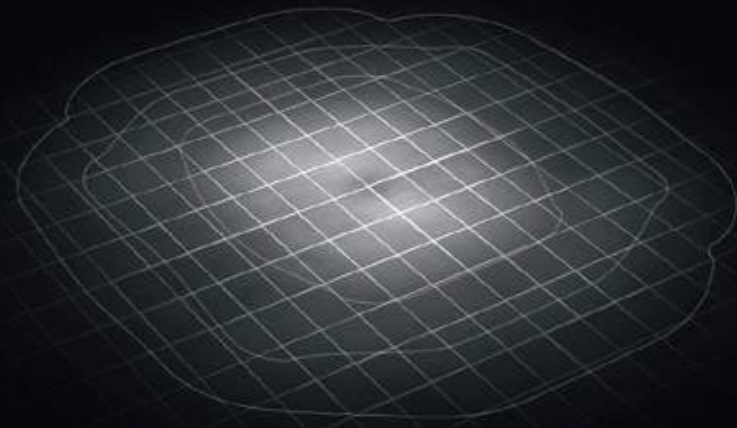

Agathos
Sottoportico / Arcade

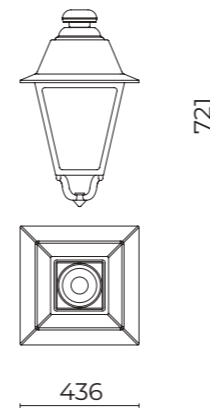

ACCESSORI / ACCESSORIES

01AG903CO
Gancio per sospensione su catena (non compresa)
Suspension hook on chain (not included)

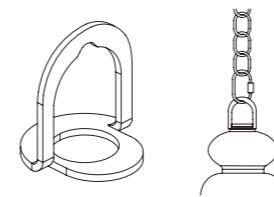

Metalmek Lighting B.V

Canadabaan7-d
5388 RT Nistelrode
Tel. 0412-614033

info@metalmek.nl
www.metalmek.nl

Metalmek

Cariboni
group

 **LIVAL**

NORDIC  **ALUMINIUM**